

# Visible Light Communication Development Kits Compliant to CP1223 Standard

Petch Nantivatana<sup>1</sup>, Kata Jaruwongrungrsee<sup>2</sup>, Termpong Srited<sup>1</sup>, Piya Kovintavewat<sup>3</sup>, and Preecha Kocharoen<sup>1</sup>

<sup>1</sup> Study and Applied Research Group on Microcontroller, Electronics and Telecommunications: SARGMET, Faculty of Engineering, Sripatum University, 2410/2 Phaholyothin Road, Jatujak, Bangkok, Thailand, 10900

<sup>2</sup> Nanoelectronics and MEMS Laboratory, National Electronic and Computer Technology Center (NECTEC), Thailand.

<sup>3</sup> Data Storage Technology Research Center, Nakhon Pathom Rajabhat University, Nakhon Pathom 73000, Thailand

E-mail: <sup>1</sup>petch.na@spu.ac.th, <sup>2</sup>kata.jaruwongrungrsee@nectec.or.th, <sup>3</sup>piya@npru.ac.th

## Abstract:

The guideline of development platform both hardware and software for CP1223 standard has been introduced to accelerate the development of visible light communication (VLC) technology in Thailand. This development kit was developed by SARGMET researchers, which could be used to expedite the production time to market for industrial partners. The hardware is developed from the Arduino Pro micro (mini Leonardo) microcontroller, which is used to control a driver and a receiver circuit of the LED light source and the photo diode. The development kit also provides the microcontroller software scripts to create and control the I-4PPM modulation and serial data formatting according to the CP1223 standard defined. This can reduce the time to develop the VLC products with the ease of use and low complexity.

## 1. Introduction

A visible light communication (VLC) technology can utilize the solid state lights, i.e., LED lights to transmit data via light intensity together with illumination. The LED lamps could be installed on the ceiling for illumination covered all places in a building, including room and corridor, or installed in an illuminated advertising board or an emergency exit sign. Information can be retrieved from the LED light based on light intensity. Recently, there are several standards related to VLC. The CP1223 standard [1] was proposed by the VLC consortium, Japan, which prescribes the unidirectional communication system with visible light as the medium for multimedia applications. In addition, the institute of electrical and electronics engineers (IEEE) defines an IEEE 802.15.7 standard [2] for short-range optical wireless communication using visible light. This standard defines only two layers, physical layer (PHY) and medium access control layer (MAC) in the OSI 7-layers model.

To accelerate the VLC technology development, the guideline of development platform both hardware and software are needed. Therefore, the VLC development kit that in compliance with CP1223 standard has been developed in order to accelerate the production time to market for industrial partners. This paper focuses only on the VLC development kit based on the CP1223 standard.

## 2. CP1223 Standard

The CP1223 standard is introduced for a visible light beacon system for multimedia applications. Generally, it describes a unidirectional communication system with visible light as a medium. The communication model for this standard is simple, consisting of two types of devices,

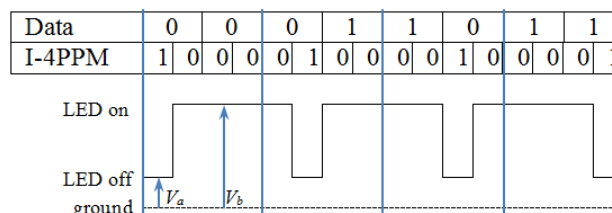

Figure 1. I-4PPM signal waveform.

which are visible light transmitter and visible light receiver. The light transmitter can transmit information either arbitrary data or an ID code in a beacon frame form through a lower communication layer, while the light receiver receives information beacon directly from the transmitter and then decodes to retrieve the information. The lower communication layer in the CP1223 standard composes of two layers, which are a physical layer and a frame layer. However, data or ID code are in the higher communication layer that is not included in the CP1223 standard.

### 2.1 Physical layer

An optical wavelength of this system is around 380 – 780 nm with data rate of 4.8 kbps and its tolerance of data rate shall be no more than 0.5%. The transmission system for modulation of visible light is Inverted - 4 Pulse Position Modulation (I-4PPM) as shown in Figure 1. In the Figure 1, the voltage signal in ‘LED on’ stage is  $V_b$ , while the voltage signal in ‘LED off’ stage is  $V_a$ .

### 2.2 Frame layer

In frame layer or data link layer, the frame consists of start of the frame (SOF), payload, and end of frame (EOF). The SOF composes of the preamble (PRE) and the frame-type (F-TYPE), where the payload contains ID information and/or data. The EOF is the cyclic redundancy check (CRC-16). The 20 octets frame structure of CP1223 is shown in Figure 2. The 6-bits preamble is divided into 3 of ‘1’ and 9 of ‘0’ pulses to create optical pulses as shown in Figure 3. This preamble is different from all I-4PPM code; therefore, it can be used to classified the start of frame from the received sequences.

After a preamble sequence, the type or the purpose of the data payload usage is shown with 8 bits length. For experimental purpose, the frame type is set to ‘00h’. In the payload segment, ID code or data can be transmitted up to 128 bits. Both ID code and data can be transmitted all together in the payload segment or they can be transmitted individually. If both ID code and data are transmitted together, the total length of the payload is still strictly 128 bits.

Start of Frame (SOF)		Payload	End of Frame (EOF)
PRE (6 bits)	FTYPE (8 bits)		CRC-16 (16 bits)
		ID/DATA (128 bits)	

Figure 2. Frame structure.

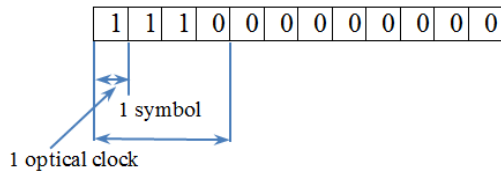

Figure 3. Preamble sequence.

At the end of frame, 16-bits error checking sequence is calculated from the frame type and payload data using CRC-16 generator polynomial ( $x^{16} + x^{15} + x^2 + 1$ ).

The CP1223 frame length is 158 bits, which are encoded using I-4PPM as illustrated in Figure 1. Between two consequences transmitting frames, the transmitter should send something to avoid flicker. There are two methods to transmit the signals between frames that are transmitting all 128-bit data with '0' or adjusting the signal voltage to the specific voltage level ( $V_b' = V_a + (3 V_b / 4) V$ ).

### 3. CP1223 Development Kits

An optical wireless communications development kit consists of two parts, namely the hardware and the software. In the hardware design, the ease of use and cost of building or development work has been taken into account. The ease of use has made the selection of Arduino microcontroller, in order to start the development of optical communication products quickly and easily.

The selected Arduino microcontroller model to use in this design is Arduino Pro micro (mini Leonardo), which is popular among developers and it is small and affordable. This Arduino Pro micro is used to control the operation of electronic hardware. In the software or programming part, the structure of the program is made clear and easy to edit. Moreover, we are also preparing all source codes so as to demonstrate a large number of applications.

#### 3.1 Specifications

Optical wireless communications devices have been developed in accordance with the CP1223 standard to control the LED emitting visible light along with signal transmission. At the receiver, the received light is converted back to an electrical signal using a photo diode. The hardware features of the development kits are shown below.

- Arduino Pro micro (mini Leonardo) 2 boards
- Interface boards 2 boards
- 16 MHz clock frequency
- Input voltage 5 V (if the RAW pin, can be 6 - 20 V)
- current output = 50 mA
- 2 × PWM output port, 4 × analog and 3 × digital input ports, 1 × I<sup>2</sup>C and 1 × SPI port
- Software Arduino bootloader

- LED High Brightness 1W,  $I_f = 350$  mA,  $V_f = 3.4$  V, Luminous Intensity = 100 lm
- Silicon PIN Photodiode SFH213,  $V_R = 5$  V, Responsivity = 0.65 A/W, Wavelength range 400 - 1100 nm,  $t_r = t_f = 5$  ns, sensitivity area = 1 mm<sup>2</sup>.

#### 3.2 System Overview

The wireless optical development kits consist of a wireless transmitter and receiver kits as shown in Figure 4. Both devices have the same hardware that can be configured to be a transmitter or a receiver module. The processing equipment and a controlling device use the Arduino Pro micro microcontroller that has to be programmed differently. For the transmitter board, the information signal, which is generated from the microcontroller, is fed to transmitting circuit that is connected to the LED light source device. The information is transmitted via the illumination of the emitted light.

At the receiver, the signal is retrieved by using a photo diode with an amplifier and then passes through the microcontroller, which is programmed to decode the transmitted sequences. The operation of the control system for this wireless optical communication can be done by microcontroller software programming through a computer via an interface board.

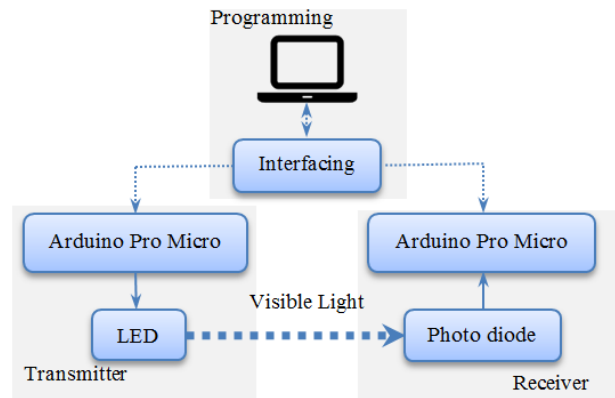

Figure 4. System overview

#### 3.3 Details of the development board

A development board equipped with a main board, a microcontroller Arduino Pro micro (mini Leonardo), and the extensions that are supported input and output as shown in Figure 5. The block diagram of the development board is also shown in Figure 6.

For transmitting light signal, the signal from a microcontroller is sent to control the illumination of the LED lamp via the LED driver circuit on the development board. On the other hand, the reception of visible light signal is passed to the microcontroller on the development board via the photo diode and the light receiver circuit. After the signal is received, the microcontroller will calculate and retrieve the transmitted signal back.

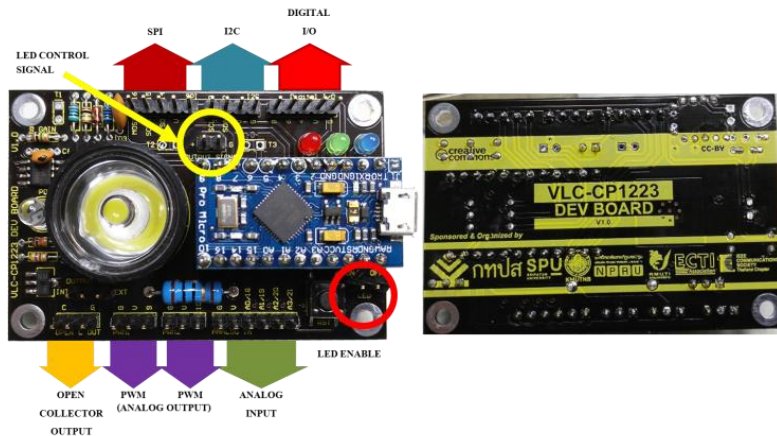

Figure 5. Development board (front - back)

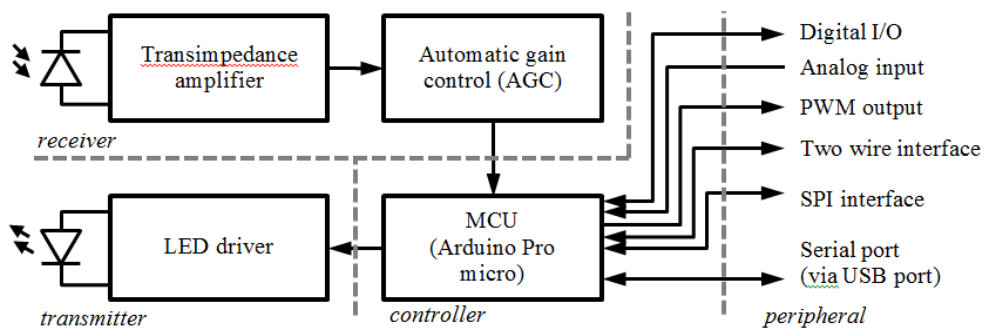

Figure 6. Block diagram of the development board

### 3.4 Details of the Microcontroller Programming

To control the microcontroller Arduino Pro micro (mini Leonardo), the Arduino IDE program is used. This Arduino IDE program is an open source that is developed for programming and uploads the program sketch to the microcontroller device. The Arduino IDE can be downloaded at <https://www.arduino.cc/en/Main/Software>.

The microcontroller programs are developed by the two major parts, namely the main program and the function library. Generally, the main program is used to control the development board, including commands to control variables, registers and ports, and command sequence control functions to control the program procedure. Moreover, the program that controls the basic level, which is called the function library, VLC\_CP1223\_QSC.h, is written separately from the main program and will be run when needed. This function library is written to declare addressing, the list of critical functions, constants and variables of the transmitter and the receiver.

### 3.5 Usage Examples

Examples of the microcontroller programs on both the transmitter and the receiver side are written in order to send and receive data over the visible light according to the CP1223 standard. The examples of programs are developed to show, in details, the separate development of the transmitting and receiving program scripts that are listed in the Figure 7 and Figure 8 respectively.

```

/*
  Example Transmit VLC-CP1223 DATA
  Credit:
  This work used the VLC-CP1223 driver-code VLC_CP1223_QSC.h
  "VLC-CP1223 QUICK STARTER CODE", Kata Jaruwongrungrsee, CC-BY
  Which is licensed under a Creative Commons Attribution 4.0
  International License.
  To view a copy of this license, visit
  http://creativecommons.org/licenses/by/4.0/
  */

#include "VLC_CP1223_QSC.h" //Add this file & include it first
void setup()
  startVLC_OUT(5); //SET VLC_out PIN (default = 5)
                //PWM PIN IS NEEDED (3,5,6,9,10 for Leonardo)
  char data[] = {(char)0x1b, (char)0x1b, (char)0x1b, (char)0x1b,
                (char)0x1b, (char)0x1b, (char)0x1b, (char)0x1b,
                (char)0x1b, (char)0x1b, (char)0x1b, (char)0x1b,
                (char)0x1b, (char)0x1b, (char)0x1b, (char)0x1b};
  setupMessage((char) 0, data); //SET MESSAGE TO SEND
//--->> FUNCTION: setupMessage(FTYPE(1 byte), DATA(max 16 byte))
}
void loop()
{
//--->> TRANSMIT DATA - FUNCTION: transmitALL();
  transmitALL();
}

```

Figure 7. Transmitting program scripts

## 4. Experimental Results

The transmitting and receiving signals of the development modules that are configured to be the transmitter and receiver are shown in Figure 9. The transmitted signal is in the upper trace and the received signal is in the lower trace of the oscilloscope. The details of the transmitted signal are shown in Figure 10, which are in the I-4PPM format with 6-bits PRE, FTYPE = 00h (00h = 0000 0000b and I-4PPM = 1000 1000 1000 1000), Data = 1B1B1B1B1B1B1Bh (1Bh = 0001 1011b and I-4PPM = 1000 0100 0010 0001)

```

/*
Example 2 Show Received VLC DATA(CP1223) on Serial Port
Show Received VLC DATA on Serial Port
Credit:
This work used the VLC-CP1223 driver-code VLC_CP1223_QSC.h
"VLC-CP1223 QUICK STARTER CODE", Kata Jaruwongrunsee, CC-BY
Which is licensed under a Creative Commons Attribution 4.0
International License.
To view a copy of this license, visit
http://creativecommons.org/licenses/by/4.0/
*/
#include "VLC_CP1223_QSC.h" //Add this file & include it first
void setup()
{
  startVLC_IN(7); //SET VLC_IN PIN (default 7);
  Serial.begin(9600);
}
void loop()
{
  //Main Function is "VLCread()"
  //which return 1(integer) when data is correct
  //and return 0(integer) when no data detected
  //IF DATA IS DETECTED PAYLOAD_IN[0-17] (byte) will be updated
  //PAYLOAD_IN[0] = FTYPE, ID
  //PAYLOAD_IN[1-17] = MESSAGE
  if (VLCread()==1) //<<---- VLC Signal Detecting
  {
    printMESSAGE_IN(); //Print Message (ID+Message);
  }
}

```

Figure 8. Receiving program scripts

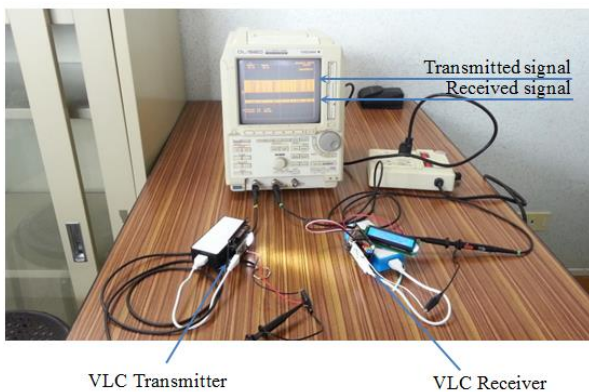

Figure 9. Experiment in the transmitting and receiving

and 16-bits CRC. From the measurement, the optical clock pulse is exactly 104  $\mu$ s, which can perform 4.8 kbps data transmission with less than 0.5% tolerance of data rate. In addition, the transmitted frame period of 158-bits length is 32.864 ms. In the receiver side, the received signal is obtained from the silicon PIN photodiode SFH213 and passed through the amplifier to the microcontroller and then the information is recovered.

### 5. Conclusion

The VLC wireless optical communications development kit compliant to the CP1223 standard composes of hardware and software. The hardware is developed from the Arduino Pro micro (mini Leonardo) microcontroller, which is small, inexpensive, widely used, and easy to get started. The microcontroller is used to control the driver and receiver circuit of the LED light source and the photo diode.

On the other hand, the software scripts are programmed into the microcontroller to create and control the I-4PPM modulation and the serial data formatting according to the CP1223 standards defined. The development kit will be able to reduce the time to develop the VLC products with the ease of use and low complexity.

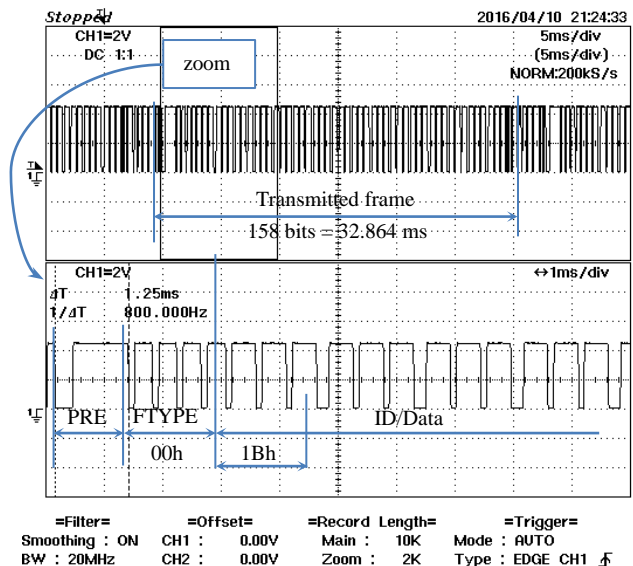

Figure 10. The transmitted signal waveform

### Acknowledgements

This work is partly supported by NBTC grants T3-001/1-57 under the project entitled “Visible Light communications for Thailand: Technology Transfer, Human Resource Development, Industrial Standard Survey, and Its Publications.”

### References

- [1] JEITA, JEITA visible light communication standards, URL: [http://www.jeita.or.jp/cgi-bin/standard\\_e/list.cgi?ateid=1&subcateid=50](http://www.jeita.or.jp/cgi-bin/standard_e/list.cgi?ateid=1&subcateid=50). [Accessed 26/6/2015]
- [2] IEEE Computer Society, IEEE Standard for Local and metropolitan area networks—Part 15.7: Short-Range Wireless Optical Communication Using Visible Light (IEEE Std 802.15.7TM-2011), New York, The Institute of Electrical and Electronics Engineers Inc., 2011.