

# Voltage Beam-Steerable Leaky-wave Antenna Using Magnet-less Non-Reciprocal Metamaterial (MNM)

Yuhi Yokohama\*, Toshiro Kodera\*

\*Department of Interdisciplinary Science and Engineering, Meisei University, Tokyo, 1918506, Japan  
Email: 12t3043@stu.meisei-u.ac.jp

**Abstract**—A novel voltage beam-scanning leaky-wave antenna, consisting of an array of traveling-wave resonant particle by metal ring resonator with variable capacitance and uni-lateral component is proposed, analyzed, and measured. In contrast to ferrite-based leaky-wave antenna, this antenna does not require a biasing magnet but only an bias voltage for the FETs, and beam steering voltage for varactor diodes. The simulation result exhibits clear full-space beam scanning at 7 GHz, and its properties are examined by prototype antenna structure.

**Index Terms**—Artificial magnetic gyrotropy, non-reciprocity, magnet-less magnetic metamaterial (MNM), leaky-wave antenna, beam-steerable.

## I. INTRODUCTION

Magnetic materials such as rare-earth iron-oxide known as ferrite exhibits magnetic gyrotropy and frequency tunability by biasing magnetic field variation[1]. These useful properties has played ubiquitous key roles in microwave engineering to realize non-reciprocal component including circulators, isolators, nevertheless they suffers from drawbacks such as requirement of magnetic biasing and low compatibility to integrated circuit technology. Recently, the authors have presented Magnet-less Non-reciprocal Metamaterial (MNM) as a counterpart to biased ferrite[2], [3], [4]. MNM is an artificial electromagnetic material technology emulating magnetic gyrotropic properties, and various non-reciprocal microwave devices can be realized in the same manner of ferrite[4], [5]. In this paper, voltage beam-steerable leaky-wave antenna using tunable MNM consisting of traveling-wave resonator with varactor diode is proposed.

## II. PRINCIPLE OF OPERATION

Fig. 1 illustrates the fundamental principle of MNM, starting from precession of the magnetic dipole moment in biased magnetic material governed by the Landau-Lifshitz's equation. The precession of magnetic dipole moment produces magnetic gyrotropy, expressed by Polder tensor permeability, leading to non-reciprocal response in electromagnetic structures. The fundamental structure of MNM is shown in right of Fig. 1(a), consisting of metal ring resonator with one uni-lateral component (isolator) on metal backed dielectric substrate. In the case of isolator absence, this particle forms standing-wave resonance for wave irradiation, but insertion of isolator turns into traveling wave resonance satisfying one turn phase matching condition ( $2n\pi$ ) corresponding to the accumulated phase shift in metal ring and isolator. Fig. 1(b) showing electric and magnetic fields at different instants during one harmonic period, showing its rotating magnetic field in ring

resonator. From macroscopic viewpoint, the excited magnetic field is equivalent to magnetization, therefore this particle produces rotating magnetic dipole moment during harmonic period exactly same as biased ferrite materials[3]. The created motion of magnetic dipole moment is governed by resonance distributed line structure of the particle, and hence variation of electrical length of resonator gives operation frequency variation. In this paper, voltage tunable MNM consisting of varactor diode inserted resonance particle is applied to MNM based leaky-wave antenna enabling voltage beam scanning.

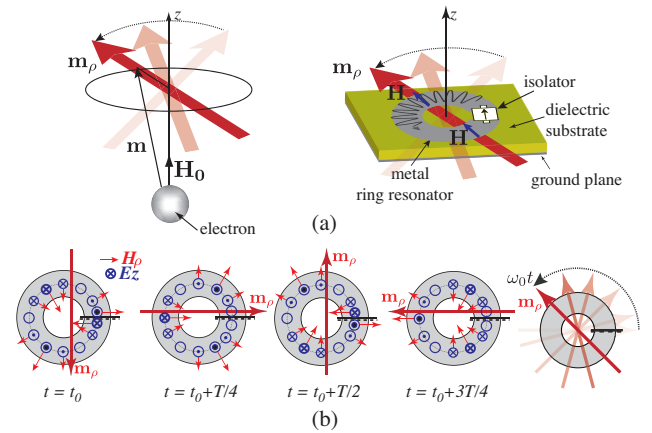

Fig. 1. Principle of Magnet-less non-reciprocal metamaterial (MNM) and related artificial magnetic gyrotropy. (a) Comparison of MNM unit cell, consisting of metal ring resonator and one uni-lateral component and precession of the magnetic dipole moment in a biased ferrite material. (b) Electric and magnetic fields at different instants during one harmonic period, showing its rotating magnetic dipole in ring resonator.

Fig. 2 shows the proposed MNM based voltage-steerable leaky-wave antenna structure, where the tuning property is implemented through variable phase shift generated by varactor diode. The bias voltages for varactor diodes (MA46H070) and FETs (NE3210S01) are feed through meander lines and chip inductors (19nH). All the bias lines are grounded in RF level by additional capacitors (1pF and 1 $\mu$ F). Ohmic resistors (100 $\Omega$  and 68 $\Omega$ ) are inserted for impedance matching between FET and ring resonator. Ohmic matching is not ideal in view point of power consumption, but these are employed due to footprint limitation within resonant particle. The impedance matching between ring resonator and FET is crucial since it enhances the traveling-wave resonance required for magnetic gyrotropy. As shown in [5], in the absence of varactors the rings resonate

when

$$r = \frac{9c}{4\pi f_0} \frac{1}{2\sqrt{\varepsilon_r} + \sqrt{\varepsilon_e}}, \quad (1)$$

where  $r$  is the mean radius of the rings,  $f_0$  is the resonance frequency,  $c$  is the speed of light in vacuum,  $\varepsilon_r$  (here  $\varepsilon_r = 3.27$  is the permittivity of the substrate, and  $\varepsilon_e$  is the effective permeability of the microstrip line building the rings. From (1), a radius of  $r = 5.85$  mm is obtained for operation at  $f_0 = 7.0$  GHz.

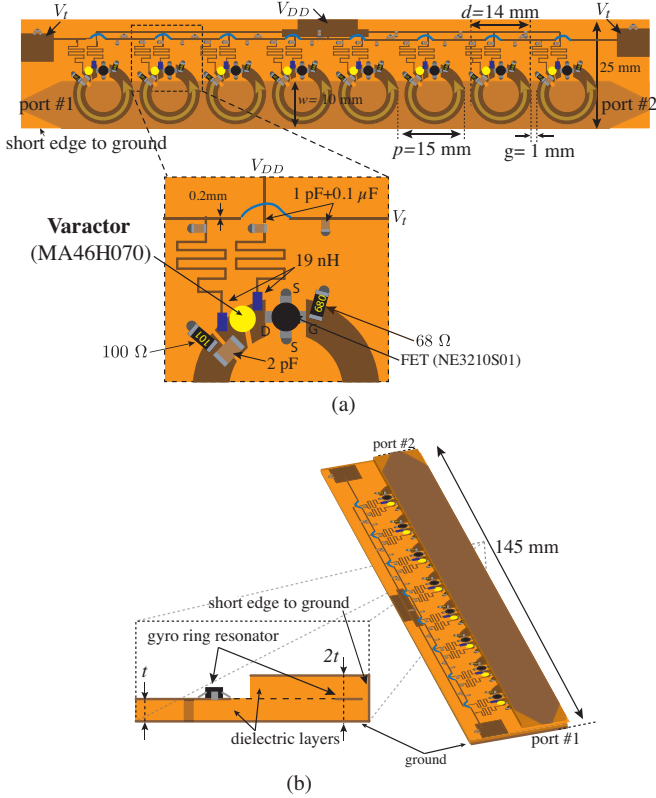

Fig. 2. Proposed MNM based voltage-steerable leaky-wave antenna with varactor diodes in series to FETs. (a) Top view with dimensions. (b) Perspective view.

### III. SIMULATION RESULTS

Fig. 3 shows the simulation model for the leaky-wave antenna in *CST Microwave Studio* utilising its co-simulation capability. All dimension and connection are corresponding to those in Fig. 2. Electromagnetic model has outer ports (port # 1 and # 2) and local ports for isolator model connection. The port # 3 is prepared above antenna structure for simulations of normal incidence to the antenna. These local ports are connected to ideal  $\pi$ -phase shift isolator in series with variable capacitance  $C_t$  for frequency tuning. This capacitance value are determined within the feasible value by actual varactor diode (MA46H070).

Fig. 4 shows the simulated radiation patterns of the antenna model of Fig. 3. Fig. 4(a) shows radiation patterns examined in  $\phi = 0$  plane for tuning capacitance of  $C_t = 0.6, 1.0, 1.8$

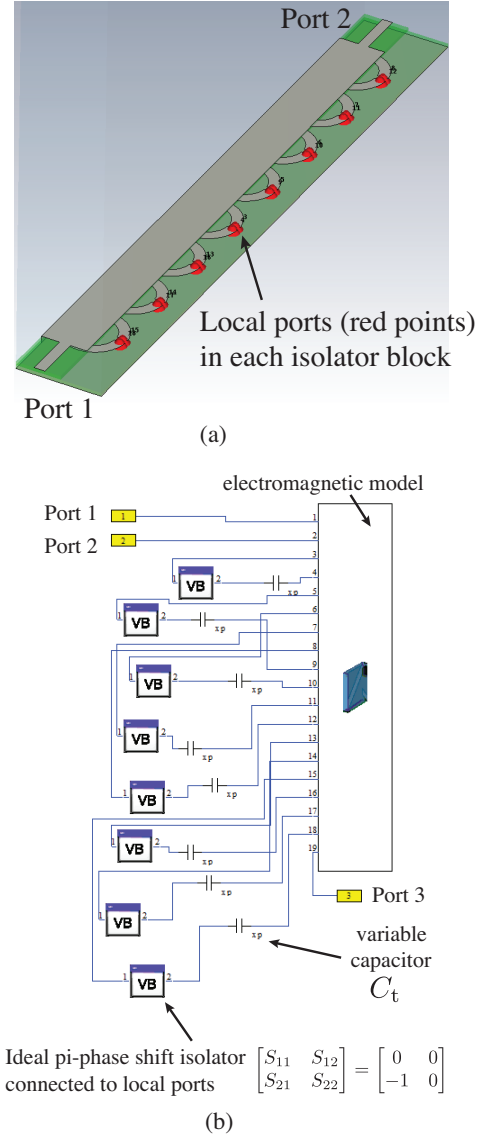

Fig. 3. Simulation model for the leaky-wave antenna in *CST Microwave Studio*. (a) Electromagnetic model with ports definitions. (b) Circuit model. Ports 3 to 10 are connected to ideal isolators (modeling FETs) with  $\pi$ -phase shift through variable capacitors  $C_t$  for frequency tuning.

pF for a fixed frequency of 7.15 GHz. In the same manner as frequency beam scanning in [5], clear full-space beam scanning is obtained. In order to show  $\theta$ -plane radiation pattern, 3D radiation pattern for  $C_t = 1.0$  pF is presented in Fig. 4, which is showing clear fan-beam to normal direction.

### IV. MEASUREMENT RESULTS

Fig. 5 shows the voltage beam-steerable leaky-wave antenna prototype, while Fig. 6 plots the corresponding measured radiation patterns. The bias voltage for varactors  $V_t$  varies from 7.5 to 14.5 V.

Compared to the simulation results in Fig. 4, scanning range from  $-30^\circ$  to  $45^\circ$  is comparable but with relatively

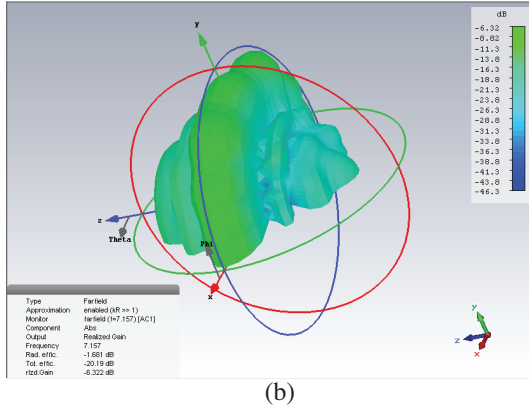
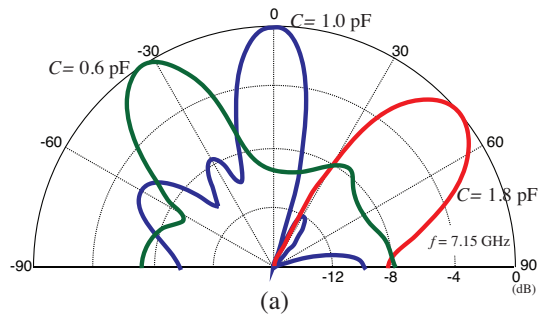

Fig. 4. Simulated radiation patterns of the antenna of Fig. 3. (a) Radiation pattern for  $\phi = 0$  plane for  $C_t = 0.6, 1.0, 1.8$  pF. (b) 3D radiation pattern for  $C_t = 1.0$  pF, showing fan-beam for normal radiation. The capacitance  $C_t$  is varied over the available values by the varactor (MA46H070).

high side-lobe level. In the measurement, side-lobe beam pattern is stable for varactor tuning, therefore these side-lobe can be attributed to the radiation outside leaky-wave waveguide structure including feeding part connecting SMA to waveguide, DC biasing network. These spurious radiation can be avoided by using proper EM absorber. The imperfect fabrication process also gives inferior beam pattern to the simulation result. The difference of the operation frequency (simulation: 7.15 GHz, measurement: 7.3 GHz) is due to non- $\pi$  phase shift in actual FET block and precise de-embedding of FET block provides more accurate characterization. Now shown in this manuscript but frequency beam scanning is also confirmed as same as the antenna in [5].

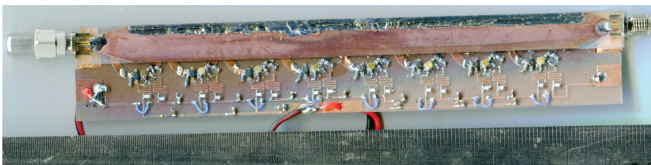

Fig. 5. Voltage beam-steerable LWA corresponding to Fig. 2.

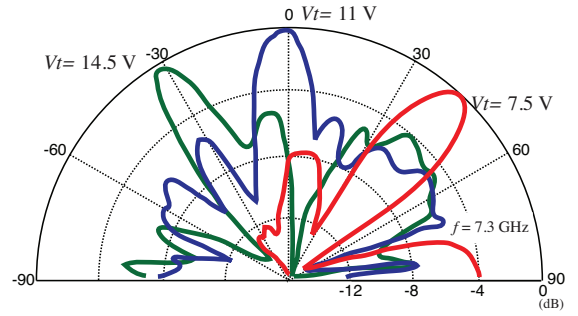

Fig. 6. Measured radiation patterns of the LWA of Fig. 5 for  $V_t = 7.5, 11, 14.5$  V. (Values are normalized)

## V. CONCLUSION

A MNM based voltage beam-steerable leaky-wave antenna had been proposed and demonstrated. The simulation results show its perfect full-space scanning property, and its prototype antenna structure gives corresponding beam patterns.

## ACKNOWLEDGEMENT

This work has been carried out under the sponsorship of KAKENHI Grant-in-Aid for Research Activity # 26289106.

## REFERENCES

- [1] B. Lax and K. J. Button, *Microwave Ferrites and Ferrimagnetics*, McGraw-Hill, 1962.
- [2] T. Kodera, D. L. Sounas, and C. Caloz, "Artificial Faraday rotation using a ring metamaterial structure without static magnetic field," *Appl. Phys. Lett.*, vol. 99, pp. 031114:1-3, July 2011.
- [3] D. L. Sounas, T. Kodera, and C. Caloz, "Electromagnetic Modeling of a Magnetless Nonreciprocal Gyrotropic Metasurface," *IEEE Trans. AP*, Vol. 61, No. 1, pp. 221-231, Jan. 2013.
- [4] T. Kodera, D. L. Sounas, and C. Caloz, "Magnetless Nonreciprocal Metamaterial (MNM) Technology: Application to Microwave Components", *IEEE Trans. MTT*, Vol. 61, No. 3, pp. 1030-1042, Mar 2013.
- [5] T. Kodera, D. Sounas and C. Caloz, "Non-reciprocal magnet-less CRLH leaky-wave antenna based on a ring metamaterial structure," *IEEE Antennas Wireless Propagat. letters*, vol. 10, pp. 1551-1554, Jan. 2012.