

# The Performance Enhancement of UHF RFID Reader in Multi-path Fading Environment Using Antenna Diversity

Chang Seok Yoon<sup>1</sup>, Ki Yong Jeon<sup>2</sup>, Sung Ho Cho<sup>3</sup>

<sup>1,3</sup> Graduate School of information and communication, Hanyang University  
17 Haengdang-Dong, Sungdong-Gu, Seoul, 133-791, Korea

<sup>2</sup> Semiconductor Material R&D Center, Samsung Techwin Co., LTD

145-3, Sangdaewonl-dong, Seongnam-si, Gyeonggi-do, 462-703, Korea

E-mail: <sup>1,3</sup>{csyoon, shcho}@casp.hanyang.ac.kr, <sup>2</sup>kiyong.jeon@samsung.com

**Abstract:** In wireless communication, the multi-path fading effect has big influence on the system performance. Especially, in passive UHF RFID system where tag is operated by the power supplied with the RF signal of the reader, the influence of multi-path fading increases. Therefore the communication performance changes drastically depending on the locations of tags and reader. In this paper, we propose a method to improve the performance of identification area and identification stability by using the antenna diversity. It decreases the shadow area and the bit error rate (BER) in situation of uniformly distributed tags.

## 1. Introduction

The RFID is an efficient technology for identifying the objects in close range substituting the conventional auto ID systems. Especially, the UHF RFID system provides relatively long identification range by using higher frequency of radio wave [1, 2] and low cost system which decreases the tag price[3]. Therefore the UHF RFID system is expected to be the next generation auto ID system. On the other hand, in UHF RFID system there are many technical problems to solve. Firstly, the electronic microwave which UHF RFID system uses is very sensitive comparing with the lower frequency signals. Secondly, the tags which have no embedded power are activated by power radiated from the reader. So the cost of tags is remarkably decreased without the implementation requirement of power. The performance of power transmission decides the system performance because the tags only need a minimum receiving power to operate normally. Especially in multi-path fading environment, the transmission performance changes considerably according to the position of the tag. Therefore the method to enhance the transmission efficiency is essential to achieve superior identification performance. There are some solutions for decreasing the multi-path fading effect. Some antenna companies make narrow emission angle of transmission antenna[4]. Though this method can decrease the multi-path fading effect in the identification area, it also has defects to make identification area smaller comparing with conventional one. In this paper, we present a new method for enhancing the transmission performance by using antenna diversity. This method can effectively decrease the multi-path fading effect in the identification area and widen the identification area by controlling the antenna beam pattern. And in the receiving parts, the same antenna diversity is also used to improve the bit error rate

and decrease the power extravagance. The method proposed requests little changes to hardware structure but shows obvious efficiency improvement in power transmission and total system performance.

## 2. Conventional Antenna Diversity Scheme Analysis

When the radio wave collides with the obstacles, it reflects to some other direction and makes another path. In the receiver position, the signals with different phase combine to a distorted signal, the phenomenon of which is called as multi-path fading. For the narrow band short range system like UHF RFID system, the carrier wave phase differences of each signal path make the received signal power up and down. When the signal power is extremely lowered to below the limit of receiver then it makes communication shadow area. For the passive UHF RFID system, tag can operate over the -9dBm signal power. Therefore the position at which the signal power gets below -9dBm from the reader is the shadow area of the UHF RFID system.

There are many modeling methods for multi-path fading environment. For the short range communication environment, the ray tracing method is proper for evaluating the wireless channel[5]. The ray tracing method considers every transmitted signal reflection path in the receiver position and accumulates the received signal. In this paper, we only consider the 1 reflection path because other reflection paths are small enough to be ignored

We assume the environment where there is not much multi-path fading effect depicted in Fig 1. The experimental area is a small room with 6m width and 10 m length. The reader is located on the wall of center as described in fig 1.

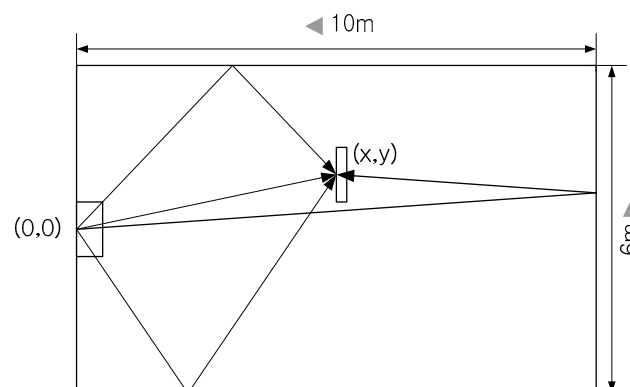

Fig. 1 Defined experimental environment

And we model the real directional antenna which has  $\frac{\pi}{3}$  emission angle, 9dBi center antenna gain and 6dBi antenna gain on  $\pm\frac{\pi}{6}$  angle position as equation 1. The graphs of equation 1 are described in Fig.2.

$$G_{ix}(\text{dBi})=27\cos(\theta/2)^4-18 \quad (1)$$

And reader transmission power is 30dBm and tag has 2.15dBi gain omni-directional antenna. Then the received signal of each position is represented as

$$P_r(\text{dBm})=10*\log\left[\left(\sum_{k=1}^n a_k \cos w_k\right)^2 + \left(\sum_{k=1}^n a_k \sin w_k\right)^2\right]+30 \quad (2)$$

Where  $a_k, w_k$  are the each path gain and the phase difference of  $k^{\text{th}}$  signal are represented as,

$$a_k(\text{dB})=30+G_{Tx}+2.15+10\log_{10}\frac{\lambda^2}{(4\pi d)^2} \quad (3)$$

$$w_k=d/\lambda \times 2\pi$$

,where  $d$  is the propagation distance and  $\lambda$  is the transmitted signal frequency. Using equation (2), (3), the power transmission is obtained as Fig. 3. The shadow area is calculated as 3.11 %. The rate dramatically increases when the multi-path fading effect is severe.

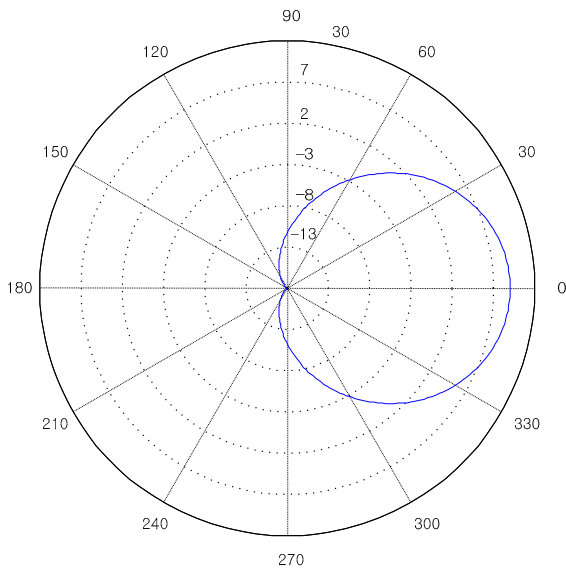

Fig. 2 Reader antenna power model

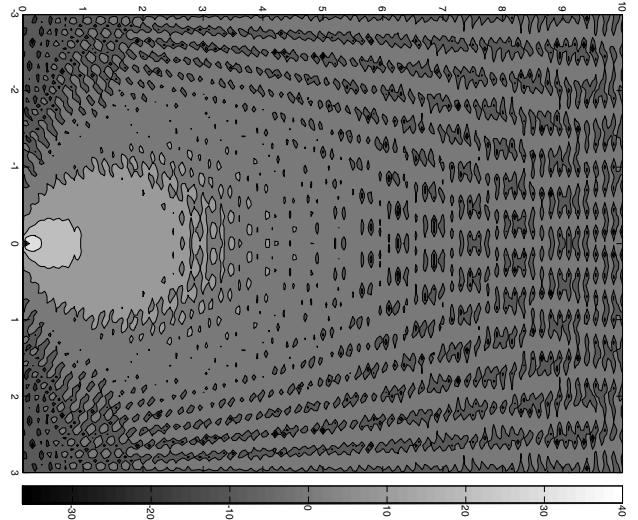

Fig. 3 Reader transmitting power in multi-path environment

### 3. Dual Antenna Diversity Scheme

For decreasing the power attenuation caused by multi-path fading effect, the reader antenna beam pattern has to be sharpened to compare with the conventional one. But the sharpened antenna pattern makes identification area decreased. Therefore we introduce an additional antenna to

obtain controllable sharp beam pattern. By using phase difference of each antenna, the antenna can get 4 sharp antenna beam patterns. Therefore it decreases the multi-path fading effect and also increases the identification area. The proposed dual antenna system is described in Fig 4.

The distance between each antenna is  $\frac{\lambda}{2}$  [6], the power of each antenna is half of the conventional one and the phase difference can be achieved as  $\pi, +\frac{\pi}{2}, -\frac{\pi}{2}$  basing on the conventional reader system which contains the SSB modulator. As a result, the power transmission efficiency of the reader for all the area increases.

In addition, the dual antenna scheme makes the receiver part more reliable by using diversity[7]. In UHF RFID reader the zero-conversion mixer is used in the receiver part. The zero-conversion mixer can't compensate the phase error of the received signal. This phase error makes receiving performance degraded. In dual antenna scheme, the receiving path can be doubled. As a result it gives the chance to get signal with smaller phase error. The dual antenna diversity scheme in receiver is described in Fig 5. And the received signal of each channel is represented in equation (4).

$$\begin{aligned} S_{1I} &= a_1 \rho \cos(w_1 + j) \\ S_{1Q} &= a_1 \rho \sin(w_1 + j) \\ S_{2I} &= a_2 \rho \cos(w_2 + j) \\ S_{2Q} &= a_2 \rho \sin(w_2 + j) \end{aligned} \quad (4)$$

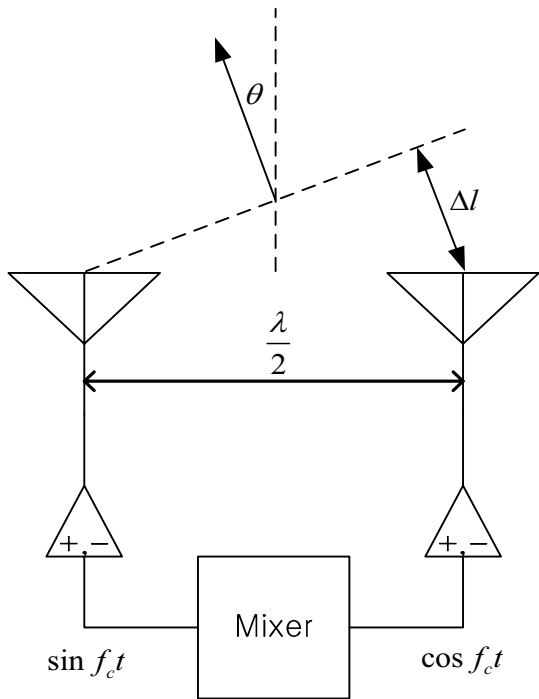

Fig. 3 Dual antenna transmitter scheme

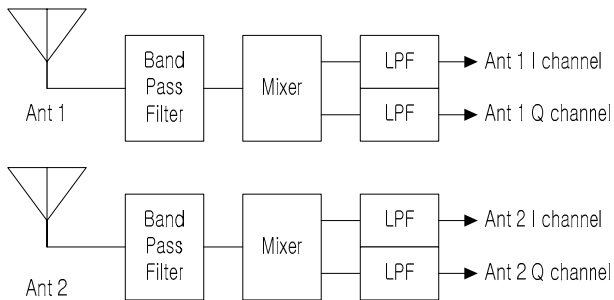

Fig. 4 Dual antenna diversity scheme in receiver

#### 4. Simulation Result

Based on the previous assumption, the performance evaluation simulations are performed in two territories. The first evaluation is the reader to tag power transmission efficiency to calculate the proportion of the shadow area. The second evaluation is the tag to reader signal transmission error rate in case of uniformly distributed tags.

The simulation environment is the same as described in Section 2. And every beam patterns made by phase differences between antennas are included. In the first evaluation for the dual antenna diversity scheme reader, the shadow area rate is 0.2 % portion. Comparing with the conventional antenna scheme, the shadow area rate is dramatically decreased.

In the second evaluation for the error rate in the additive white Gaussian noise environment, the error rate of dual antenna diversity scheme reader is 10 times better than in -70dbm noise level which depict in Fig. 8[8].

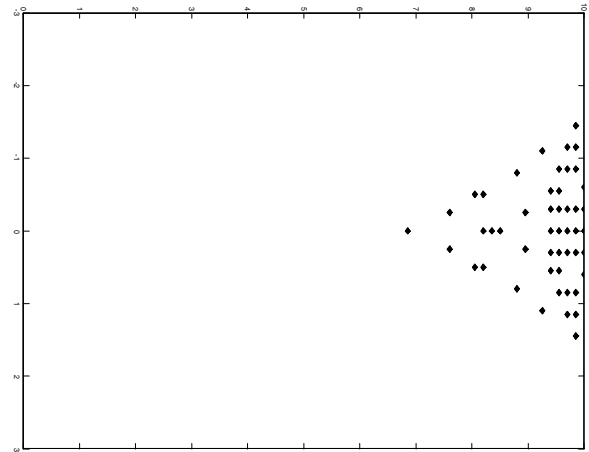

Fig. 6 The shadow area of dual antenna UHF RFID reader



Fig. 7 shadow area of conventional single antenna system

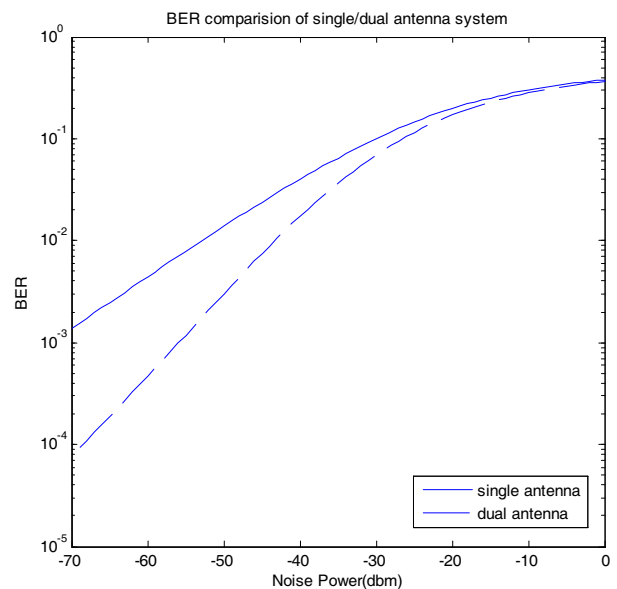

Fig. 8 The shadow area of dual antenna UHF RFID reader

## 5. Conclusion

In order to be accepted as the next generation AutoID system, the UHF RFID system requires the technology for identifying multi-tags correctly in short range area. But in case of conventional reader using single antenna scheme, there are big potential to appear the problem caused by multi-path fading effect depending on identification environment. For solving this problem, in this paper we present dual antenna diversity UHF RFID system. Dual antenna diversity system make beam pattern narrower that extremely decrease the multi-path fading effect and efficiently remove shadow area of identification. As a result it improves the reader to tag power transmission efficiently. And also easily controllable beam pattern makes identification area widen. Additionally in receiver part, increased receiver diversity make identification rate increased. For the future work, we'll implement this scheme to real UHF RFID reader and evaluate practical performance enhancement of it.

## 6. Acknowledgement

The work was supported by HY-SDR Research Center at Hanyang University, Seoul, Korea, under the ITRC program of Ministry of Knowledge Economy, Korea.

## REFERENCES

- [1] J. G. Proakis, *Digital communications*, 4th ed. Boston: McGraw-Hill, 2001.
- [2] B. Sklar, *Digital Communications*, 2 ed.: Prentice Hall PTR, 2000.
- [3] K. Finkenzeller, *RFID handbook : fundamentals and applications in contactless smart cards and identification*, 2nd ed. Chichester, England ; New York: Wiley, 2003.
- [4] T. Nakamura and J. Seddon, "OMRON Develops World's First Antenna Technology That Boosts UHF RFID Tag Read Performance ", 2006.
- [5] J. C. Lee, H. G. Yang, J. H. Kim, and J. Y. Kim, "Design of wired/wireless Communication System," *Intervision*, 2007.
- [6] T. Haynes, "A Primer on Digital Beamforming," *Spectrum Signal Processing*, March 26, 1998.
- [7] D. H. Lee, K. Y. Jeon, and S. H. Cho, "Performance analysis of the modified I/Q channel demodulation in UHF RFID system," in *HUT\_ICCE2006* Hanoi, Vietnam, 2006.
- [8] A. Papoulis and S. U. Pillai, *Probability, random variables, and stochastic processes*, 4th ed. Boston: McGraw-Hill, 2002.