



### 3. Decoder Structure in DVB-S2 Standard

We can divide calculation into 3 steps. Step 1 is initialization that calculates channel estimation value with received bits, Step 2 is CNU that calculates Check Node, Step 3 is BNU that calculates Bit Node Update.

Step 1. Initialization as shown in Fig. 2(a) and using Eq(2).

$$u_n = -L_c \cdot r_n \left( L_c = \frac{2}{\sigma^2} \right), \quad n = 0, 1, \dots, N-1, \quad (2)$$

Step 2. Check Node Update (CNU)

Fig. 2(b) shows that it is calculated probability of the incoming messages to one check node. If it has dc row weight, bits' probability incoming to each check node is as same as Eq(3).

$$w_{k \rightarrow n_1} = g(v_{n_1 \rightarrow k}, v_{n_2 \rightarrow k}, \dots, v_{n_{dc} \rightarrow k}) \quad (3)$$

$$g(a, b) = \text{sign}(a) \times \text{sign}(b) \times \{ \min(|a|, |b|) \} + LUT_g(a, b)$$

$$= \text{sign}(a) \times \text{sign}(b) \times \{ \min(|a|, |b|) - LUT(|a-b|) \}$$

$$LUT(|a-b|) = \begin{cases} 2 & |a-b| \leq 2 \\ 1 & 3 \leq |a-b| \leq 6 \\ 0 & |a-b| \geq 7 \end{cases}$$

It shows  $LUT_g(a, b) = \log(1 + e^{-|a+b|}) - \log(1 + e^{-|a-b|})$

Step 3. Bit Node Update (BNU)

After each check node has been updated using dv bits which are connected to check node, we must calculate bit node's probability proper for each column.

$$v_{n \rightarrow k_i} = u_n + \sum_{j \neq i} w_{k_j \rightarrow n} \quad (4)$$

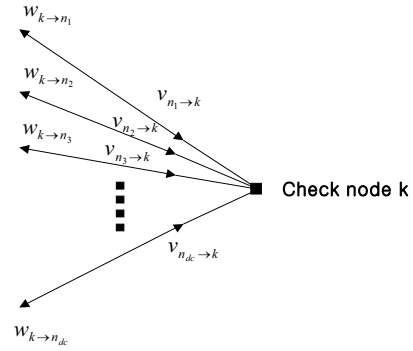
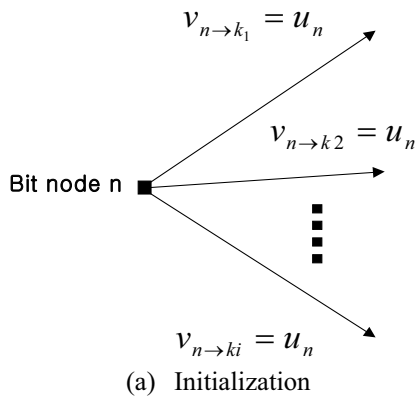

(b) BNU

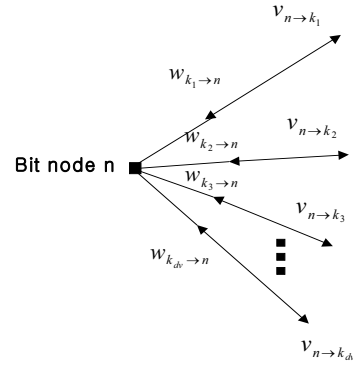

(c) CNU

Figure 2. LDPC decoding procedure

### 4. Partial Parallel Algorithm for LDPC Decoder

In this section, we propose a decoder design scheme to construct the rate - 1/2 LDPC codes. The decoder implementation is classified into largely using the FPGA board or the ASIC. Such fully parallel decoder could achieve tremendous high decoding speed. However, the primary disadvantage of fully parallel design leads to increasing not only the code length but also high implementation complexity causing the excess in the capacity of a chip. Therefore, we can know that the partial parallel scheme is the efficient selection to achieve appropriate trade-offs between hardware complexity and decoding speed. Fig. 3 illustrates the entire block diagram for designing the decoder on the FPGA.

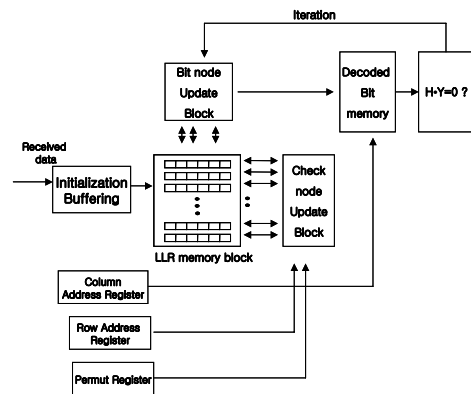

Figure 3. LDPC decoder structure

The partially parallel decoder consists of entirely the assigned block that multiplied received data by channel transmit probability in memory and the CNU (Check Node Update) block and the BNU (Bit Node Update) block. LLR memory structure that is equivalent to the column address proposed by HNS [1] in DVB-S2 comprises the total 90 blocks in which each block has 360 data as shown in Fig. 4.

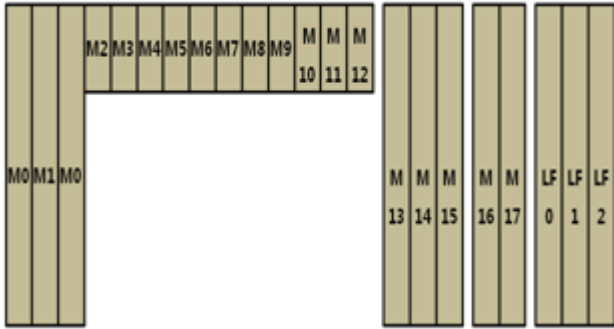

Figure 4. LLR memory structure

To facilitate CNU processing, the Rom\_Index denotes whether what memories, among vertical 90 blocks, have same column address to calculate CNU. At the memories, Address\_Index directs what block has same column address. And Permut\_Index informs the point where block is started to read. Fig. 5 shows the inner block structure that LLR memory structure in Fig. 5 enlarges.

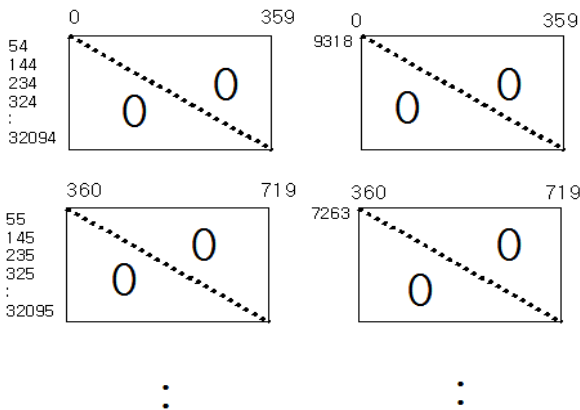

Figure 5. Inner block structure

### 5. The partially parallel structure

We store row block in different memory in principle. The column block saves the same memory which the number is equivalent to the total 'eight' like the number of Column weight in LDPC codes ( $N=64800, \text{rate}=1/2$ ). The number of entire data using one of the memories is composed to  $32400 \times 6$  bits. Saving 144 bits at one address, we require 1350 addresses. As the memory of chip implemented is able to process  $144 \text{ bits} \times 4\text{K}$ . In the CNU mode, decoder performs the computation of all the check nodes. Calculating the CNU is able to access 8 memories in parallel. The Decoder

scheme is denoted in detail in Fig. 6 from memory access point of view given in Fig. 4.

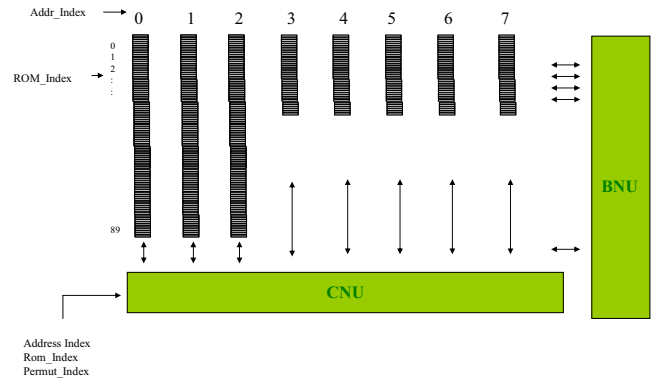

Figure 6. Decoder structure for implementation of partial parallel

Address Index block is divided into 90 blocks that save 360 data. Consequently 90 memory blocks can save the total of 32400 received data. This method is able to store easily the initialization and buffering block. As Fig. 7, describes the scheme calculating the BNU, we need to know the Address\_Index, the Rom\_Index and the Permut\_Index to process the scheme of the CNU.

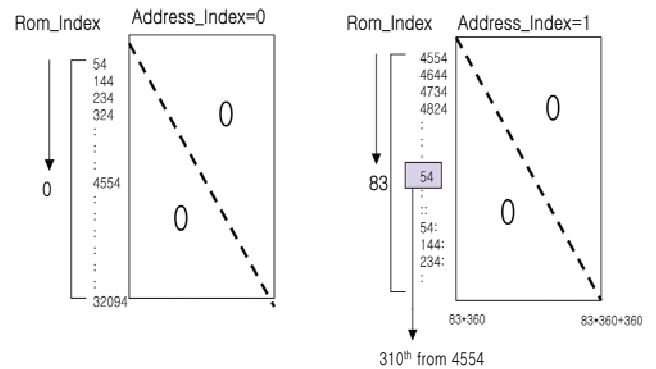

Figure 7. Example (CNU excess)

Both the CNU and the BNU block are divided into each block having the 360 data(Figure 8.). They are calculated as the number of row weight at once. Finishing the one CNU block, 90 CNU blocks is processed one by one in serial. To calculate the CNU block is required to acknowledge the respective block index and the index that displays the beginning point in each block. The operation performed in the BNU is very simple that it has just the block index owing to knowing at the beginning point in each block.

[4]M. Sipser and D.A.Spielman, "Expander Codes, "IEEE Trans. Information Theory, vol.42, pp.1720-1722, Aug. 1996

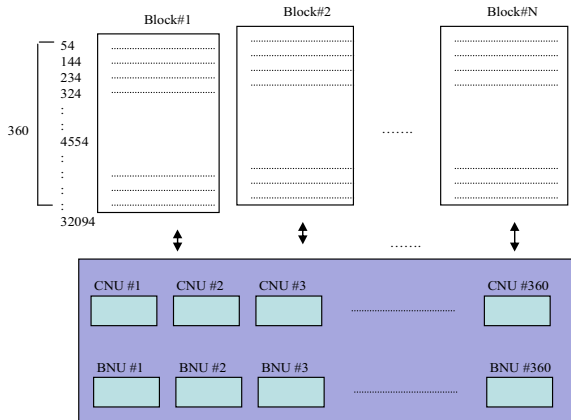

Figure 8. Partially parallel decoder scheme

The number of CNU and BNU block processing the partially parallel algorithm and the fully parallel algorithm are listed in Table 2.

TABLE 2. The number of block according to partially parallel

R	A matric	B matric $q*2$ ( $q=M/360$ )	Receive bir save block	Total block
1/4	270	$135*2=270$	180(64800/360)	720
1/3	360	$120*2=240$	180	180
2/5	432	$108*2=216$	180	822
1/2	$54*3+36*8=450$	$90*2=18$	180	810
3/5	548	$72*2=144$	180	872
2/3	$12*13+48*3+60*3=480$	$60*2=120$	180	780
3/4	540	$45*2=90$	180	810
4/5	567	$36*2=72$	180	819
5/6	600	$30*2=60$	180	840
8/9	480	$20*2=40$	180	700
9/10	540	$18*2=36$	180	756

## 6. Conclusion

In this paper, we analyzed LDPC codes of encoding and decoding algorithm at the respective code rates in DVB-S2 standard proposed HNS[1]. On the basis of analysis we compared the performance. Also we have studied the two methods such as the fully parallel decoder and the partially parallel decoder concerning decoding method required the number of memory to design implementation on the FPGA or ASIC. In reference to analysis consequence, we are able to implement the LDPC codes on FPGA.

## References

- [1] Draft ETSI EN 302 307, Digital Video Broadcasting(DVB); News Gathering and other broadband satellite applications, 2004. 6.
- [2] R. G. Gallager, "Low-Density Parity-Check Codes," IRE trans. information theory, vol.8, PP.21-28, 1962.
- [3] D. J. C. Mackay and R. M. Neal, "Near Shannon Limit Performance of Low-Density Parity-Check Codes," Electron. Letter, Vol.32, PP. 1645-1646, Aug. 1996.