

A MULTITARGET ADAPTIVE ARRAY ALGORITHMS FOR WIRELESS CDMA SYSTEMS

Hassan Mohamed Elkamchouchi
 Senior Member, IEEE
 719 Alhoryia Avenue st., Loran, Alexandria, Egypt
 E-mail: Helkamchouchi@ieee.org

Mohamed Abd Elsalam Mofeed Adam
 Suez Oil Company (SUCO)
 23 Alfred Layan st., Boulkly, Alexandria, Egypt
 E-mail: M_adam19@yahoo.com

1. Introduction

The increasing demand for mobile communication capacity in limited RF spectrum motivates the need for new techniques to improve spectrum utilization. One approach for increasing spectrum efficiency in digital cellular is the use of spread spectrum *code division multiple access* (CDMA) technology. Another approach is by using the adaptive antenna array in a CDMA system [4] [5], the amount of co-channel interference from users within the same cell as well as neighboring cells can be reduced, and therefore the system capacity can be increased. There exist many adaptive algorithms that must have the ability to separate and extract each user's signal simultaneously.

In this paper, we investigate the performance of two different blind adaptive array algorithms. The first one is *least-squares despread respread multitarget array* (LSDRMATA) [1] [2] [3], which utilizes the information of the spreading signals of different users in a CDMA system to adapt the weight vectors of a multitarget beamformer. The second one is *least-squares despread respread multitarget constant modulus algorithm* (LSDRMTCMA) [1] [2] [3], which combines the information of the spreading signal and the constant modulus property of the transmitted signal in the adaptation of the weight vectors. The performance test assume that the channel has *additive white gaussian noise* (AWGN). In section 2, we describe the signal model. Section 3 presents the multitarget adaptive array algorithms, and their derivation. In section 4, we present the simulation results of the different algorithms. Finally, section 5 presents the conclusions.

2. Signal Model

A block diagram of a multitarget adaptive beamformer with M antenna elements and Q output ports is shown in fig. 1. The M antenna elements are assumed to be equally spaced along a line with interelement spacing d , i.e., the array is a *uniform linear array*. Suppose there are q signals $s_1(t), \dots, s_q(t)$, all centered around a known frequency, say f_c , each impinging on the array with a *direction of arrival* (DOA) of $\theta_i, i=1,2,\dots,q$, which is measured clockwise from the broadside of the array. The complex envelope representation of the $M \times 1$ array input data vector $\mathbf{x}(t) = [x_1(t), \dots, x_M(t)]^T$ may be modeled as

$$\mathbf{x}(t) = \mathbf{A}(\Theta)\mathbf{s}(t) + \mathbf{n}(t) \tag{1}$$

where $\mathbf{s}(t) = [s_1(t), \dots, s_q(t)]^T$ is the complex envelope representation of the $q \times 1$ source vector, $\mathbf{n}(t) = [n_1(t), \dots, n_M(t)]^T$ is an $M \times 1$ additive noise vector, and $\mathbf{A}(\Theta) = [\mathbf{a}(\theta_1), \dots, \mathbf{a}(\theta_q)]$ is the array response matrix with the steering vector $\mathbf{a}(\theta_i)$ as its i th column. For a *direct sequence CDMA* (DS-CDMA) system with p co-channel users, the impinging signal $s_{il}(t)$ from the l th path of the i th user may be expressed as

$$s_{il}(t) = \sqrt{2P_{il}} b_i(t-\tau_{il}) c_i(t-\tau_{il}) \exp\{-j\phi_{il}\} \quad i = 1, \dots, p, \quad l = 1, \dots, L_{Mi} \tag{2}$$

where L_{Mi} is the maximum number of distinguishable multipath components of the i th user, and $P_{il}, b_i(t), c_i(t), \tau_{il}$, and ϕ_{il} are the power, the data signal, the spreading signal (PN sequence), the time delay, and the random phase of the signal from the l th path of the i th user, respectively. The data signal $b_i(t)$ and the spreading signal $c_i(t)$ are given by

$$b_i(t) = \sum_{n=-\infty}^{\infty} b_{in} \Psi(t - nT_b), \quad c_i(t) = \sum_{m=-\infty}^{\infty} c_{im} \Psi(t - mT_c) \tag{3}$$

where $b_{in} \in \{-1, +1\}$ is the n th data bit of i th user, $\Psi(t-nT_b)$ is a unit rectangular pulse of bit period duration T_b , $c_{im} \in \{-1, +1\}$ is the m th chip of i th user, and $\Psi(t-mT_c)$ is a unit rectangular pulse of chip

period duration T_c . In fig. 1, the output signal of the i th port is $y_i(k) = \mathbf{w}_i^H(k) \mathbf{x}(k)$, where $\mathbf{w}_i(k) = [w_{i1}(k), \dots, w_{iM}(k)]^T$ is the adaptive weight vector adjusted by the adaptive control processor using a multitarget-type algorithm.

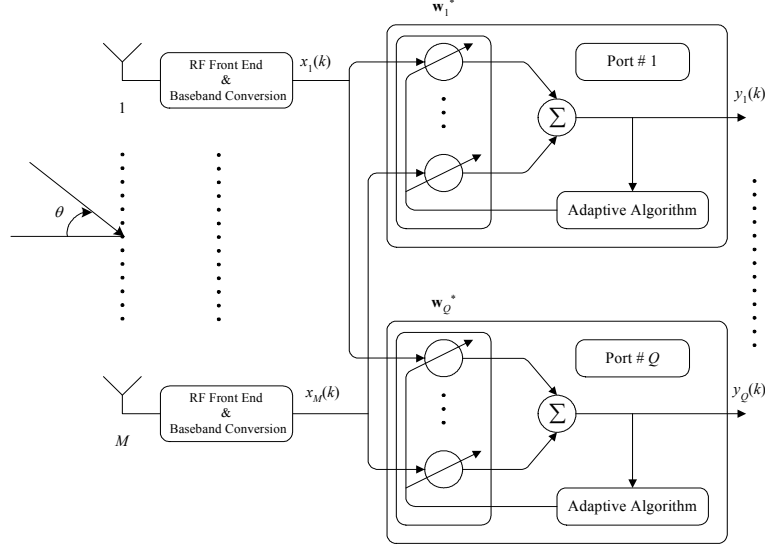

Fig. 1 The structure of a Multitarget Adaptive Beamformer with M Antenna Elements and Q Output Ports

3. Multitarget Adaptive Array Algorithms

A. Least-Squares Despread Respread Multitarget Constant Modulus Algorithm (LSDRMTCMA)

Here we propose the LSDRMTCMA algorithm [1]. In the base station of a CDMA system, the spreading signals of all users are previously known. So to detect the data bit of i th user, the received signal $y_i(t)$ in fig. 2 is correlated with the time delayed spreading signal of i th user, $c_i(t - \tau_{li})$, where τ_{li} is previously known and the correlation output is sent to the detector, which makes a decision based on the correlation output. If the n th data bit of the i th user is detected correctly by the detector, i.e., $\hat{b}_{in} = b_{in}$, where \hat{b}_{in} is the detector output, the waveform of the i th user's transmitted signal during time period $[(n-1)T_b, nT_b]$ can be obtained by respreading the detected data bit, \hat{b}_{in} , with the PN sequence of the i th user, $c_i(t)$. This respread signal can then be used in the beamformer to adapt the weight vector for i th user. The adaptive algorithm that uses this despread and respread technique is referred to LSDRMTCMA algorithm. Fig. 2 shows the block diagram of the LSDRMTCMA for i th user. In fig. 2, $r_i(t)$ is given by

$$r_i(t) = a_{PN} r_{iPN}(t) + a_{CM} r_{iCM}(t) \quad (4)$$

where $r_{iPN}(t) = \hat{b}_{in} c_i(t - \tau_i)$ $(n-1)T_b \leq t < nT_b$ (5)
is the time delayed version of the respread signal of i th user, and

$$r_{iCM}(t) = \frac{y_i(t)}{|y_i(t)|} \quad (6)$$

is the complex-limited output of i th user, and a_{PN} and a_{CM} are real positive weight coefficients for the respread signal and the complex-limited output of i th user, respectively. The coefficients a_{PN} and a_{CM} should satisfy the condition:

$$a_{PN} + a_{CM} = 1, \quad a_{PN}, a_{CM} > 0 \quad (7)$$

Let $y_i(k)$ and $r_i(k)$ denote the k th sample of $y_i(t)$ and $r_i(t)$, respectively, in a digital system. The LSDRMTCMA tries to adapt the weight vector \mathbf{w}_i to minimize the cost function

$$F(\mathbf{w}_i) = \sum_{k=1}^K |y_i(k) - r_i(k)|^2, \quad F(\mathbf{w}_i) = \sum_{k=1}^K |\mathbf{w}_i^H \mathbf{x}(k) - r_i(k)|^2 \quad (8)$$

where K is the data block size and is set equal to the number of samples in one bit period. Using the extension of Gauss' method, we obtain the equations for LSDRMTCMA for the i th user

$$\mathbf{y}_i(l) = [\mathbf{w}_i^H(l) \mathbf{X}(l)]^T, \quad \mathbf{y}_i(l) = [y_i(1+lK), y_i(2+lK), \dots, y_i((1+l)K)]^T \quad (9)$$

$$\hat{b}_{il} = \text{sgn} \left\{ \text{Re} \left[\sum_{k=1+lK}^{(1+l)K} y_i(k) c_i(k - k_{\tau_i}) \right] \right\} \quad (10)$$

$$\mathbf{r}_{iPN}(l) = \hat{b}_{il} [c_i(1+lK - k_{\tau_i}), c_i(2+lK - k_{\tau_i}), \dots, c_i((1+l)K - k_{\tau_i})]^T \quad (11)$$

$$\mathbf{r}_{iCM}(l) = \left[\frac{y_i(1+lK)}{|y_i(1+lK)|}, \frac{y_i(2+lK)}{|y_i(2+lK)|}, \dots, \frac{y_i((1+l)K)}{|y_i((1+l)K)|} \right]^T \quad (12)$$

$$\mathbf{r}_i(l) = a_{PN} \mathbf{r}_{iPN}(l) + a_{CM} \mathbf{r}_{iCM}(l) \quad (13)$$

$$\mathbf{w}_i(l+1) = [\mathbf{X}(l) \mathbf{X}^H(l)]^{-1} \mathbf{X}(l) \mathbf{r}_i^*(l) \quad (14)$$

where $c_i(k)$ is the k th sample of the spreading signal of i th user, k_{τ_i} is the number of samples corresponding to τ_i the delay of i th user, \hat{b}_{il} is the estimate of l th bit of i th user, and $\mathbf{r}_i(l)$ is the estimated vector of the signal waveform of i th user over the l th bit period. The choice of a_{PN} and a_{CM} can affect the resulting beam pattern and thus the performance of the system.

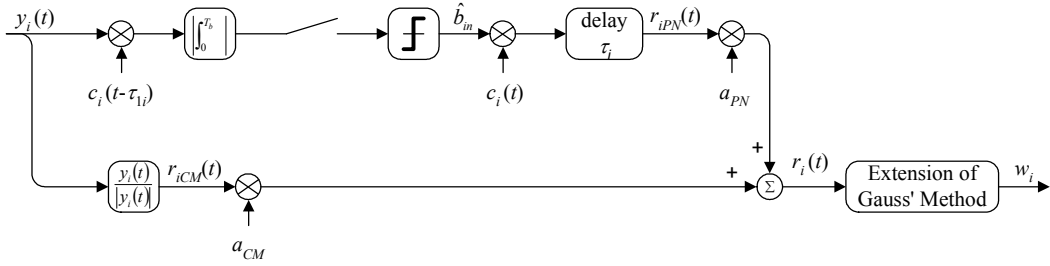

Fig. 2 The LSDRMTCMA Block Diagram for i th User

B. Least-Squares Despread Respread Multitarget Array (LSDRMTA)

The derivation of the LSDRMTA [1] is got if we set a_{CM} in equation (13) to zero, so the LSDRMTCMA becomes the LSDRMTA, therefore the LSDRMTA can be viewed as a special case of the LSDRMTCMA. Fig. 3 shows the block diagram of the LSDRMTA for i th user.

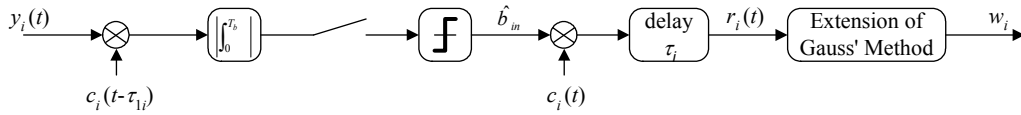

Fig. 3 The LSDRMTA Block Diagram for i th User

4. Simulation Results and Discussion

In this section we compare the performance of the two algorithms, LSDRMTCMA, and LSDRMTA under using AWGN channel [2].

A. Description of System Parameters

For comparison purposes, we consider a DS-CDMA system with a processing gain, N , equal to 31. The modulation scheme used in the system is *binary phase shift keying* (BPSK), the carrier frequency f_c is 1800 MHz, and the data bit rate R_b is 10 kbps. An 8-element uniform linear array with half wavelength spacing between the elements is assumed to be located at the base station. The number of ports Q is 8. The sampling rate is four times the chip rate. The E_b/N_o for all users is set to 10 dB. The ratio of coefficients $a_{PN}:a_{CM}$ is 2:1. The DOA of the signals is set to $\{-40^\circ, -30^\circ, -20^\circ, -10^\circ, 10^\circ, 20^\circ, 30^\circ, 40^\circ\}$ for user number one, user number 2, ..., and user number 8, respectively.

B. Simulation Results in AWGN Channel

In the AWGN channel case, we assume perfect power control in the base station, so all the signals impinging on the array have the same power level. In fig. 4, we show the performance behavior of all ports in case of LSDRMTCMA and LSDRMTCMA algorithms using dynamic data block, which means K is varied each bit period. We found that the performance is the same approximately for

the two algorithms. The performance behavior of all ports attenuated to zero dB level, which means that the used spreading signal (PN sequence) satisfy a low cross correlation so all other users are nulled out and remain only the auto correlated user. In fig. 5, we show the directional pattern of port #4 in case of LSDRMATA and LSDRMTCMA algorithms using dynamic data block. The port is assigned to a certain user (for user incident at -10°) and accordingly a peak occurs in the direction of arrival of that user's signal, but nulls occur in the direction of arrival of all other users' signals.

5. Conclusions

It is known that, The processing structure of LSDRMATA algorithm utilizes the information of the spreading signals of different users in a CDMA system to adapt the weight vectors of a multitarget beamformer, but the processing structure of LSDRMTCMA combines the information of the spreading signal and the constant modulus property of the transmitted signal in the adaptation of the weight vectors. Then from the simulation and the processing structure, it is clear that the information of the spreading signals is strong enough to extract a user from multiuser system.

References

- [1] Joseph C. Liberti, JR. and Theodore S. Rappaport., "Smart antennas for wireless communications," Prentice Hall PTR, New Jersey, 1999.
- [2] Zhigang Rong, Theodore S. Rappaport, Paul Petrus, and Jeff H. Reed, "Simulation of multitarget adaptive array algorithms for wireless CDMA systems," IEEE Vehicular Technology Conference, pp 1-5, May 1997.
- [3] Zhigang Rong, "Simulation of adaptive array algorithms for CDMA systems," M.S. thesis, Virginia Tech, Blacksburg, VA, September 1996.
- [4] B. Suard, A. F. Naguib, G. Xu, and A. Paulraj, "Performance of CDMA mobile communication systems using antenna arrays," Proc. IEEE ICASSP, vol. 4, pp. 153-156, April 1993.
- [5] R. T. Compton, Jr., "Adaptive antennas, concept and performance," Prentice Hall, Englewood Cliffs, New Jersey, 1988.

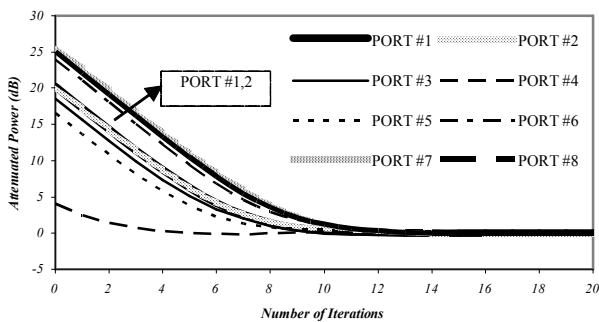

(a)

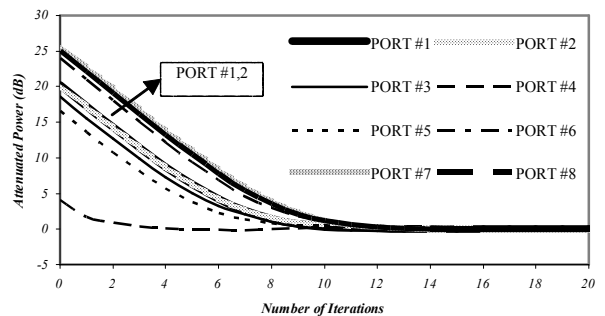

(b)

Fig. 4 Performance Behavior of all Ports in Case of (a) LSDRMATA and (b) LSDRMTCMA Algorithms using Dynamic Data Block

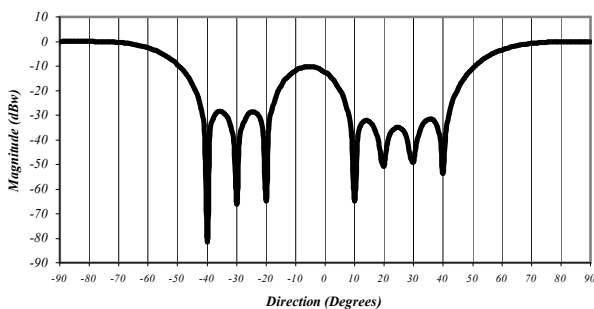

(a)

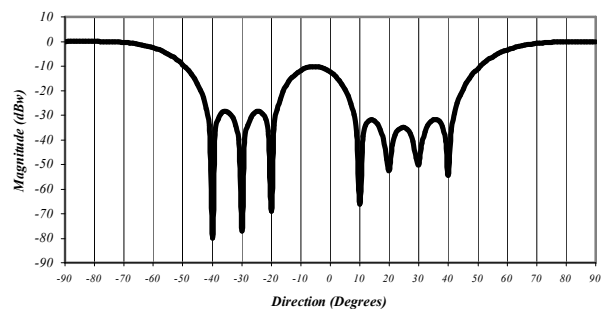

(b)

Fig. 5 Directional Pattern of Port #4 (for user incident at -10°) in Case of (a) LSDRMATA and (b) LSDRMTCMA Algorithms using Dynamic Data Block