

Small-size Half-loop Frame Antenna Integrated with a USB Connector and Having a Narrow Ground Clearance for the LTE Metal-framed Smartphone

Li-Yu Chen and Kin-Lu Wong

Department of Electrical Engineering, National Sun Yat-Sen University, Kaohsiung 80424, Taiwan

Abstract – A small-size half-loop frame antenna integrated with a USB connector and having a 3-mm narrow ground clearance for the LTE metal-framed smartphone is presented. The frame antenna uses a part of metal frame as antenna’s radiator and is promising to achieve wide bandwidths for mobile communication. The frame antenna can also integrate with a USB connector, which serves as the data port of the smartphone. The frame antenna is based on the simple half-loop antenna structure to cover 824~960 and 1710~2690 MHz for the LTE operation. Details of the proposed antenna are presented and discussed.

Index Terms — Mobile antennas, smartphone antennas, half-loop antennas, frame antennas, LTE antennas.

1. Introduction

For the modern slim smartphone with a thin thickness, a metal frame is attractive to be disposed around the casing thereof to enhance its mechanical robustness [1], [2]. Recently, some loop antenna designs combine metal rings or bezel antennas into the frame of smartphone to achieve the LTE (long term evolution) operation [1], [2]. However, for these reported loop antenna designs, they mainly operate at their one-wavelength resonant mode, which have a large antenna size. Moreover, a wide ground clearance of 10 mm is required for the antenna to cover the LTE operation. This is a significant limitation in equipping a large display panel in the smartphone. This leads to the present study in achieving the frame antenna with a narrow ground clearance.

In this paper, to achieve acceptable operating bandwidths with a short antenna length and narrow ground clearance, the frame antenna based on the simple half-loop antenna structure [3] is presented. The frame antenna can cover 824~960 and 1710~2690 MHz for the LTE operation. Experimental results are presented. The user’s hand effects on the antenna performance are also analyzed.

2. Proposed Antenna

Fig. 1 shows the geometry of the half-loop frame antenna. To show the antenna structure more clearly, Fig. 2 shows the equivalent structure of the proposed antenna. The smartphone with a main circuit board of size $150 \times 76.4 \text{ mm}^2$ and a rectangular-ring metal frame of width 6 mm around the

edges thereof is considered in this study. The frame antenna comprises a longer half loop (AA’BB’) and a shorter half loop (DEFF’). By adding a low-band and a high-band matching circuit [4], the antenna can respectively cover the LTE low band (824~960 MHz) and the LTE high band (1710~2690 MHz).

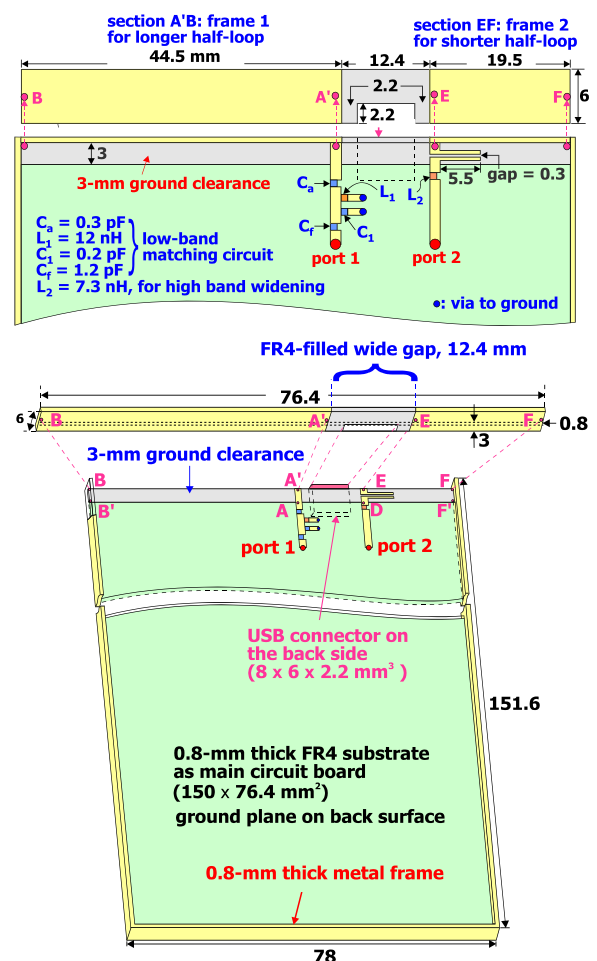

Fig. 1. Geometry of the half-loop frame antenna.

Fig. 3 shows the simulated return loss for the proposed antenna, the case with the low-band feed only (Ant1 with port 1), and the case with the high-band feed only (Ant2 with

port 2). Results show that the return loss of Ant1 is almost the same with that in the low band of the proposed antenna. The return loss of Ant2 is also similar to that in the high band of the proposed antenna. The results indicate that the low-band and high-band structures can be designed respectively, and the two feeds can also be controlled independently.

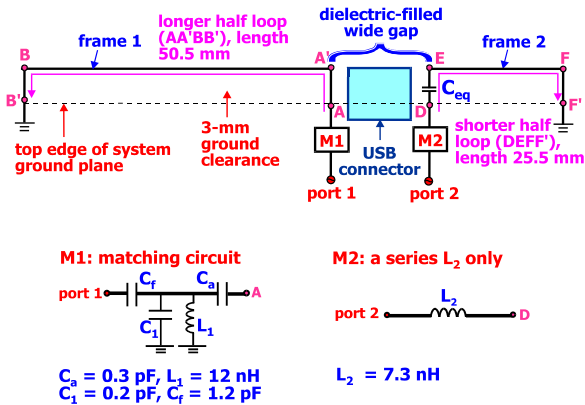

Fig. 2. Equivalent structure of the proposed antenna.

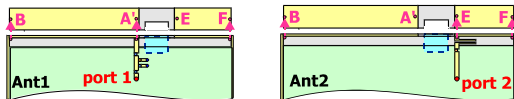
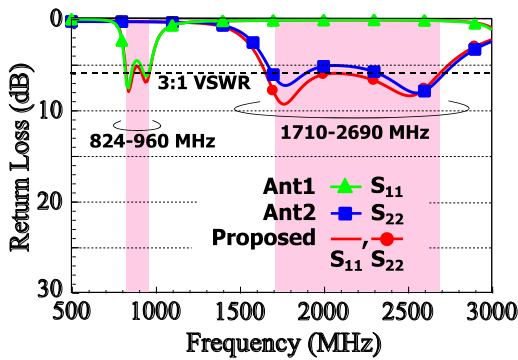

Fig. 3. Simulated return loss for the proposed antenna, the case with the low-band feed only (Ant1 with port 1), and the case with the high-band feed only (Ant2 with port 2).

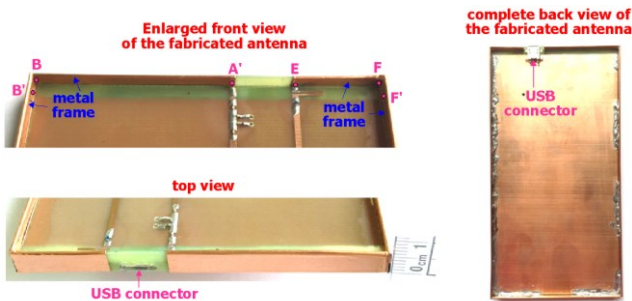

Fig. 4. Photos of the fabricated antenna.

3. Experimental Results

The photos of the fabricated antenna are shown in Fig. 4. Fig. 5 shows the measured and simulated S parameters for the fabricated antenna. Fair agreement between the measured

data and simulated results is seen. The measured and simulated antenna efficiencies for the fabricated antenna are shown in Fig. 6. In the low and high bands, the measured antenna efficiencies are respectively about 49~64% and 70~81%, which is acceptable for practical applications in mobile devices. More results will be provided in the presentation.

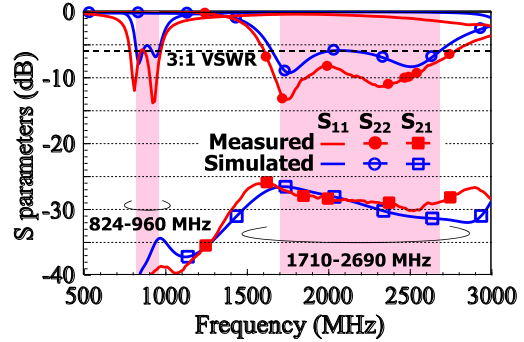

Fig. 5. Measured and simulated S parameters for the fabricated antenna.

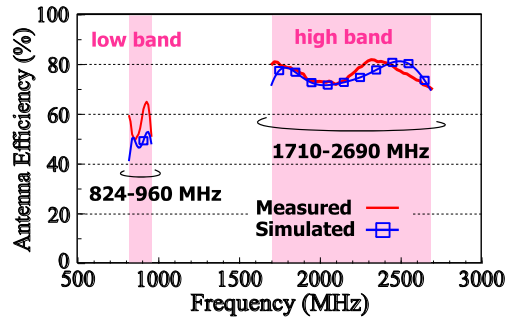

Fig. 6. Measured and simulated antenna efficiencies for the fabricated antenna.

4. Conclusion

A small-size half-loop frame antenna integrated with a USB connector for the LTE metal-framed smartphone has been proposed. With a narrow ground clearance of 3 mm only, the two half-loop frame antenna can provide two operating bands of 824~960 and 1710~2690 MHz for the LTE operation. The fabricated antenna also shows good radiation characteristics. With the obtained results in this study, the antenna is promising for application in the metal-framed smartphone with a narrow region between the display panel and the metal frame at the short-edge thereof.

References

- [1] Y. L. Ban, Y. F. Qiang, Z. Chen, K. Kang, and J. H. Guo, "A dual-loop antenna design for hepta-band WWAN/LTE metal-rimmed smartphone applications," *IEEE Trans. Antennas Propag.*, vol.63, pp. 48-58, Jan. 2015.
- [2] K. Zhao, S. Zhang, K. Ishimiya, Z. Ying, and S. He, "Body-insensitive multimode MIMO terminal antenna of double-ring structure," *IEEE Trans. Antennas Propag.*, vol. 63, pp. 1925-1936, May 2015.
- [3] K. L. Wong and W. J. Lin, "Communication device and antenna structure therein," U.S. Patent No. 8,823,595 B2, Sep. 2014.
- [4] K. L. Wong and L. Y. Chen, "Small-size LTE/WWAN tablet device antenna with two hybrid feeds," *IEEE Trans. Antennas Propag.*, vol. 62, pp. 2926-2934, Jun. 2014.