



# Cloud Computing and the IEEE

**Doug Zuckerman**

Conferences Track Leader

IEEE Cloud Computing Initiative

# Computing Waves

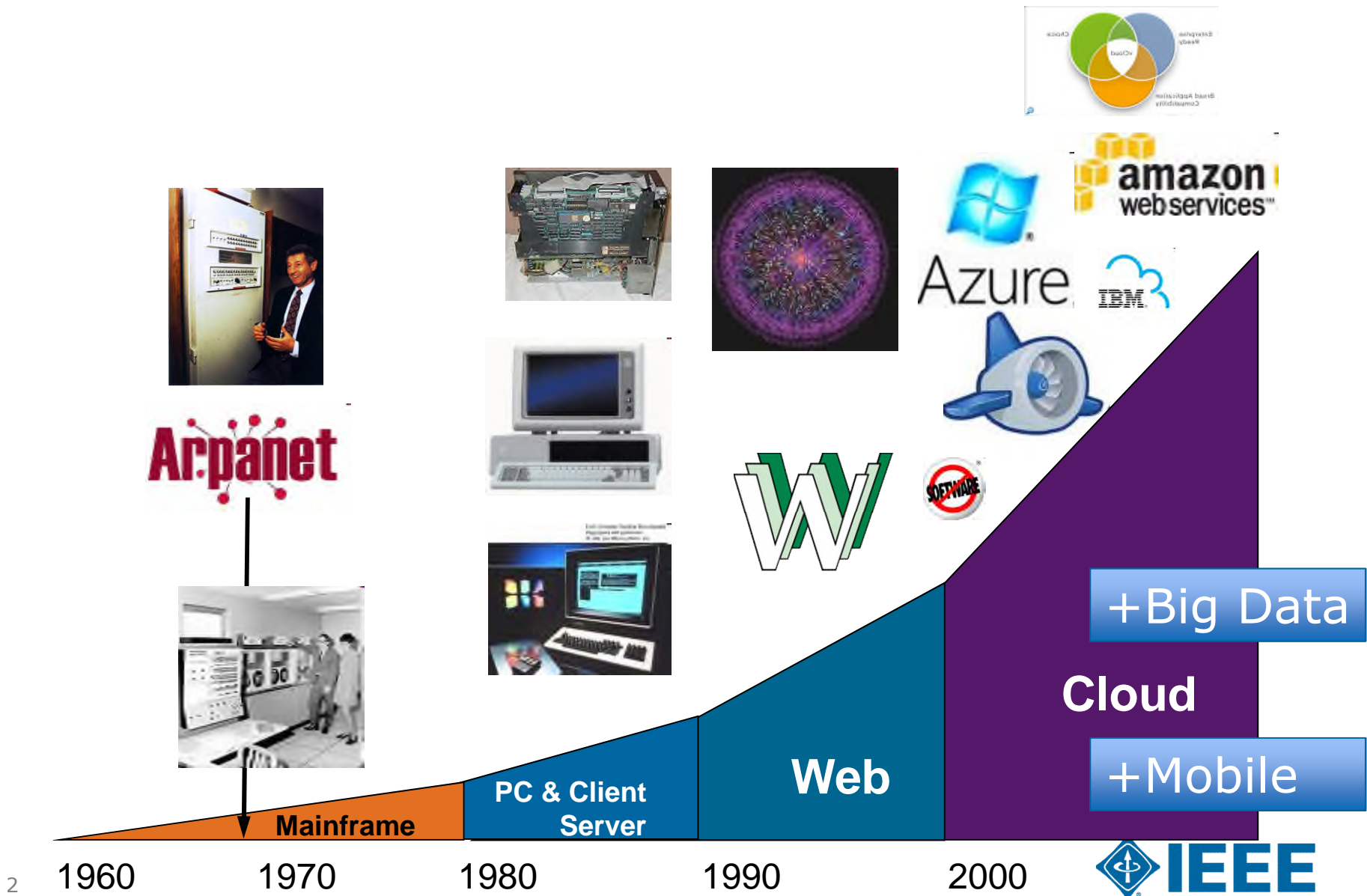

# Why should we care about cloud computing?

✓ It's big business



✓ It's creating new jobs

✓ Worldwide – governments have made cloud computing a priority

✓ It affects you, your family, your friends, everyone!

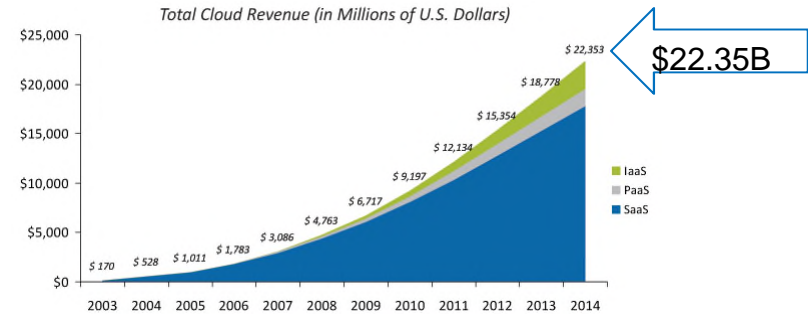

amazon.com

Walmart  
Save money. Live better.



iCloud

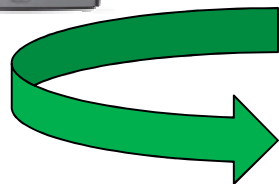

Networking, management, security,  
reliability, cost, mobility, power

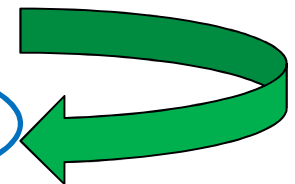

# Cloud Computing Infrastructure and Management

Cloud computing technology contributes to network management across computing and telecommunications areas

- Cloud infrastructure and its management can be defined across multiple levels of service providers
- Unlike traditional implementations, cloud infrastructure services can be hosted across multiple distinct platforms and with different providers --- where software, hardware, network and data are “virtually” located and hopefully offers a limitless resource
- Migration to a cloud infrastructure does not necessarily involve accessing all the requirements in one traditional data center, but instead providing a more cost-effective set of services distributed across multiple providers in multiple locations

# Cloud Computing and The IEEE

- The IEEE Cloud Computing Initiative (CCI) is uniquely qualified and positioned to play a leading role in the development of cloud computing globally and to help guide and shape its future
- IEEE has provided a venue for cloud-related activities for years
  - The Initiative has increased collaboration across multiple societies
- IEEE CCI is leading coordinated and collaborative effort on cloud opportunities across IEEE
  - “One IEEE”

**IEEE Xplore®**  
DIGITAL LIBRARY

the **institute**

**EAB**

IEEE  **computer society**

**MGA**

IEEE  
*Signal Processing Society*



IEEE  
**COMMUNICATIONS  
SOCIETY**



**ieee.tv**

Tune in to where technology lives.

IEEE  
**VTS**  
Vehicular Technology Society  
Connecting the Mobile World



IEEE Consumer Electronics Society

IEEE **Computational Intelligence Society**

**Systems, Man,  
& Cybernetics  
Society**

IEEE **Control Systems Society**

**IEEE STANDARDS ASSOCIATION**

IEEE  
**CLOUD COMPUTING**



**Reliability Society**

IEEE  
**photonics**  
SOCIETY  
Transforming science into technology™

**IEEE**

IEEE  
**Biometrics Council**

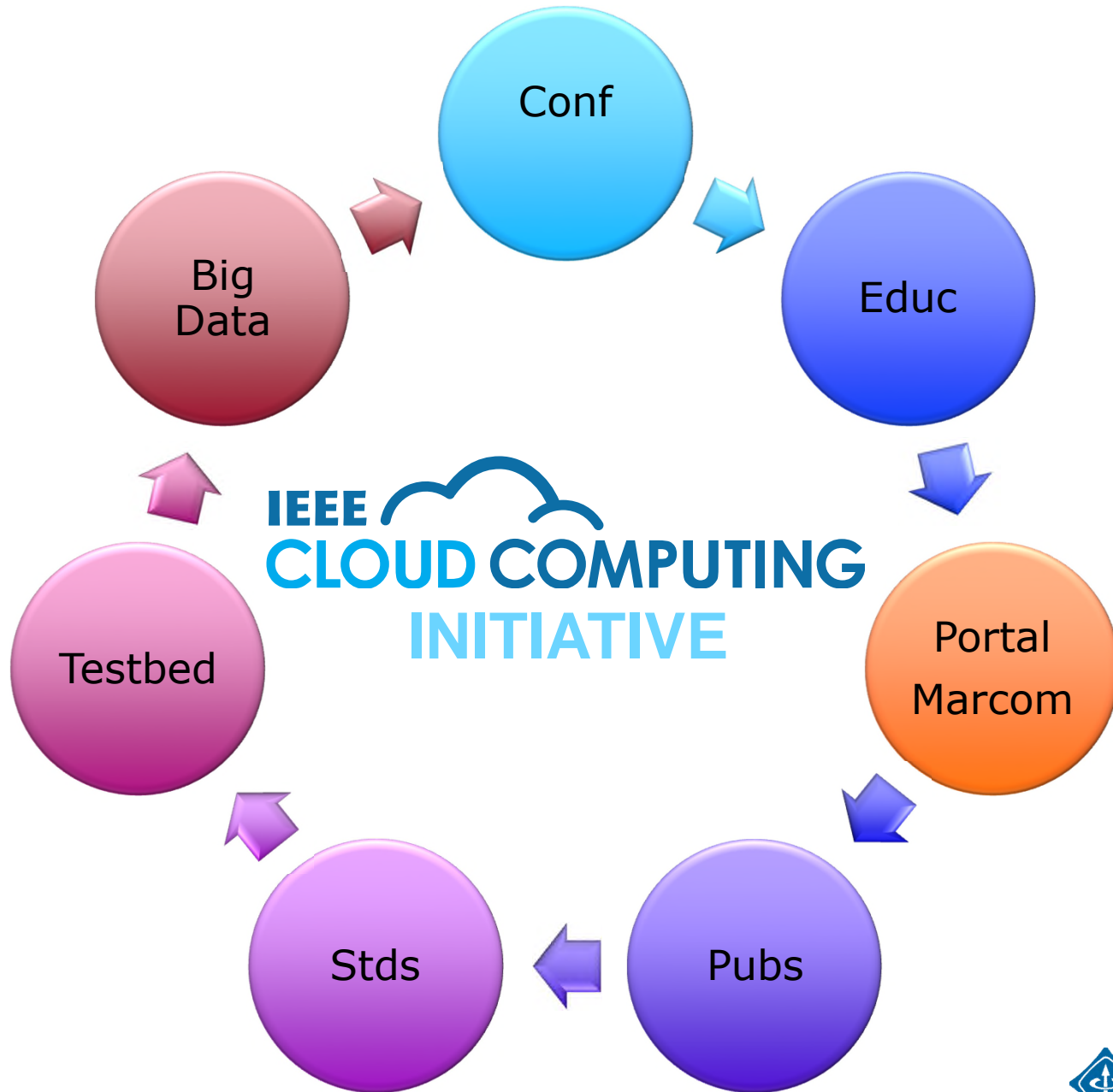

# What is CCI doing?

## Conferences Track

- IEEE Cloud Computing for Emerging Markets
- Asian Pacific Cloud Congress
- Latin America Cloud Congress
- European Cloud Congress
- North America Cloud Symposium
- World Forum

## Intercloud Testbed Track

- Infrastructure environment for applications (P2302)
- Supports education, conferences, pubs

## Web Portal Track

- Dedicated website
- Social media
- Video
- Articles
- Newsletter
- Blog

## Publications Track

- Transactions
- Magazine
- Letters

## Education Track

- eLearning modules
- Continuing education
- Video of conference talks, section/chapter talks

## Big Data Track

- Transactions Pub
- Leadership

## Standards Track

- P2301 Cloud portability, commonality
- P2302 Cloud to cloud interoperability

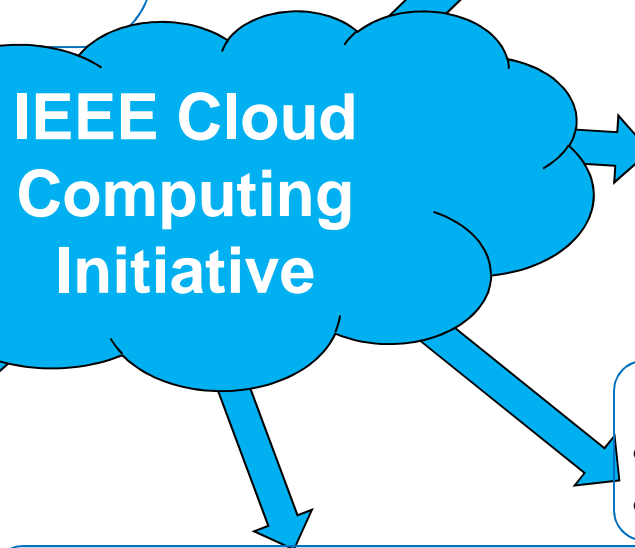

# Project Milestones and Roadmap: 2013

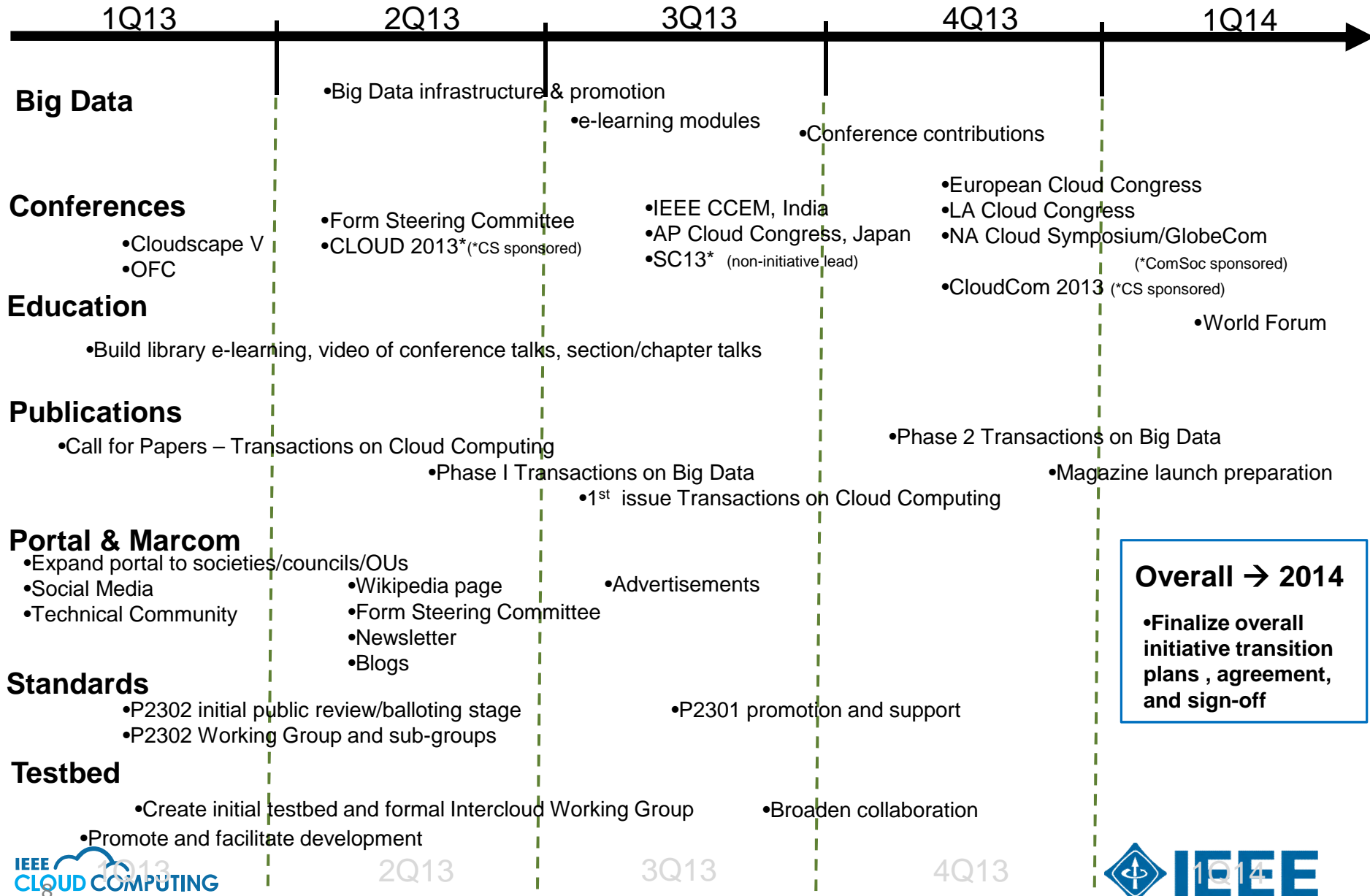

**Overall → 2014**

- Finalize overall initiative transition plans , agreement, and sign-off



# IEEE Cloud Computing Conferences

Enable thought leaders, users, vendors, and interest groups opportunities to exchange knowledge and discuss cloud computing issues.

**Asian Pacific Cloud Congress**, 22-26 July 2013, Kyoto, Japan ([compsac.cs.iastate.edu](http://compsac.cs.iastate.edu)), associated with COMPSAC

**Cloud Computing for Emerging Markets (CEM)**, 16-18 October 2013, Bangalore, India ([cloudcomputing.ieee.org/ccem](http://cloudcomputing.ieee.org/ccem))

**Latin America Cloud Congress**, 9-10 December 2013, Maceió-Alagoas, Brazil - LATINCLOUD ([www.ieee-latincloud.org/2013](http://www.ieee-latincloud.org/2013))

**European Cloud Congress**, 2-5 December 2013, Bristol, UK ([2013.cloudcom.org](http://2013.cloudcom.org)), associated with CloudCom

**North America Cloud Congress**, 9-13 December 2013, Atlanta, Georgia, US ([www.ieee-globecom.org](http://www.ieee-globecom.org)), co-located with GLOBECOM



# Conferences cross-promoted across IEEE

**IEEE PHOTONICS CONFERENCE 2013**  
8 - 12 September 2013

**IEEE INTERNATIONAL CONFERENCE ON COMMUNICATIONS**  
9-13 JUNE • BUDAPEST, HUNGARY

**IEEE CLOUD 2013**  
IEEE 6th International Conference on Cloud Computing  
June 27-July 2, 2013, Santa Clara Marriott, CA, USA (Center of Silicon Valley)

Welcome to the **IEEE PHOTONICS CONFERENCE 2013**  
8 - 12 September 2013  
Hyatt Regency Bellevue  
Bellevue Washington USA  
(Seattle Metro Area)

**IEEE ICC '13: BRIDGING THE BROADBAND DIVIDE**

WELCOME MESSAGES FROM LAJOS HANZO AND ANDREAS F. MOLISCH  
WELCOME MESSAGE FROM CHRISTOPHER MATTHESEN

WELCOME

On behalf of the IEEE Photonics Society and my fellow conference committee members Susana Noda and David Plant, I wish you a very warm welcome to the IEEE Photonics Conference (IPC) 2013. IPC 2013, to be held at the Hyatt Regency Bellevue, Washington, USA, from 8-12 September 2013, is the latest in the series of conferences which were formerly known as the LEOS Annual Meeting, and which provide a premier digital forum for scientists and engineers in the field of photonics.

**IEEE PHOTONICS CONFERENCE 2013**  
8 - 12 September 2013

**Sponsors** Marketing and Sponsorship Opportunities

We have 3 good reasons why your organization should consider sponsoring an IEEE/Photonics Society Conference!

- To enhance your image while shaping consumer attitudes
- To Drive Sales
- To create positive publicity & heighten visibility

**In recognizing today's economic realities, the Photonics Society is open for individualized sponsorships opportunities to meet any budget. Please contact Mary Hendrickx at +1 732 562 3897 or m.hendrickx@ieee.org today so that she can tailor a sponsorship specific to your needs.**

Benefits of Sponsorship include:

**CALL FOR PAPERS >>** **MEDIA CENTER >>**

IEEE ICC '13 EXHIBITORS PATRONS

PLATINUM GOLD SILVER BRONZE

Ericsson, National Instruments, Cisco, Agilent Technologies, Cambridge University Press, Springer, Wiley, Toshiba, Hite, GeBIT, Intel, IEEE Cloud Computing.

**About CLOUD 2013**

"Change we are leading" is the theme of CLOUD 2013

Cloud Computing has become a scalable services consumption and delivery platform in the field of Services Computing. The technical foundations of Cloud Computing include Service-Oriented Architecture (SOA) and Virtualizations of hardware and software. The goal of Cloud Computing is to share resources among the cloud service consumers, cloud partners, and cloud vendors in the cloud value chain. The resource sharing at various levels results in various cloud offerings such as infrastructure cloud (e.g. hardware, IT infrastructure management), software cloud (e.g. SaaS focusing on middleware as a service, or traditional CRM as a service), application cloud (e.g. Application as a Service, UML modeling tools as a service, social network as a service), and business cloud (e.g. business process as a service).

**IEEE ICC '13 EXHIBITORS PATRONS**

Ericsson, National Instruments, Cisco, Agilent Technologies, Cambridge University Press, Springer, Wiley, Toshiba, Hite, GeBIT, Intel, IEEE Cloud Computing.

**CONFERENCE PLANNER**

Mary S. Hendrickx  
Senior Conference Planner  
Phone +1 732 562 3897  
Fax +1 732 562 3824  
m.hendrickx@ieee.org

IEEE Photonics Society  
445 Hoes Lane  
Piscataway, NJ 08855-1331  
USA  
www.photonicsociety.org

Sign up for email updates  
Register for the conference  
Exhibitors information  
Become a sponsor

**BECOME A MEMBER OF THE IEEE PHOTONICS SOCIETY**

**IEEE CLOUD COMPUTING**

IBM, SAP, HP, HUAWEI



Sponsored by the IEEE Cloud Computing Initiative

Follow:



Share:



**SIGN UP FOR**  
EMAIL UPDATES

## CCEM 2012 Photos

[View All](#)



## Conference Overview

This second **IEEE International Conference on Cloud Computing for Emerging Markets (CCEM)** follows the highly successful launch of the first edition in 2012. The goal of the CCEM conference is to address the unique challenges and opportunities of cloud computing for emerging markets in a high quality event that brings together industry, government, and academic leaders in cloud computing from around the world, particularly from emerging markets.

## Latest Information

**CCEM early bird registration ends Saturday, 31 August!**  
[Register now](#)

**Accepted Authors, please see final paper submission instructions**  
[Author information](#)

**CCEM 2013 Hotel Reservation information now available**  
[Reserve your room today](#)

**CCEM 2013 Sponsorship and Participation Opportunities**  
[Go ahead to brochure](#)

# Register for CCEM2013

## Invited Talks

**NEW** "A Roadmap for Cloud Computing Innovation in India" white paper released by Dr. Sam Pitroda, Chairman of the National Innovation Council for India

### Topics

- Cloud computing: overview, opportunities, issues, and challenges
- An emerging market view of cloud computing in government, public sectors
- Security and compliance issues in cloud computing and their implications in emerging markets
- Networking in the cloud computing era -- how emerging markets are changing the game
- Telcos as cloud providers -- opportunities and challenges in emerging markets
- Emerging standards in cloud computing

## Keynote Speakers



**Renu Budhiraja,**  
Sr. Director & HoD State Data Centers,  
e-Governance Division,  
DeitY

[Renu Budhiraja](#)

- 19 April 2013:** Sponsorship and Exhibit Proposals Due
- 17 June 2013:** Final date for Paper Submissions, Demo Proposals and Tutorial Proposals; Tutorial Acceptance Notification
- 22 July 2013:** Acceptance Notification of Papers/Demos
- 16 August 2013:** Camera-ready papers, demo descriptions due
- 31 August 2013:** Early registration deadline

## Sponsored by





## WELCOME TO IEEE LATIN CLOUD 2013

The 2013 IEEE Latin America Conference on Cloud Computing and Communications (LatinCloud 2013) is the second edition of a conference that quickly has become the premier forum for discussions of recent advances in cloud computing and communications, virtualization, utility computing, grid computing, service-oriented architectures and software-defined networks for the datacenter in this world region". The Cloud Computing and communications paradigm has defined unprecedented business models, promoting on-demand computing resource allocation, elastic scaling, and elimination of up-front costs. Capitalizing on paradigms such as virtualization, utility computing, grid computing, and service oriented architectures, cloud computing and communications has already changed the way we compute and communicate.

We look forward to seeing you in Maceió!

*Carlos Kamienski and Stenio Fernandes*  
General Co-chairs

# Register for LATIN CLOUD

- **Paper Submission:** Oct. 1st, 2013
- **Acceptance Notification:** Nov. 15th, 2013
- **Final Version:** Nov. 30th, 2013

# IEEE Asia Pacific Cloud Computing Congress

14-17 November 2012 at Shenzhen Wuzhou Guest House



Attendance:  
300



**Peter Staecker presenting Spectrum in Chinese to Vice Mayor Chen Biao of Shenzhen**

KEYNOTE SPEAKERS



**BRANKO BJELAJAC**  
 EXECUTIVE VICE PRESIDENT  
 & CTO, LANDIS+GYR



**LEW TUCKER**  
 VICE PRESIDENT & CTO,  
 CLOUD COMPUTING, CISCO

**IEEE GLOBECOM'13 NEWS**

[REGISTRATION IS NOW OPEN >>](#)

Check out the [Tutorial Program >>](#)

IMPORTANT DATES:

IEEE GLOBECOM 2013: 9-13 December 2013

[IEEE GLOBECOM APPAREL & MERCHANDISE >>](#)

[f Like](#) 293 [t Tweet](#) 29 [Pin it](#)

WELCOME TO ATLANTA



**Register for GLOBECOM**

**CONFERENCE PROGRAM >>**

**MEDIA CENTER >>**

**COMSOC COMMUNITY STORE >>**



**IEEE ComSoc  
 Mentor Program**

# IEEE Cloud Computing Education

Dedicated to serving the education and training needs of members and non-members, the CCI Education Track will develop and offer IEEE's educational programs in cloud computing

Methodology supports:

- eLearning course modules
- Continuing education
- Video of conference presentations, section/chapter talks

# IEEE Cloud Computing Education

Providing a new and comprehensive curriculum through eLearning modules

1. A wider scope of technologies and important topics covered both in cloud Intermediate, Advanced, and Expert, including materials for developers
2. A stronger base on standardization and best practices – right up to expert knowledge at each level, from manager to developer
3. Is intended to achieve level of known certification programs in Cloud Computing
4. Has selected topics and level of coverage based on our experience of what is essential in mastering cloud technologies from initial involvement to current professional work and use of clouds



# Cloud Network Topics

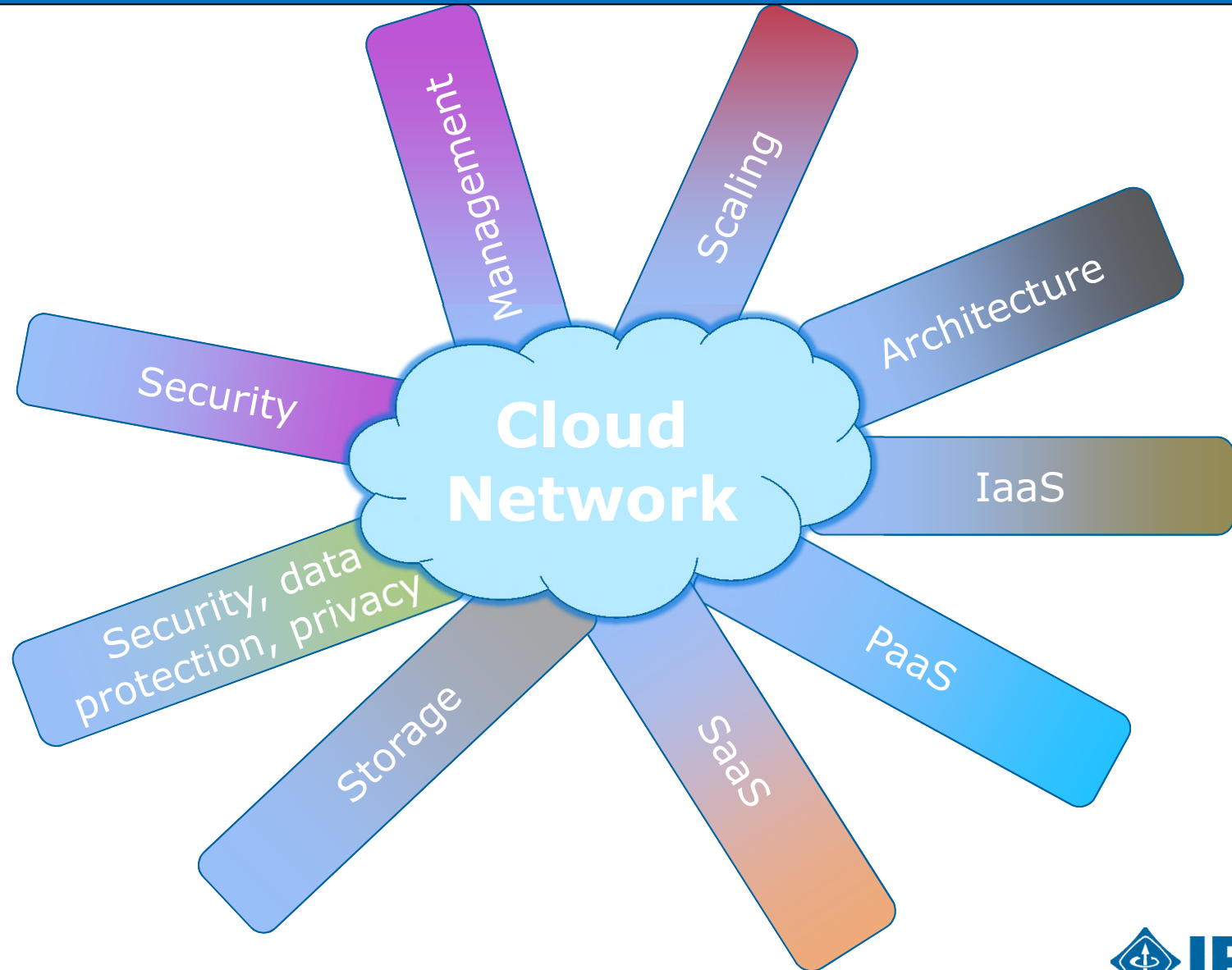

# Sampler of eLearning Modules

Cloud Computing Definition, Reference Architecture, and General Use Cases

Cloud Management Software (platform) (1): OpenStack™, components, tools, configuration examples, design patterns

Cloud Scaling and Cloud Reliability. Cloud Computing Economics: Business and Operational models, Compliance

Cloud Management Software (platform) (2): OpenNebula (detailed overview, design patterns); Eucalyptus overview; VMware vCloud and Cloud Foundry™ (overview)

Servers, Physical Networking, Storage – Design Philosophy Alternatives

Custom and large scale Deployment, Management tools – Chef, Puppet, other tools

Identity and Trust Management in Clouds, Federated Access Control and Resource Management; SLA Management

# IEEE Cloud Computing Publications

Launching several new and very important publications on cloud computing and big data for both expert and lay audiences

- *IEEE Transactions on Cloud Computing*
  - Peer-reviewed engineering journal, call for papers now, launch in 2013
  - Include articles examining innovative research in cloud computing and the results of research in all areas of this broad field
  - Submissions ranging from algorithms and analytics to performance analysis, security and privacy, standards, theory, communications protocols, energy consumption, and applications for business and industry
- *IEEE Cloud Computing Magazine*
  - Broad topics of interest and targeted to the general public, will begin publishing 2014
- IEEE Transactions on Big Data
  - Planning to develop infrastructure and publishing paradigm to publish “big data” sets for access by researchers worldwide
  - Will offer, for example, access to big data being accumulated in research fields such as astronomy, meteorology, genomics, biology, social media, finance

# Prototype Cloud Magazine

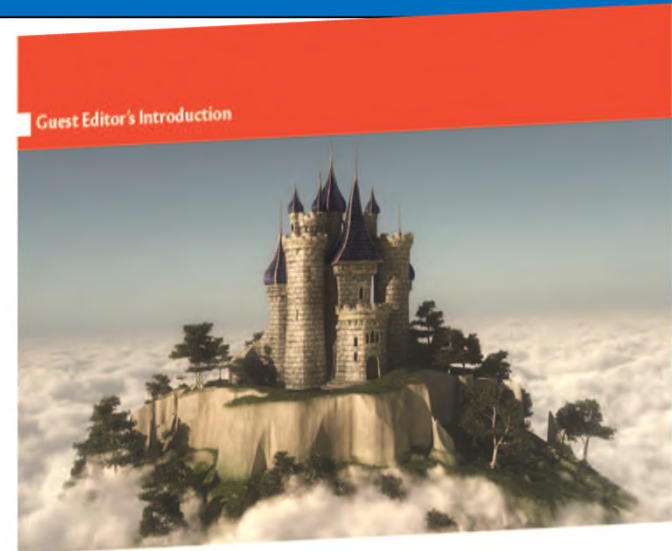
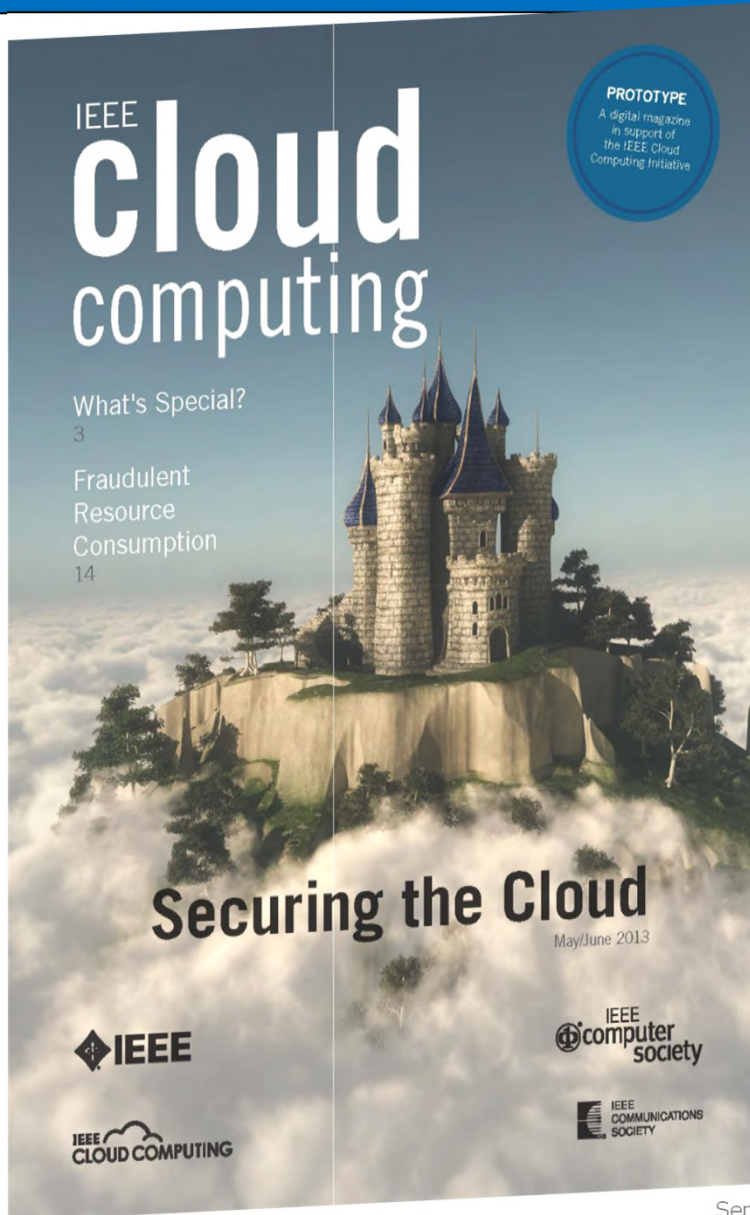

## Cloud Computing: Transforming Information Technology

Jon Rokne • University of Calgary

**T**he migration of information and processes to the cloud is transforming not only where computing is done but, fundamentally, how it is done. Cloud computing solves many conventional computing problems, including handling peak loads, installing software updates, and utilizing excess computing cycles, but the

new technology has also created new challenges in data security, data ownership, transborder data storage, and the training of highly skilled cloud computing professionals. As more in the corporate and academic worlds invest in this technology, IT professionals' working environments are also changing dramatically.

### Taking Initiative

Recognizing that cloud computing is poised to be the dominant form of computing in the future, IEEE has funded a Cloud Computing Initiative (CCI) to coordinate its cloud-related activities. To that end, the IEEE CCI has established tracks for cloud computing standards, conferences, publications, and educational materials. The Cloud Computing Initiative portal site (<http://cloudcomputing.ieee.org>) presents information on all these topics.

The CCI publications track is tasked with developing a slate of cloud computing-related periodicals. To date, it has provided seed funding for two publications: *IEEE Transactions on Cloud Computing*, launched in 2013, and *IEEE Cloud Computing* magazine, which will be available in early 2014. These publications aim to provide a focused home for cloud-related research and feature articles so that cloud researchers can publish their most important work, informing other professionals of new developments in the field.

### In this Issue

To highlight the IEEE CCI's activities and serve as a preliminary announcement of the cloud publications that will

# Call for Papers Transactions on Cloud Computing



## IEEE TRANSACTIONS ON CLOUD COMPUTING

The *IEEE Transactions on Cloud Computing* will publish peer reviewed articles that provide innovative research ideas and applications results in all areas relating to cloud computing. Topics relating to novel theory, algorithms, performance analyses and applications of techniques relating to all areas of cloud computing will be considered for the transactions. The transactions will consider submissions specifically in the areas of cloud security, tradeoffs between privacy and utility of cloud, cloud standards, the architecture of cloud computing, cloud development tools, cloud software, cloud backup and recovery, cloud interoperability, cloud applications management, cloud data analytics, cloud communications protocols, mobile cloud, liability issues for data loss on clouds, data integration on clouds, big data on clouds, cloud education, cloud skill sets, cloud energy consumption, cloud applications in commerce, education and industry. This title will also consider submissions on Infrastructure as a Service (IaaS), Platform as a Service (PaaS), Software as a Service (SaaS), and Business Process as a Service (BPaaS).



### TCC EDITOR-IN-CHIEF

Rajkumar Buyya

*Director, Cloud Computing and Distributed Systems (CLOUDS) Lab, The University of Melbourne*

### TCC Steering Committee Members

#### IEEE COMPUTER SOCIETY

Jon Rokne (SC Chair)  
Tom Conte  
Irena Bojanova  
Dejan Milojicic

#### IEEE COMMUNICATIONS SOCIETY

Vijar Bhargave  
Vincent Chan

#### IEEE SYSTEMS COUNCIL SOCIETY

Paolo Carbone

#### IEEE POWER & ENERGY SOCIETY

Jie Li  
Badrul Chowdhury

#### IEEE CONSUMER ELECTRONICS SOCIETY

Stu Lipoff

For more information please visit: <http://www.computer.org/tcc>



# IEEE Cloud Computing Standards

## IEEE leading the way on Cloud Computing standards:

- IEEE P2301™ Cloud Portability, Commonality
  - Designed to provide an intuitive road map for application portability, management, and interoperability interfaces, as well as for file formats and operating conventions.
- IEEE P2302™ Cloud to Cloud Interoperability
  - Defining the topology, protocols, functionality, and governance required for cloud-to-cloud interoperability.
  - P2302 Working Draft, version 3 distributed
  - Six subgroups responsible for sections of the draft (led by organizations e.g. US Navy SPAWAR, Cisco, Intel etc.)
    - Intercloud Background, Concepts & Topology - Section 4
    - Intercloud Topology Elements - Section 5
    - XMPP based Collaboration Protocol - Sections 6.1 thru 6.5
    - Intercloud Security - Sections 6.6 thru 6.8
    - Ontology Definition - Sections 6.9
    - Decentralized Ontology Deployment - Sections 6.10

# P2302 Standard Development

## New Proposed Contributions:

- Cloud Coordinator (Gateway) and Cloud Exchange Details, *Buyya et al, University of Melbourne*
- Dynamic Trust Establishment Approach for Multi-provider Intercloud, *Demchenko et al, University of Amsterdam*
- CS Numbers for Autonomous Clouds with XMPP-URI-CS format, *Bernstein et al, IEEE*
- Workload Federation and Federated Storage Replication Mechanics, *Bernstein et al, IEEE*

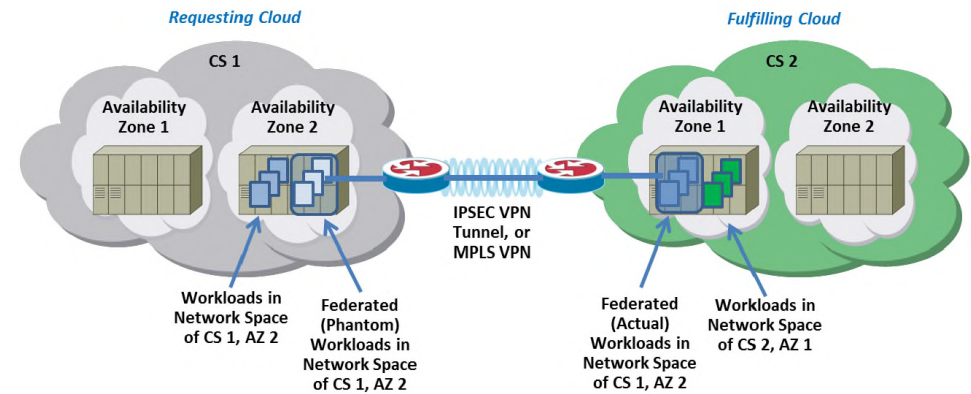
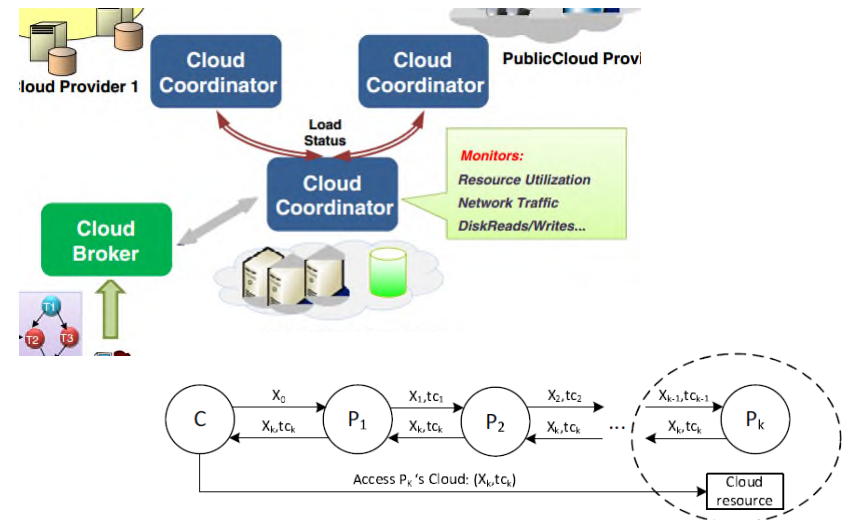

# IEEE Cloud Computing Intercloud Testbed

## Methodology:

- As IEEE P2302 becomes standardized, the cloud computing ecosystem will need a standards-based cloud environment for creating and testing cloud-to-cloud protocols
- Vendors, service providers and application developers will also need a standards-based environment for experimenting with cloud-based products and services
- Executive committee formed
- Several partners secured and we're still open for more partnerships with companies, universities and research institutions around the world who have cloud computing resources to create the intercloud testbed environment



# Intercloud Testbed

Map showing interested parties in the IEEE Intercloud Testbed and their location, including several Telco's

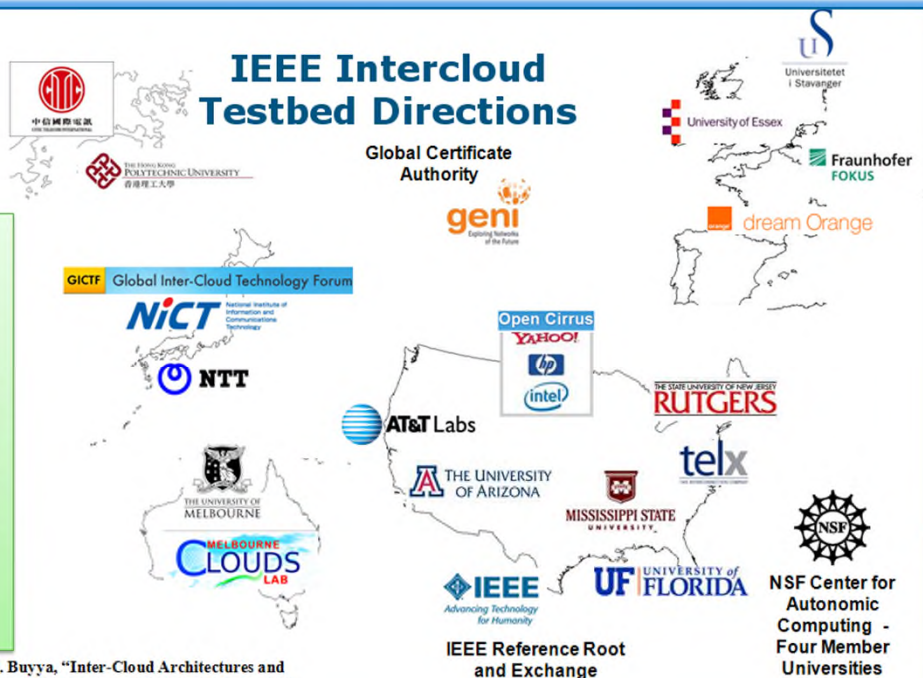

**NOTE:**  
 The P2302 blueprint is a "Transparent Peer to Peer Volunteer" architecture. In contrast to the EGI work, which is an "Independent Multi-Cloud" architecture. \* The SS7/IN PSTN and the Internet are both of type Transparent Peer to Peer Volunteer.

\* N. Grozev and R. Buyya, "Inter-Cloud Architectures and Application Brokering: Taxonomy and Survey", *Journal of Software: Practice and Experience*, Wiley InterScience 2012

Reference Intercloud network topology and elements

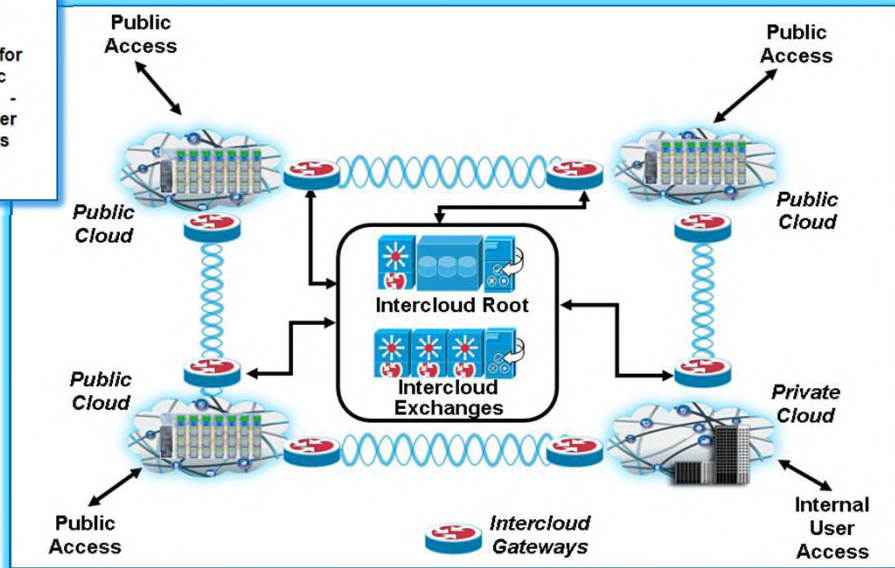

# What is the IEEE Intercloud Testbed Project?

- There are several Open Source and Standards projects in Cloud Computing
- The IEEE is working on an area which no other organization is tackling - that is “Intercloud”
- “Intercloud” is to Clouds as Internet is to Networks; a transparent, volunteer, peer-to-peer federation
- IEEE P2302 Working Group has been drafting a “Standard for Intercloud Interoperability and Federation” with such an architectural approach
- IEEE Intercloud Testbed is a companion effort to prototype, evolve, and make real this work

# Organization of the IEEE Intercloud Testbed Project

- The Testbed is part of the IEEE Cloud Computing Initiative (CCI)
- The Testbed operates as a project of the IEEE “Industry Connections” program
- The Testbed is governed by an Executive Committee, including CCI and elected participant representatives
- The Executive Committee are overseen by the IEEE Cloud Computing Standards Committee (CCSC) and the IEEE-SA Board of Governors (BOG)
- Any company, university, or initiative can join with the approval of a Simple Majority of the EC

# Governance of the IEEE Intercloud Testbed Project

- There is a V 1.0 of the IEEE Intercloud Testbed Industry Connections Activity Policies and Procedures
- This calls for a Six member Executive Committee. Three of these members are participants in the IEEE Cloud Computing Initiative

**Prof. Michael Lightner**  
Chair, Dept. of Electrical and  
Computer Engineering,  
University of Colorado at  
Boulder

**Mark Davis**  
Founder and CTO  
Kitenga, a Dell  
Company

**Prof. Jon Rokne**  
Dept. of Computer  
Science  
The University of Calgary

Three elected Executive Committee members

**Joseph Weinman – Chair**  
SVP, Telx Group, Inc.

**Henry Chan – Vice Chair**  
The Hong Kong  
Polytechnic University  
Department of Computing

**Kun Yang – Secretary**  
University Of Essex

# New Governance Documents

## IEEE Intercloud Testbed Project

- The IEEE Intercloud Testbed Acceptable Use Policy
- Hosting an IEEE Intercloud Test Node

### HOSTING AN IEEE INTERCLOUD TEST NODE

March 2013

THE IEEE INTERCLOUD TESTBED (“the Intercloud Testbed”) is an overlay testbed designed to allow researchers to experiment with cloud computing platforms and services that benefit from distribution across a wide geographic area. All uses of the Testbed should be consistent with this high-level goal.

This “Hosting an IEEE Intercloud Test Node” document is directly derived from “Hosting a PlanetLab Node”.

The Intercloud Testbed is designed to support open research and continuously-running network measurement experiments. In addition to the latter may serve an end-user and services, we expect researchers to use the Testbed for research of network etiquette, as well as for other purposes. A companion document: The Intercloud Testbed Acceptable Use Policy (AUP).

#### Hosting Site Responsibilities

Hosting an IEEE Intercloud Test Node should be consistent with research goals. In particular, hosting a Test Node should:

- Provide IP connectivity for the Test Node, including a public IP address and a DNS name

### THE IEEE INTERCLOUD TESTBED ACCEPTABLE USE POLICY

March 2013

#### BACKGROUND

THE IEEE INTERCLOUD TESTBED (“the Intercloud Testbed”) is an overlay testbed designed to allow researchers to experiment with cloud computing platforms and services that benefit from distribution across a wide geographic area. All uses of the Testbed should be consistent with this high-level goal.

This Acceptable Use Policy (“AUP”) was directly derived from (1) THE NSFNET BACKBONE SERVICES ACCEPTABLE USE POLICY, June 1992, and (2) PlanetLab Acceptable Use Policy, PlanetLab Consortium, February 2004.

#### GENERAL PRINCIPLES:

1. The Intercloud Testbed services are provided to support open research and education in and among Global research and instructional institutions, research arms of for-profit firms, and others when engaged in open scholarly communication and research. Use for other

# Participant Activities

## IEEE Intercloud Testbed Project

- Volunteer to re-use existing datacenter, cloud implementations, or construct a new cloud, of their choice, well-connected in a geography;
- Join the engineering project to code, test, re-engineer, and contribute to an open source implementation of the Intercloud protocol suite;
- Adapt protocols to the various cloud platforms and resource types in use in the Testbed;
- Connect to the reference Intercloud Root and Intercloud Exchange which IEEE are running;
- Explore the overall interoperability and applicability of the NSF GENI Project , in particular the trust and governance mechanisms of the GENI-ABAC project.

# Participant Activities (continued)

## IEEE Intercloud Testbed Project

- Experiment with cloud federation, further develop protocols, formats, and ontologies, explore topology issues for scalability;
- Feed results to the IEEE Standard project;
- Publish Papers on their research and implementation experience to constituencies;
- Create Reference Implementations of:
  - An Intercloud root cloud including naming, messaging, trust, audit, and semantic directory
  - An Intercloud exchange cloud
  - An Operational multi-cloud Intercloud protocol suite
  - Open Source projects of Reference Implementations, perhaps hosted with OpenStack Foundation.

# Liaison Activities

## IEEE Intercloud Testbed Project

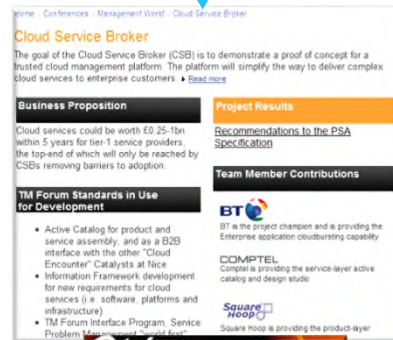
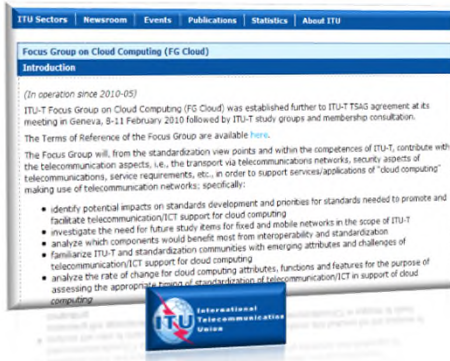
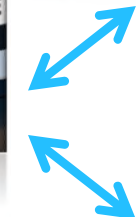
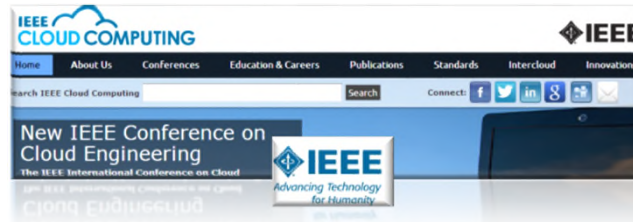



# How we will work

# IEEE Intercloud Testbed Project

Collaboration Site and Wiki  
[cloudcomputing.ieee.org/intercloud](http://cloudcomputing.ieee.org/intercloud)

Conferences

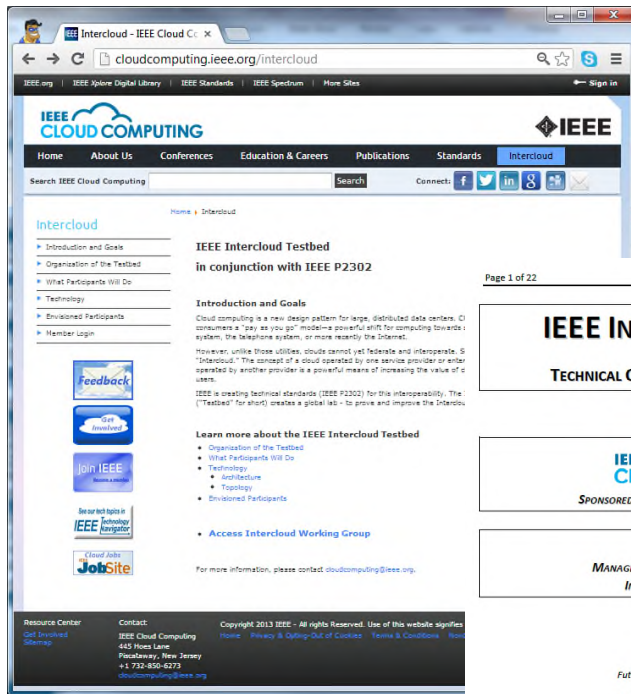

Page 1 of 22 4/11/2013

## IEEE INTERCLOUD TESTBED

TECHNICAL OVERVIEW AND ENGINEERING PLAN



SPONSORED BY THE IEEE CLOUD COMPUTING INITIATIVE



MANAGED BY THE IEEE STANDARDS ASSOCIATION  
INDUSTRY CONNECTIONS PROGRAM

**Supervising Authority:**  
 Kathy L. Grise  
 Future Directions Senior Program Director  
 IEEE Technical Activities  
 445 Hoos Lane, Piscataway, NJ 08854 USA  
[k.l.grise@ieee.org](mailto:k.l.grise@ieee.org)  
[cloudcomputing.ieee.org](http://cloudcomputing.ieee.org)

**Prepared By:**  
 David Bernstein  
 Managing Director  
 Cloud Strategy Partners, LLC, USA  
[david.bernstein@ieee.org](mailto:david.bernstein@ieee.org)  
 Tel 408 857 9872  
[www.cloudstratgeypartners.com](http://www.cloudstratgeypartners.com)

Your  
 Labs!

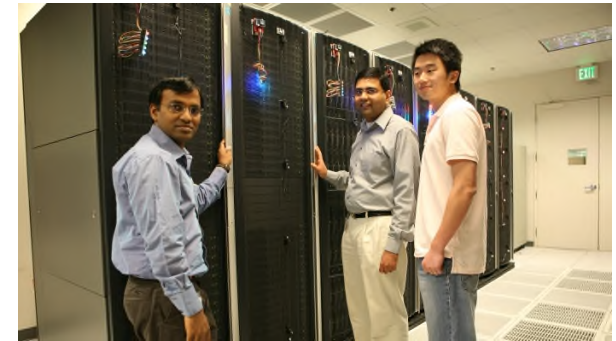

Engineering  
 Plans



# Engineering Plan

## IEEE Intercloud Testbed Project

### Engineering Plan Highlights:

- Topology
- Intercloud Gateway
- Intercloud Roots
  - Naming
  - Communications Substrate
  - Trust Infrastructure
  - Audit Trail
  - Semantic Resource Directory
- Intercloud Exchanges
- Sequence Diagram
- Protocols Summary
- Implementation Use Cases for Consuming Clouds
- Engineering Project Workpackages

Page 1 of 22 4/11/2013

---

### IEEE INTERCLOUD TESTBED

REVIEW AND ENGINEERING PLAN

---



THE IEEE CLOUD COMPUTING INITIATIVE

---



THE IEEE STANDARDS ASSOCIATION  
INDUSTRY CONNECTIONS PROGRAM

---

**Supervising Authority:**  
 Kathy L. Grise  
 IEEE Technical Activities  
 1000 Avenue of the Americas, NJ 08854 USA  
[k.l.grise@ieee.org](mailto:k.l.grise@ieee.org)  
 Tel 732 981 2871  
[cloudcomputing.ieee.org](http://cloudcomputing.ieee.org)

**Prepared By:**  
 David Bernstein  
 Managing Director  
 Cloud Strategy Partners, LLC, USA  
[david.bernstein@ieee.org](mailto:david.bernstein@ieee.org)  
 Tel 408 857 9872,  
[cloudstrategypartners.com](http://cloudstrategypartners.com)

---

IEEE Intercloud TestBed  
 Industry Connections Program – IEEE Cloud Computing Initiative

Page 2 of 22

#### Contents

Background .....	3
Project Motivation .....	4
Importance of the Project to Government, Academia, and Industry .....	4
Organization of the Testbed .....	5
Envisioned Participants .....	5
What Participants will Do .....	6
A Note on the Open Sourcing of Testbed Project Code .....	6
Technical Description .....	6
Topology .....	7
Intercloud Gateway .....	8
Intercloud Roots .....	8
Naming .....	8
Communications Substrate .....	9
Trust Infrastructure .....	9
Audit Trail .....	10
Semantic Resource Directory .....	10
Intercloud Exchanges .....	10
Sequence Diagram .....	11
Protocols Summary .....	12
Implementation Use Cases for Consuming Clouds .....	12
A Consuming Cloud Making Federated Computing look like Its Own .....	12
A Consuming Cloud Making Federated Storage look like Its Own .....	14
Engineering Project Workpackages .....	15
Workpackage: Completion of Master Technical Design Work .....	15
Workpackage: Small Scale Experimental Implementation/Redesign Cycle .....	15
Workpackage: Portable Gateway (Conversational Part) Development .....	16
Workpackage: Portable Gateway (Transport Part) Development .....	16
Workpackage: Portable Gateway (Trust/Security Part) Development .....	16
Workpackage: Open Source Contribution .....	17
Workpackage: Reference Root (Conversational Part) Development .....	17
Workpackage: Reference Root (Transport Part) Development .....	17
Workpackage: Reference Root (Trust/Security Part) Development .....	17
Workpackage: Reference Root (Semantic Directory Part) Development .....	17
Workpackage: Reference Root (Replication Part) Development .....	18
Workpackage: Reference Exchange (Conversational Part) Development .....	18
Workpackage: Reference Exchange (Transport Part) Development .....	18
Workpackage: Reference Exchange (Trust/Security Part) Development .....	19
Workpackage: Reference Exchange (Solver/Arbitrage Part) Development .....	19
Workpackage: Reference Exchange (Replication Part) Development .....	20
Workpackage: Reference Exchange (Audit Part) Development .....	20
Workpackage: SSRP Implementation Attempt .....	20
Workpackage: IEEE 2302 Standard Contribution .....	20
Next Steps .....	20
Appendix 1: Basis of Technology Architecture/Published Research .....	21



# Call for Participation

## IEEE Intercloud Testbed Project

### **Participants, do you have a**

- Cloud Lab,
- Cloud to turn to this effort,
- Place to Host,
- Infrastructure to re-purpose,
- Detailed Design and Specification ability,
- Programmers, Network Engineers,
- Project Management,
- Documentation,
- ?



# IEEE Cloud Computing Web Portal

- Designed as the “go-to” Internet source for authoritative information on cloud computing
- To serve technology experts in cloud computing and others from industry, government, academia, and the general public

[cloudcomputing.ieee.org](http://cloudcomputing.ieee.org)

The screenshot shows the IEEE Cloud Computing Web Portal homepage. At the top, there is a navigation bar with links for Home, About Us, Conferences, Education & Careers, Publications, Standards, and Innovations. Below the navigation bar is a search bar and social media icons. The main content area features a large banner image of a server room with the text "Computing Now" and "Your one-stop source for free, limited-time access to articles from IEEE Computer Society publications." Below the banner, there is a welcome message and a "Technology Spotlight" section with a video player titled "Tech News on IEEE.tv" showing a woman speaking. To the right of the video player is a "Feature Article" section titled "Demand for Standards - Interoperability to Fuel Emergent Cloud Growth." Below the video player is an "Education & Careers" section with the text "Cloud Computing is a wide and dynamic field that is both broad and deep." At the bottom right, there is a "Current Events" section with a list of events, including "11 10th International Cloud Expo" and "13 Cloud Computing World Forum".

# Web Portals, Social Media, Branding

IEEE.org | IEEE Xplore Digital Library | IEEE Standards | IEEE Spectrum | More Sites

**IEEE Cloud Computing for Emerging Markets**  
11-12 October 2012 in Bangalore, India

About Program Registration Author Information Venue/Travel Speakers/Exhibits Patrons

Sponsored by the IEEE Cloud Computing Initiative

Follow: [Facebook] [Twitter] [LinkedIn] [YouTube] | Share: [Email] | SIGN UP FOR EMAIL UPDATES

11-12 October 2012 in Bangalore, India [View All]

**Conference Overview**  
The goal of the IEEE Cloud Computing for Emerging Markets (CEM) conference is to address the unique challenges and opportunities of cloud computing in emerging markets in a high quality event that brings together industry, government, and academic leaders in cloud computing from around the world, particularly from emerging markets.

**Important author information**  
Final paper submissions due now.  
Time to register. Deadline for early discounted registration is 14 September.

Important Dates

## Portal Google Analytics

Over 39,000 visits since portal's launch 25 June 2012  
~122,000 page views  
Over 39,000 unique visitors



>3,600



>1,000 members



Twitter

>1,700 tweets  
>160 following  
> 600 followers

**IEEE CLOUD COMPUTING**

Home About Us Conferences Education & Careers Publications Standards Innovations

Search IEEE Cloud Computing

**IEEE Cloud Computing Congress**  
Co-located with IEEE GLOBECOM 2012, the IEEE North America Cloud Computing Congress will take place on 3-7 December 2012 in Anaheim, California, USA. This event lead by the Cloud Computing Initiative will cover topics on cloud standards, interoperability, big data, and more. [Read more](#)

Welcome to the IEEE Cloud Computing Web Portal, a collaborative source for all things related to IEEE cloud computing. Included are its initiatives on cloud computing, access to articles, conferences, interoperability standards, educational materials, and latest innovations. It also serves as a "portal" to other cloud computing resources throughout the IEEE, and beyond. New announcement: Check out the [press release](#).

**Technology Spotlight**  
Toward an Open Cloud Standard  
Today's cloud ecosystem features several increasingly divergent management interfaces. Numerous bridging

**Feature Article**  
Helping Emerging Markets Soar in the Cloud  
Emerging markets aren't copying the developed world's technological history--often, they're harnessing it. Rather

**In the News**  
IEEE Transactions on Cloud Computing Seeks Editor in Chief  
IEEE Cloud Computing's First Initiative in India  
Free download -- Cutter IT Journal: Cloud Computing Standards  
Middle school using cloud computing for down-to-earth education  
The IEEE's Cloud Computing Initiatives: Chair Steve Diamond explains its aims  
IEEE Brings Cloud Computing Expertise And User Resources Together To Foster Worldw...



# Big Data

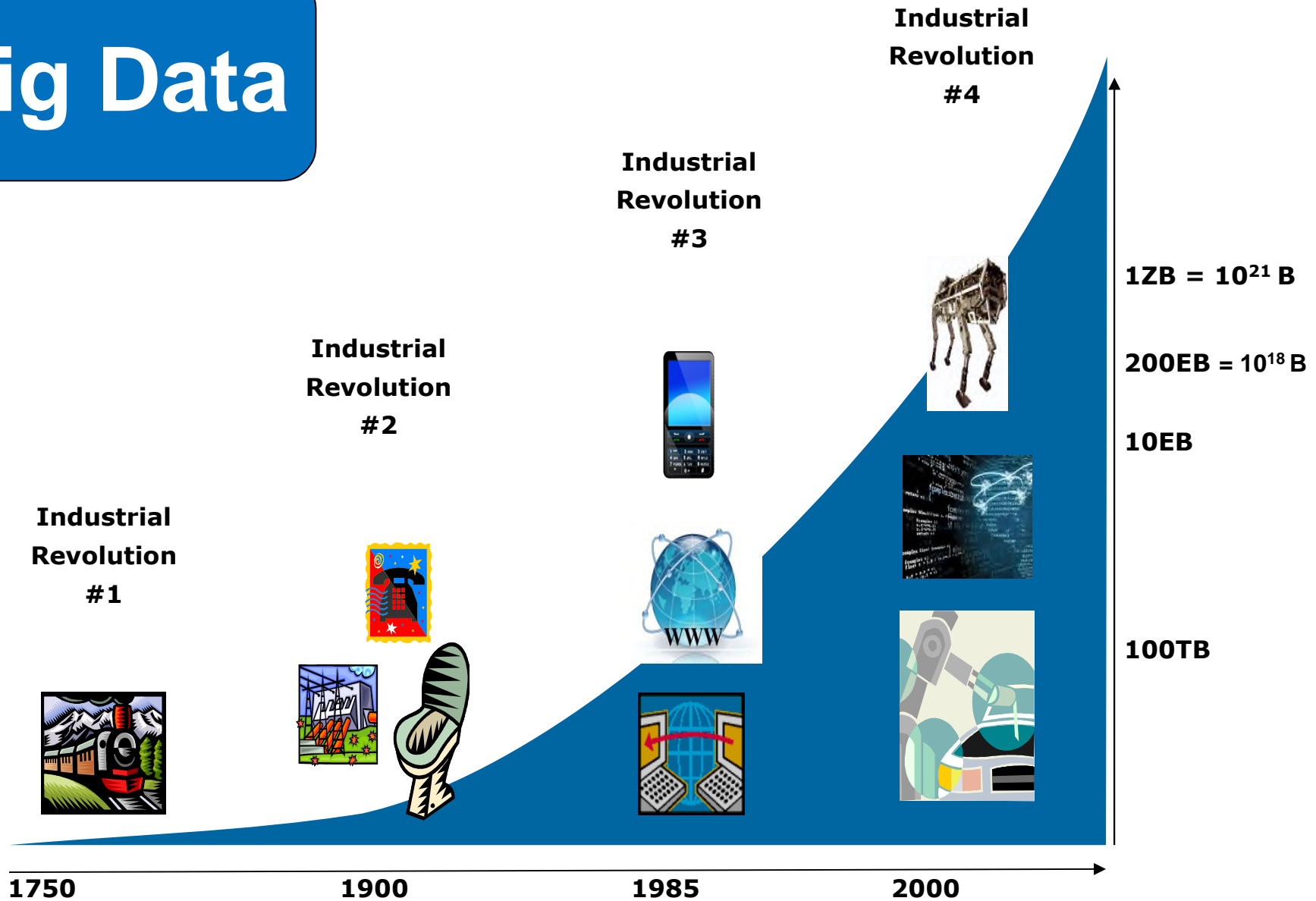

R. J. Gordon: Is US economic growth over? Flailing innovation confronts the six headwinds. CEPR Policy Insight No 63

# IEEE Big Data

Newest track - Area of intense interest and focus  
Working on a new Transactions publication

## Why big data?

- Area of intense interest and focus
- Next-generation compute technologies
- Data-driven future versus theory-driven
- Complexity of data types: structured, semi-structured, and unstructured
- Variety of data sources, use cases, and problems
- Data integration
- Intelligent systems that overcome the brittleness of specification of behavior

# Software Defined Networking (SDN)

## IEEE SDN Initiative

**Mehmet Ulema**, Manhattan College, USA - Contact  
**Nirant Amogh**, Huawei, India

**Raouf Boutaba**, University of Waterloo, Canada

**Cagatay Buyukkoc**, AT&T Labs, USA

**Alex Clemm**, Cisco, USA

**M.Can Vuran**, University of Nebraska-Lincoln, USA

**Linda Xie**, University of North Carolina, Charlotte, USA

**Antonio Mazalini**, Telecom Italia, Italia, Initiative Chair, Working Group

**Bobby Wong** – Initiative Program Director





# A Broader Vision for IEEE

SDN originally perceived to be a “Networking or Transport” specific technology --- can be used in all areas of networks

Broader vision encompasses the whole,  
*Information, Communications, Entertainment Technology (ICET)*

Many existing and future technology goals can be realized using some general principles or characteristics:

*Cognitive Networks, LTE-Adv, Self Organizing Networks, Cloud Computing, Compute & Storage, Smart Grids, Management, Virtualization, etc.*

# Software Defined Ecosystem

Technologies and applications where “Software Defined” concept are applicable to create an ecosystem

- Software Defined
  - Networks (SDN)
  - Service Providers (SDN-SP)
  - Antenna (SD-A)
  - Radio (SD-R)
  - Cloud (SDN-C)
  - Security (SDN-Sec)
  - Data Center (SD-DC)
  - Management (SD-NM)
  - Optical networks (SD-O)
  - Smart Grids (SD-SG)
  - Information Centric Networking (SD-ICN)



**Software  
Defined  
Ecosystem  
(SDE)**

# Key Aspects

- Establish an IEEE wide initiative with a comprehensive program based on a broad vision of SDN
- Prioritized launch of products of services to utilize resources efficiently and to keep up and to lead
- Co-branding as much as possible
- Individual Areas highlights:
  - IEEE Magazine and a Transactions
  - Major conference, regional and topical conferences
  - Standards Committee on SDN to drive standardization
  - Tutorials, eCourses, training courses, webinars
  - Certification programs for people, devices, testbed
  - Web Portal for links to IEEE SDN programs, repository, publicity

# 2013 IEEE workshop on SDN4FNS

## Call for Papers

### 1<sup>st</sup> IEEE Workshop on Software Defined Networks for Future Networks and Services (SDN4FNS) Call for Papers

**Workshop Dates**  
11-13 Nov 2013

**Workshop Location**  
EIT ICT Labs Trento, Italy

#### Important Dates

- **Abstract Registration:**  
02 September 2013
- **Paper Submission:**  
16 September 2013
- **Acceptance notification:**  
10 October 2013
- **Cam-ready submission:**  
25 October 2013

#### Submission Guidelines

Submissions must be original, unpublished work, not under consideration at another conference or journal. Papers must not exceed 6 pages (+1 page for acknowledgements and references) and be formatted in IEEE style

#### Organization Committee

Antonio Manzalini, Roberto Saracco, Ezio Zerbini, David Soldani, Heiner Stüttgen, Stephen F. Bush, Laura Meijere

For details, please visit:  
<http://sites.ieee.org/sdn4fns>

### SDN: A change of paradigm for business or just stuff for techies?

SDN (Software Defined Networks) and NFV (Network Functions Virtualization) are creating the conditions to reinvent network architectures. This is happening first at the edge of the network where "intelligence" has already started migrating, and it is where innovation is more urgently needed to overcome the "ossification" by improving networks and services infrastructure flexibility. It is likely that SDN will impact future networks evolution. SDN principles adoption will allow cost-savings and improvements in the QoS, and even create new business opportunities. It will be a matter of following the thinking that technology and business developments will be more and more strictly intertwined. A certain technology will be adopted not only if it is advantageous and trusted but also if it will be able to enable desired business ecosystems; on the other hand, newly designed potential ecosystems will look for enabling solutions and technologies capable to bring them into reality.

This workshop particularly invites work in early stages aimed at, but not limited to:

- Telco and Internet SDN scenarios (not only seen from the Network Operators' viewpoints but also from the vendors, OTTs and other Players of enterprise networks and consumer electronics viewpoints)
- Hardware and software advances for enabling SDN and NFV
- Management and orchestration, regulatory aspects, Biz models and techno-economic sustainability of SDN.

WIRELESS WORLD  
RESEARCH FORUM™





Future Directions Committee



Technical Program Committee: Albert Vico Oton (Fundació i2CAT), Alex Clemm (Cisco), Alex Gelman (IEEE ComSoc), Andreas Gladisch (DTT-Labs), Çağatay Buflukçoc (AT&T), Dan Pitt (Director of ONF), David Soldani (Huawei), Diego Lopez (TID), Eliezer Dekel (IBM), Ernest Kaempfer (Intel), Erol Gelenbe (Imperial College of London), Ezio Zerbini (Ericsson), Fabian Schneider (NEC Labs Europe), Franco Callegati (University of Bologna), Fulvio Rizzo (Politecnico di Torino), Guido Maier (Politecnico di Milano), Hagen Woerner (BIGDN GmbH), Hans-Martin Foisel (DTAG), Henrik Abramowicz (Ericsson), Linda Xie (U North Carolina), M. Can Vuran (U Nebraska-Lincoln), Marcus Schoeller (NEC Labs Europe), Mehmet Ulema (Manhattan College), Nirant Amough (Huawei), Noel Crespi (Mines Telecom), Prosper Chemouil (Orange Labs), Raouf Boutabaz (U Waterloo), Saverio Niccolini (NEC Labs Europe), Sergio Belier (Huawei), Stefano Secci (UPMC), Wenfu Shen (NTT Network Innovation Labs)

# 2013 IEEE workshop on SDN4FNS

## Conference Website

<a href="#">Home</a>	<a href="#">About</a>	<a href="#">Call for Papers</a>	<a href="#">Registration</a>	<a href="#">Tutorials and Special Sessions</a>	<a href="#">Venue and Travel</a>	<a href="#">Sponsors</a>
Search <input type="text"/> <input type="submit" value="Search"/>						
<b>SDN4FNS in Trento, Italy</b> 		<b>Conference Overview</b> <p>SDN (Software Defined Networks) and NFV (Network Functions Virtualization) are creating the conditions to reinvent network architectures. This is happening first at the edge of the network where "intelligence" has already started migrating, and it is where innovation is more urgently needed to overcome the "ossification" by improving networks and services infrastructure flexibility. It is likely that SDN will impact future networks evolution. SDN principles adoption will allow cost-savings and improvements in the QoS, and even create new business opportunities. It will be a matter of following the thinking that technology and business developments will be more and more strictly intertwined. A certain technology will be adopted not only if it is advantageous and trusted but also if it will be able to enable desired business ecosystems; on the other hand, newly designed potential ecosystems will look for enabling solutions and technologies capable to bring them into reality.</p>		<b>Conference Venue</b> <p><i>SDN4FNS will be held at:</i></p> <p><b>EIT ICT Labs</b></p> <p>EIT ICT Labs Trento, Italy</p> <p>on 11-13 November 2013</p> <p><a href="#">Logistic Information</a></p>		
<b>Theme of the Conference</b> <p><b>Software Defined Networks:</b> A change of paradigm for business or just stuff for techies?</p>		<b>Call for Papers</b> <p><b>SDN4FNS Call for Papers Now Available:</b> For details, please view the <a href="#">Call for Papers</a></p> <p>Paper submission deadline: <b>16 September 2013</b></p> <p>Website for paper submission is now available. Please visit: <a href="http://edas.info/newPaper.php?c=15505">edas.info/newPaper.php?c=15505</a></p>				
<b>Important Dates</b> <p><b>02 September 2013:</b> Abstract submission deadline</p> <p><b>16 September 2013:</b> Papers submission deadline</p> <p><b>10 October 2013:</b> Papers acceptance notification</p> <p><b>18 October 2013:</b> Early registration</p> <p><b>25 October 2013:</b> Papers - final camera ready submission</p> <p><b>11-13 November 2013:</b> 2013 SDN4FNS Conference</p>						
<b>Organizing Committee</b> <p><b>Chair:</b> Antonio Manzalini Roberto Saracco Ezio Zerbini David Soldani Heiner Stuttgen Stephen F. Bush Laura Meijere</p>						
<b>Sponsors</b> 						

# IEEE Cloud Computing – Contact us

Visit the Web Portal:

[cloudcomputing.ieee.org](http://cloudcomputing.ieee.org)



@ieeeccloud



IEEE Cloud Computing



IEEECloudComputing



email: [cloudcomputing@ieee.org](mailto:cloudcomputing@ieee.org)

