

Planar Array Antenna for WPT System at 2.4 GHz

Khanet Pookkapund, Komkris Boonying, Sithichai Dentri, and Chuwong Phongcharoenpanich

Faculty of Engineering, King Mongkut's Institute of Technology Ladkrabang, Bangkok 10520, Thailand

E-mail: net_polo@hotmail.com and kpchuwon@kmitl.ac.th

Abstract - This paper presents a rectifying antenna (rectenna) which can harvest the wireless power at 2.45 GHz band. The proposed antenna is designed to convert the wireless RF signal into DC power. The antenna structure consists of four printed dipoles located perpendicularly to one another to combine the pattern and increase the gain. The compact antenna radiates unidirectional pattern with the high gain. The rectifying circuit part is designed based on voltage diode with stub matching circuit.

Index Terms — Planar Antenna, Rectenna, Rectifying circuit, Wireless power transmission

I. INTRODUCTION

Wireless communications have been used in many applications of daily life. A rectenna is used to obtain the DC power converted from the received RF power [1]. The rectenna consists of an antenna and a rectifier [2]-[3]. The rectifier comprises of four parts namely; a schottky diode, a matching circuit, an output bypass capacitor, and a load resistor [4]. In this paper, there are four printed dipole for receiving the RF power.

II. STRUCTURE

The diagram of the rectenna system consists of four parts. First, the antenna receives the RF signal. Next, the received signal will be converted to DC power by the rectifier circuit. Finally, the DC power will be transferred to the load of the actual applications as shown in figure 1.

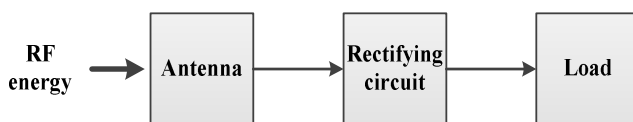

Fig. 1 Diagram of rectenna system.

The antenna structure is composed of a reflector and four printed dipoles located perpendicularly on each side of a square array. The reflector is applied to achieve the unidirectional beam as illustrated in figure 2.

In figure 3, the rectifying circuit of the rectenna consists of the series SMD coupling capacitor connected to the input open stub matching. The schottky diode part number is SMS-7650-006 located between the open stub matching and the SMD filter capacitor. The shunt SMD resistor is used as the load. The antenna parameters are given in table I.

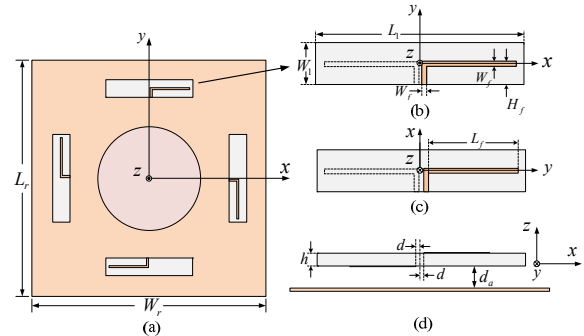

Fig. 2 Geometry and associated dimension of the proposed antenna.

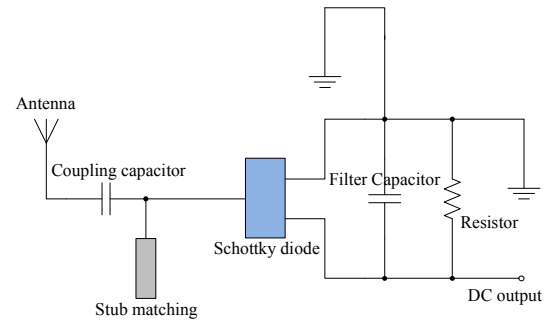
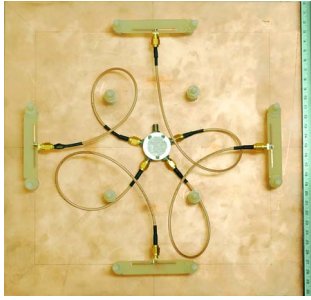

Fig. 3 Schematic of the rectifier circuit.

TABLE I
ANTENNA DESIGNED PARAMETERS

Parameter	Description	Dimension (mm)
W_r	Width of reflector	350.0
L_r	Length of reflector	350.0
W_l	Width of printed structure	10.2
L_l	Length of printed structure	13.0
W_f	Width of strip line	1.5
L_f	Length of strip line	18.0
H_f	Height of strip line	2.2
d	Distance from the center of the antenna to the strip line	0.63
d_a	Distance from the reflector to the printed dipole	16.0
h	Thickness of substrate	1.5

III. SIMULATED AND MEASURED RESULTS



(a) Top view



(b) Perspective view

Fig. 4 The prototype antenna.

The photograph of the prototype antenna is depicted in figure 4. The antenna is fabricated on FR-4 substrate with the dielectric constant of 4.3.

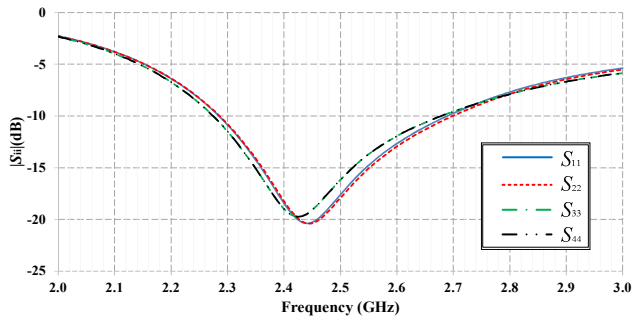
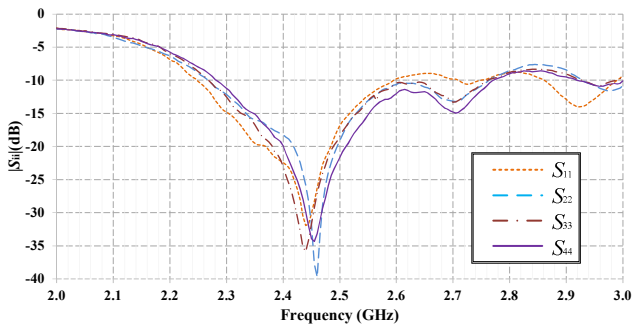
Fig. 5 Simulated $|S_{ii}|$ versus frequency.Fig. 6 Measured $|S_{ii}|$ versus frequency.

The $|S_{11}|$ of each antenna are revealed in figures 5 and 6. The simulated and measured results show $|S_{ii}|$ of less than -10 dB to cover the frequency range of 2.30-2.70 GHz and 2.28-2.60 GHz, respectively.

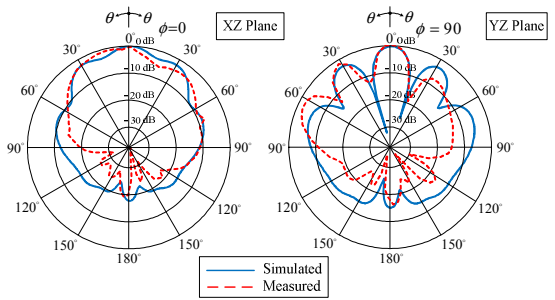

Fig. 7 Radiation pattern in the xz and yz planes at 2.4 GHz.

The proposed antenna radiates the unidirectional beam as illustrated in figure 7. The simulated / measured results of HPBW in xz and yz-planes are $29.5^\circ / 47^\circ$, and $16.4^\circ / 22^\circ$, respectively.

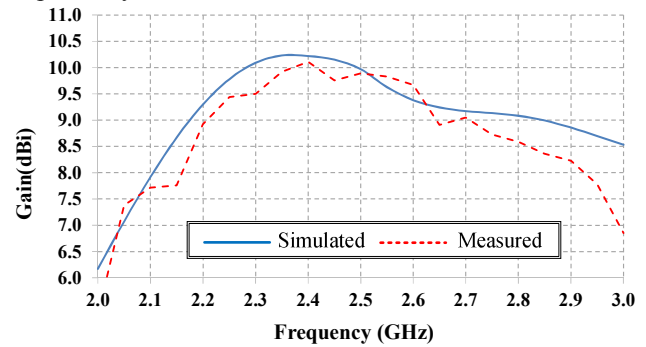

Fig. 8 Simulated and measured gain versus frequency.

The simulated and measured antenna gain is about 10 dBi at the center frequency as shown in figure 8.

V. CONCLUSION

The proposed antenna is designed by using four printed dipole located perpendicularly to form square array. The measured $|S_{ii}|$ is covered from 2.28 to 2.60 GHz. The radiation pattern of the proposed antenna is the unidirectional beam. The antenna gain is around 10 dBi. The rectifying circuits is used to convert the RF power to the DC power. The rectenna efficiency is under investigation.

REFERENCES

- [1] C. K. Chin, Q. Xue, and C. H. Chan, "Design of a 5.8-GHz rectenna incorporating a new patch antenna," *IEEE Antennas and Wireless Propagation Letters*, vol.4, pp.175-178, 2005.
- [2] H. Sun, Y. Guo, M. He, and Z. Zhong, "Design of a high-efficiency 2.45-GHz rectenna for low-input-power energy harvesting," *IEEE Antennas and Wireless Propagation Letters*, vol.11, pp.929-932, 2012.
- [3] T. Q V Hoang, E Séguenot, Fabien ferrero, J-L Dubard, P. Brachat, and J-L Desvilles, "3D voltage pattern measurement of a 2.45 GHz rectenna," *IEEE Transactions on Antennas and Propagation*, vol. 61, no. 6, pp.3354-3356, June 2013.
- [4] J. Zbitou, and M. Latrach, "Hybrid rectenna and monolithic integrated zero-bias microwave rectifier," *IEEE Transactions on Microwave Theory and Techniques*, vol.54, no.1, pp.147-152, Jan. 2006.