

# Effect of Calibration for Wideband Impedance Measurement Using the S-Parameter Method

#Shohei Konya, Takayuki Sasamori, Teruo Tobana, and Yoji Isota

Faculty of Systems Science and Technology, Akita Prefectural University

84-4, Ebinokuchi, Yurihonjo, Akita 015-0055, Japan. E-mail: m12b010@akita-pu.ac.jp

## Abstract

Recently, a measurement technique called the S-parameter method using a standard vector network analyzer has been proposed, whereby the input impedance of a balanced fed antenna can be found. In this paper, the open-short-correction method is adopted to compensate for the influence of the jig used in the S-parameter method.

**Keywords:** S-parameter method Input impedance Dipole antenna

## 1. Introduction

In recent years, the use of wireless telecommunication services has become widespread worldwide. It is known that the characteristics of conventional antennas, such as monopole antennas, change considerably when the handset is touched by a hand. This is caused by the variation of the current on the surface of the conducting box used for the handset due to the influence of the human body. To decrease the influence of the human body, a balanced fed antenna has been suggested [1]. The input impedance of the balanced antenna is measured conventionally using a balun that forces opposite currents into each part of the radiation element. Therefore, the measured result of the input impedance of the balanced antenna includes the influence of the balun. On the other hand, an S-parameter method has been suggested for measuring the balanced impedance of the antenna using a jig instead of the balun, and two ports of a vector network analyzer (VNA) [2], [3]. The S-parameter method was used to measure the input impedance of RF-ID tag antennas for the frequency band of 500-1500 MHz [4].

In this paper, an open-short-correction method is applied to eliminate the influence of the jig for the S-parameter method. The results of the S-parameter method with and without the open-short-correction are presented for a dipole antenna, which is one of the commonly used balanced fed antennas. The effect of the open-short-correction is examined by comparing it with the measured result of a monopole antenna on a ground plane and the calculated result using the method of moments (MoM) for the dipole antenna.

## 2. S-parameter Method

Figure 1 shows the dipole antenna, which is one of the balanced fed antennas. Using the two-port network as shown in Figure 2, the equation using the impedance matrix for the dipole antenna is given by

$$\left. \begin{aligned} V_1 &= z_{11}I_1 + z_{12}I_2 \\ V_2 &= z_{21}I_1 + z_{22}I_2 \end{aligned} \right\} \quad (1)$$

When the dipole antenna is fed by a balanced source, the currents that flow in the two radiation elements are  $I = I_1 = -I_2$ . Because the differential voltage is  $V_d = V_1 - V_2$ , the input impedance  $Z_{in}$  is expressed as follows.

$$Z_{in} = V_d / I = z_{11} - z_{12} - z_{21} + z_{22} \quad (2)$$

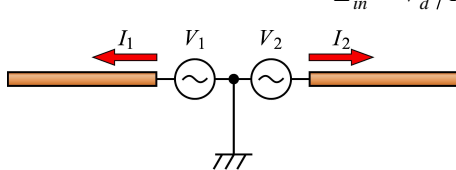

Figure 1: Dipole antenna.

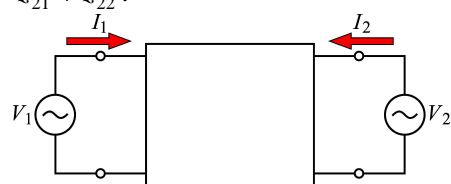

Figure 2: Two-port network.

### 3. Measurement Method

#### 3.1 Structure of the Jig

Figure 3 shows the jig used in this study for measurement using the S-parameter method. The jig is made up of two RG405 semi-rigid cables. The cable is connected with an SMA connector at one end, while the other end has its inner conductor exposed. The jig is then formed by soldering the outer sleeves of the two cables together, as shown in Figure 3. As shown in Figure 4, the connectors of the jig are connected to the cable, and the exposed inner conductors of the jig are soldered to the radiation elements of the dipole antenna. In this study, the jigs connected to port 1 and port 2 are called jig #1 and jig #2. Two semi-rigid cables with lengths almost the same as jigs #1 and #2 are exchanged for the jigs before the antenna elements are installed, and a SOLT calibration is employed at the end of the coaxial cable.

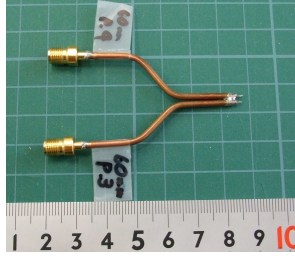

Figure 3: Jig for measuring.

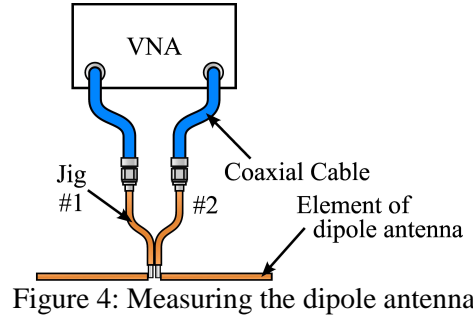

Figure 4: Measuring the dipole antenna.

#### 3.2 Calibration of the Influence of the Jig

Figure 5 shows the circuit diagram with an antenna connected to the jig for measurement in a two-port network configuration. In this paper, the cascade matrix  $K$  of the antenna is obtained by removing the cascade matrices of the jigs  $K_{J1}$  and  $K_{J2}$  from the cascade matrix  $K'$  that is between the calibration planes. The matrix  $K'$  can be determined by substituting the measured results of the S parameters at the calibration planes using a VNA in Equation (3).

$$K' = \begin{bmatrix} \frac{(1 + s_{11})(1 - s_{22}) + s_{12}s_{21}}{2s_{21}} & \frac{(1 + s_{11})(1 + s_{22}) - s_{12}s_{21}}{2s_{21}} \\ \frac{(1 - s_{11})(1 - s_{22}) - s_{12}s_{21}}{2s_{21}} & \frac{(1 - s_{11})(1 + s_{22}) + s_{12}s_{21}}{2s_{21}} \end{bmatrix}. \quad (3)$$

Therefore, the matrix  $K$  of the antenna is determined from Equation (4) using  $K_{J1}$  and  $K_{J2}$ .

$$K = K_{J1}^{-1} K' K_{J2}^{-1}. \quad (4)$$

Consequently, the input impedance  $Z_{in}$  can be expressed as follows, by converting Equation (2) into the cascade matrix:

$$Z_{in} = \frac{A + D + BC - AD - 1}{C}. \quad (5)$$

In the next section, we explain a method for determining the cascade matrices  $K_{J1}$  and  $K_{J2}$ .

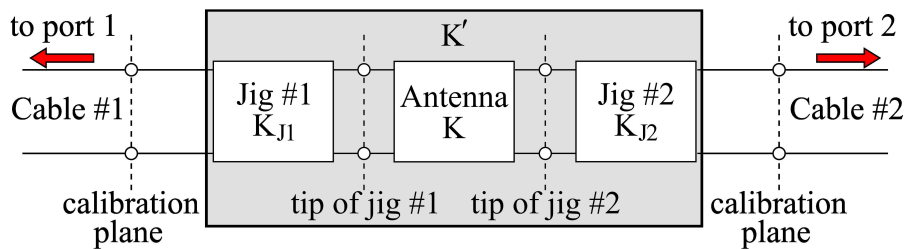

Figure 5: Equivalent circuit schematic of the antenna with the measuring jig.

### 3.3 Open-short-correction

Open-short-correction is a method for determining the cascade matrices  $K_{J1}$  and  $K_{J2}$  using the input impedance when the jig is terminated in an open and a short circuit. The equivalent circuit of the jigs is supposed to be an L-network, as shown in Figure 6. When the end of the jig is short-circuited, the corresponding input impedance is  $Z_{1S}$ . When the end of the jig is open-circuited, the corresponding input impedance is  $Z_{1O}$ . For jig #1, the Z-matrix of the L-network is expressed as follows:

$$Z_{J1} = \begin{bmatrix} Z_{1S} + Z_{1O} & Z_{1O} \\ Z_{1O} & Z_{1O} \end{bmatrix}. \quad (6)$$

When this equation is converted into a cascade matrix, we obtain (7):

$$K_{J1} = \begin{bmatrix} (Z_{1S} + Z_{1O})/Z_{1O} & Z_{1S} \\ 1/Z_{1O} & 1 \end{bmatrix}. \quad (7)$$

Similarly, the cascade matrix  $K_{J2}$  for the jig #2 can be obtained as  $K_{J1}$ .

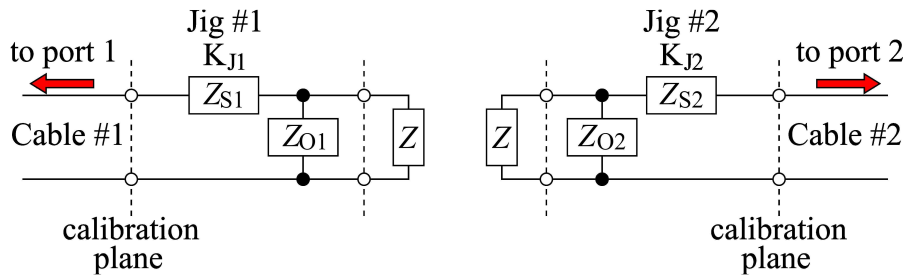

Figure 6: Circuit diagram of open-short-correction.

## 4. Measurement Results

Typical results for the S-parameter method are presented for a dipole antenna. Two pieces of copper wire, each 98 mm long and 0.35 mm diameter, were soldered onto the center conductors of jigs #1 and #2 creating the dipole to be measured. To confirm the accuracy of the measurement results for the S-parameter method, the dipole antenna was also measured in the conventional manner where a ground plane and the method of images used only one element of the dipole. An aluminum plate of 1.25 m × 1.25 m was used for the ground plate. The measured input impedance of the monopole antenna was then multiplied by two to find the differential input impedance of the dipole antenna. In addition, the calculation results using the MoM and the measured results without the open-short-correction are also shown.

Figure 8(a) and (b) show the real and imaginary parts of the input impedance of the dipole antenna. It was confirmed that the measured result of the monopole antenna was in excellent agreement with the calculated result. Therefore, it is understood that these values are appropriate as the standard for comparison. It can be seen that the frequencies of the peak of the S-parameter method without the open-short-correction deviate from the standard value as shown in Figure 8(a) and (b). This is due to the influence of the jig. On the other hand, the results of the S-parameter method calibrated by the open-short-correction agree quite well with the results of the monopole antenna and MoM. It is shown that there are discrepancies between the calibrated S-parameter method and the standard value at anti-resonance frequencies of 1.3 GHz and 2.8 GHz, and at frequencies greater than about 10 GHz. Note that the discrepancy at the anti-resonance frequency is due to the error of the high-resistance measurements by the VNA of the 50 Ω system.

To verify the result from a different viewpoint, the amplitude and phase of the input impedance of the same dipole antenna are shown in Figure 9(a) and (b). It is also obvious that the amplitude of the input impedance for the calibrated S-parameter method has errors at peak frequencies and at frequencies greater than about 10 GHz. On the other hand, the phase is in good agreement over the whole frequency range. Therefore, decreasing the amplitude errors at frequencies greater than about 10 GHz remains to be solved.

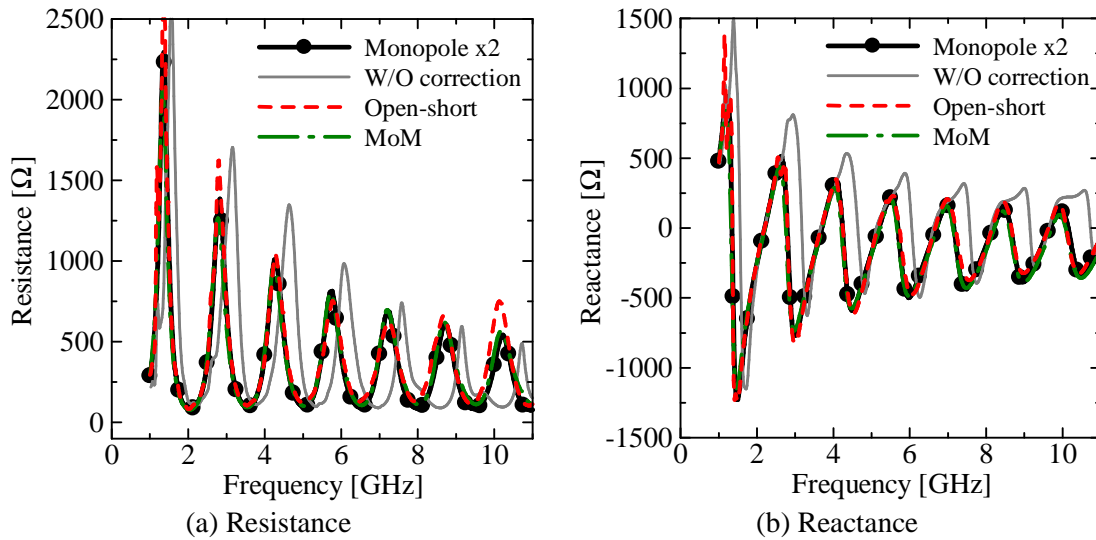

Figure 8: Input impedance of the dipole antenna.

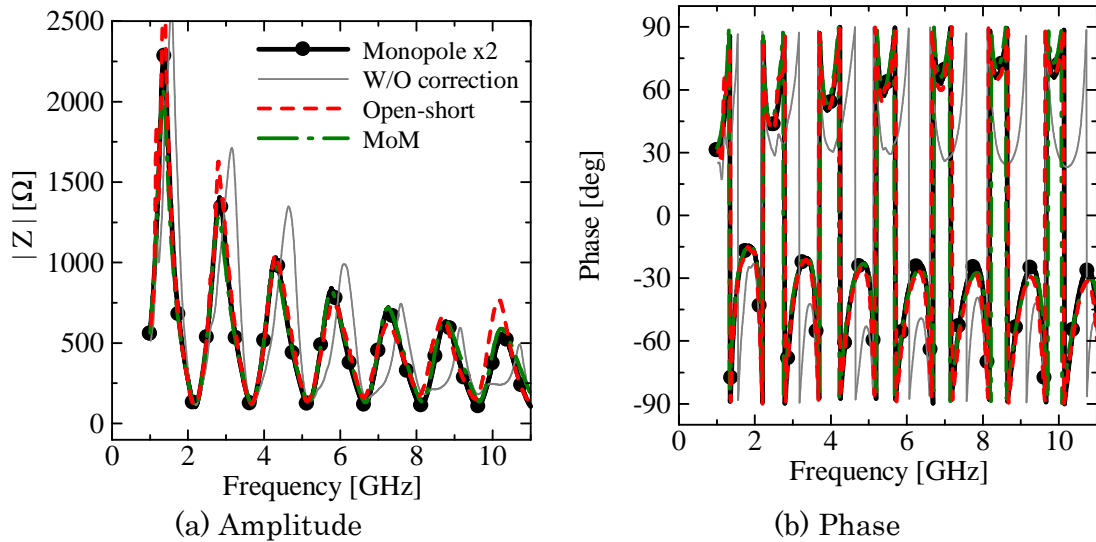

Figure 9: Input impedance of the dipole antenna.

## 5. Conclusions

In this paper, the open-short-correction method has been adopted to compensate for the influence of a jig used in the S-parameter method. The effect of the open-short-correction was examined by comparing it with the measured result of a monopole antenna on a ground plane and the calculated result using the MoM for the dipole antenna. It was found that the result of the S-parameter method calibrated by the open-short-correction method agreed well with the measured result of the monopole antenna and the calculated result using the MoM for frequencies lower than about 10 GHz.

## References

- [1] H. Morishita, Y. Kim, K. Fujimoto, "Design concept of antenna for small mobile terminals and the future perspective," *IEEE Transactions on Antennas and Propagation*, vol. 44, no. 5, pp. 30-42, 2002.
- [2] R. Meys, and F. Janssens, "Measuring the impedance of balanced antennas by an S-parameter method," *IEEE Antennas Propag. Mag.*, Vol. 40, No. 6, pp. 62-65, Dec. 1998.
- [3] K. D. Palmer, and M. W. van Rooyen, "Simple broadband measurements of balanced loads using a network analyzer," *IEEE Trans. Instrum. Meas.*, Vol. 55, No. 1, pp. 266-272, Feb. 2006.
- [4] X. Qing, C. K. Goh, and Z. N. Chen, "Impedance Characterization of RFID Tag Antennas and Application in Tag Co-Design," *IEEE Trans. MTT*, Vol. 57, No. 5, pp.1268-1274, May 2009.