

Synchronization Phenomena of Chaotic Circuits with Stochastically-Changed Network Topology

Toshiaki Nishiumi[†], Yoko Uwate[†] and Yoshifumi Nishio[†]

[†]Department of Electrical and Electronic Engineering, Tokushima University
 2-1 Minamijosanjima, Tokushima, 770-8506, Japan
 Email: {nishiumi, uwate, nishio}@ee.tokushima-u.ac.jp

Abstract—In this study, we investigate the synchronization phenomena observed from five chaotic circuits with stochastically coupling. First, we research the synchronization state changing network topology. For the simulation, we focus on synchronization ratio with various coupling topologies. Furthermore, we propose several coupling rules and investigate the synchronization by the influence of the coupling rules.

1. Introduction

Synchronization phenomena is one of the basic nonlinear phenomena and it can be observed everywhere in our living life [1]-[4]. For example, vibration of the cells of the human and begins to croak at the same time of the frog. Recently, in particular, synchronization phenomena in coupled chaotic circuits are attracted many researchers attentions. There are many real physical phenomena exhibiting by coupled chaotic circuits, and it is important to investigate synchronization phenomena observed from coupled chaotic circuits for future engineering applications. We consider that there are many real physical phenomena exhibiting by coupled chaotic circuits, and it is important to investigate synchronization phenomena observed from coupled chaotic circuits for future engineering applications.

In this study, we investigate the relationships between network connection and synchronization phenomena. First, we research network topology when the coupling probability is changed. Second, we confirm basic synchronization. Finally, we focus on the synchronization ratio of various combination coupled chaotic circuits. Furthermore, we compare the ratio of synchronization when rules of combination coupling are applied.

2. Circuit Model

2.1. Nishio-Inaba Chaotic Circuit

Figure 1 shows the model of the used chaotic circuit called Nishio-Inaba circuit.

The circuit consists of a negative resistance, a nonlinear resistance consisting of two diodes, a capacitor and two inductors. The following equation describes the approximated I-V characteristic of the nonlinear resistance, where

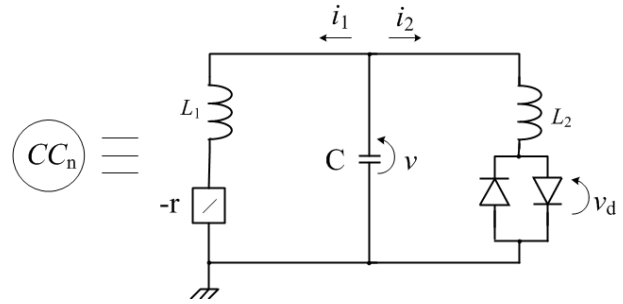

Figure 1: Nishio-Inaba Chaotic Circuit.

the parameter r_d is the slope of the nonlinear resistance.

$$v_d(i_2) = \frac{r_d}{2} (|i_2 + \frac{V}{r_d}| - |i_2 - \frac{V}{r_d}|). \quad (1)$$

The circuit dynamics is then described by the following piecewise-linear third-order ordinary differential equation:

$$\begin{aligned} L_1 \frac{di_1}{dt} &= v + ri_1 \\ L_1 \frac{di_2}{dt} &= v - v_d(i_2) \\ C \frac{dv}{dt} &= -i_1 - i_2. \end{aligned} \quad (2)$$

Equation (2) can be normalized by changing the variables according to

$$i_1 = \sqrt{\frac{C}{L_1}} Vx; \quad i_2 = \frac{\sqrt{L_1 C}}{L_2} Vy; \quad v = Vz;$$

$$\alpha = r \sqrt{\frac{C}{L_1}}; \quad \beta = \frac{L_1}{L_2} \delta = r_d \frac{\sqrt{L_1 C}}{L_2}; \quad t = \sqrt{L_1 C} \tau.$$

yielding

$$\begin{aligned} \dot{x} &= \alpha x_i + z_i \\ \dot{y} &= z - f(y) \\ \dot{z} &= -x_i - \beta y_i - \beta y \end{aligned} \quad (3)$$

where $f(y)$ is described as follows:

$$f(y) = \frac{\delta}{2}(|y + \frac{1}{\delta}| - |y - \frac{1}{\delta}|). \quad (4)$$

Next, we consider the following equations when each chaotic circuit is coupled.

$$\begin{aligned} \dot{x} &= \alpha x_i + z_i \\ \dot{y} &= z_i - f(y) \\ \dot{z} &= -x_i - \beta y_i - \gamma_{ij} \sum_{j=1}^n (z_i - z_j) \end{aligned} \quad (5)$$

$(i, j = 1, 2, \dots, n)$

where i in the equation represents the circuit itself, and j indicates the coupling with other circuits. The parameter γ_{ij} represents the coupling strength between the circuits.

2.2. Proposed Model

Figure 2 shows the circuit model used in this study. Each circuit is connected by a resistor. Also, coupled state (coupling or uncoupling) is determined by stochastically one by one. We define the uncoupling probability ($= p$) in the coupled chaotic circuits. For example, when if the uncoupling probability is set to $p = 80\%$, the state of coupling and the phase difference become like Fig. 3(a) and (b). For this simulation, we change the network topology one hundred times when the uncoupling probability p is changed from 0% to 100%.

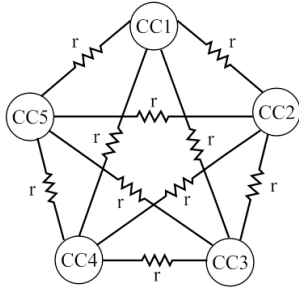

Figure 2: Circuit model ($n = 5$).

2.3. Synchronization Ratio

In this study, we research synchronization ratio with range from $p = 0\%$ to $p = 100\%$. In order to analyze synchronization ratio, we define the synchronization as following equation:

$$|z_M - z_N| < 0.1. \quad (M, N = 1, 2, \dots, 5) \quad (6)$$

where M is the number of circuits and N is circuit which connected circuit M .

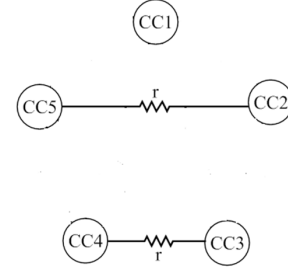

(a) Coupling state ($p = 80\%$).

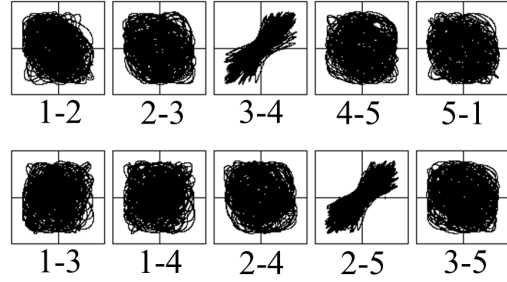

(b) Phase different ($p = 80\%$).

Figure 3: Simulation results ($p = 80\%$).

3. Synchronization Phenomena

3.1. Basic Synchronization

In this section, we confirm the synchronization ratio when network topology is changed at every $\tau=100, 1500$. When τ is 1500, the synchronization just settle down in synchronous or asynchronous. Figure 4 shows the simulation result of the synchronization ratio. The horizontal axis is an indicator of the uncoupling probability. The vertical axis is an indicator of the synchronization ratio of average when the network topology is changed one hundred times every parameter p . From the result, the ratio of asynchronous increases with the uncoupling probability. Then, there is similar result as far as 30% for 100%. However, there is different result as far as 30% for 100%. Namely, if the network topology is changed before the synchronization just settle down in synchronous or asynchronous, The ratio of synchronization predisposition toward asynchronous.

3.2. Synchronization Phenomena is Based on Rule of Combination Coupling

In this section, we focus on synchronization phenomena with combination coupling. Now, we define three rules depending on combination coupling. We call their rules rule A, rule B and rule C. Table 1(a) and (b) show the corresponded coupling rule A and B. For example rule A, if CC1 - CC2 determines uncoupling, CC2 - CC5 is surely uncoupling. In the case of rule B, if CC1 - CC2 determines uncoupling,

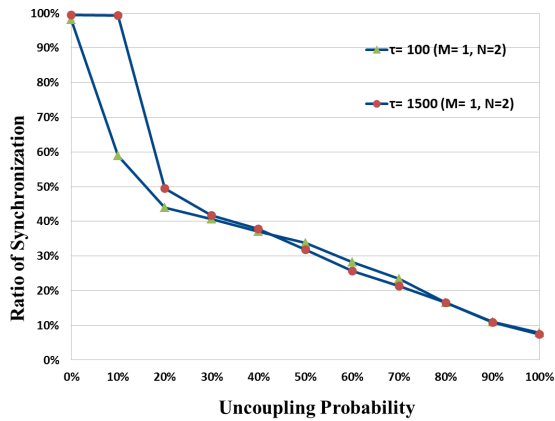

Figure 4: Simulation result (Basic synchronization).

pling, CC2 - CC3, CC3 - CC4, CC4 - CC5 and CC5 - CC1 are surely uncoupling. In the case of rule C, if any coupling is determined uncoupling, every other couplings is surely uncoupling. Then, we investigate the synchronization ratio with changing network topology one hundred times when the network topology is changed at every $\tau = 1500$. Figure 5 shows the simulation result. From the result, we obtain a different result when chaos synchronization is based on rule of combination coupling. Namely, the number of corresponding coupling is larger, the synchronization ratio tends to high proportion.

In order to obtain details of the Fig. 5, we investigate the synchronization ratio when the network topology is changed several times. Figures 6(a) and 7 show the synchronization ratio when the network topology is changed ten times. Also, Figure 6(b) shows the coupling state corresponded Fig. 6(a). From the result, synchronization ratio is wildly different depending on coupling or uncoupling. In addition to that, there are different result even if there are same number of couplings.

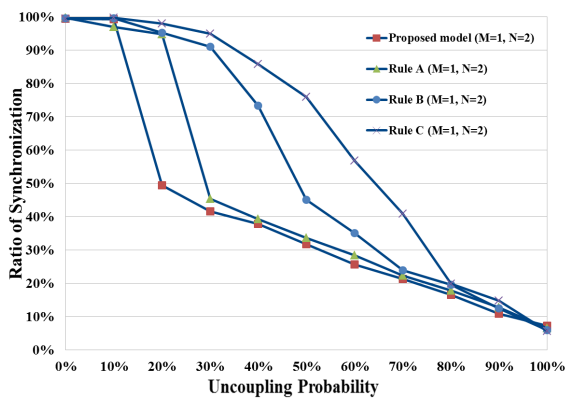

Figure 5: Simulation result (Synchronization phenomena is based on rule of combination coupling).

Table 1: Uncoupling combination.

CC1-CC2 \Leftrightarrow CC2-CC5
CC2-CC3 \Leftrightarrow CC3-CC1
CC3-CC4 \Leftrightarrow CC4-CC2
CC4-CC5 \Leftrightarrow CC5-CC3
CC5-CC1 \Leftrightarrow CC1-CC4

(a) Uncoupling combination (Rule A).

CC1-CC2 \Leftrightarrow CC2-CC3, CC3-CC4, CC4-CC5, CC5-CC1
CC2-CC3 \Leftrightarrow CC1-CC2, CC3-CC4, CC4-CC5, CC5-CC1
CC3-CC4 \Leftrightarrow CC1-CC2, CC2-CC3, CC4-CC5, CC5-CC1
CC4-CC5 \Leftrightarrow CC1-CC2, CC2-CC3, CC3-CC4, CC5-CC1
CC5-CC1 \Leftrightarrow CC1-CC2, CC2-CC3, CC3-CC4, CC4-CC5
CC1-CC3 \Leftrightarrow CC2-CC4, CC3-CC5, CC4-CC1, CC5-CC2
CC2-CC4 \Leftrightarrow CC1-CC3, CC3-CC5, CC4-CC1, CC5-CC2
CC3-CC5 \Leftrightarrow CC1-CC3, CC2-CC4, CC4-CC1, CC5-CC2
CC4-CC1 \Leftrightarrow CC1-CC3, CC2-CC4, CC3-CC5, CC5-CC2
CC5-CC2 \Leftrightarrow CC1-CC3, CC2-CC4, CC3-CC5, CC4-CC1

(b) Uncoupling combination (Rule B).

4. Conclusions

In this study, we investigate the chaos synchronization in stochastic system with various coupling topologies. For this investigation, we observe the difference in synchronization ratio with various coupled chaotic circuits. By using the computer simulations, we have observed the interesting synchronization phenomena.

In the future work, we would like to examine more complex networks. Additionally, we would like to investigate the mechanism of observed synchronization phenomena in detail.

References

- [1] N.F. Rullckov and M.M. Sushchik, "Robustness of Synchronized Chaotic Oscillations," *Int. J. Bifurcation and Chaos*, vol. 7, no. 3, pp. 625-643, 1997.
- [2] M. Wada, Y. Nishio and A. Ushida, "Analysis of Bifurcation Phenomena in Two Chaotic Circuits Coupled by an Inductor," *IEICE Trans. Fundamentals*, vol. E80-A, no. 5, pp. 869-875, 1997.
- [3] Y. Nishio and A. Ushida, "Chaotic Wandering and its Analysis in Simple Coupled Chaotic Circuits," *IEICE Trans. Fundamentals*, vol. E85-A, no. 1, pp. 248-255, 2002.
- [4] G. Abramson, V.M. Kenkre and A.R. Bishop, "Analytic Solutions for Nonlinear Waves in Coupled Reacting Systems," *Physica A*: vol. 305, no. 3-4, pp. 427-436, 2002.

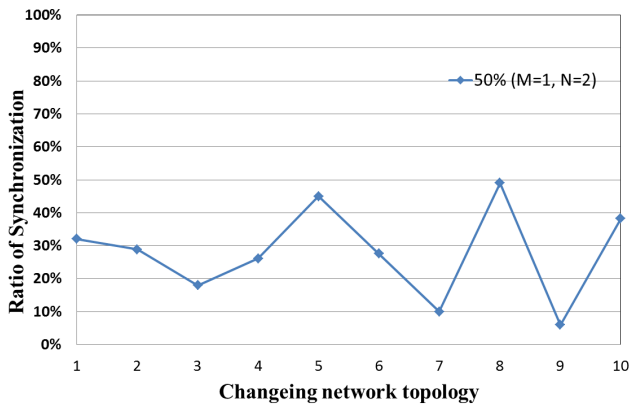

(a) Ratio of synchronization (Pattern A, 50%).

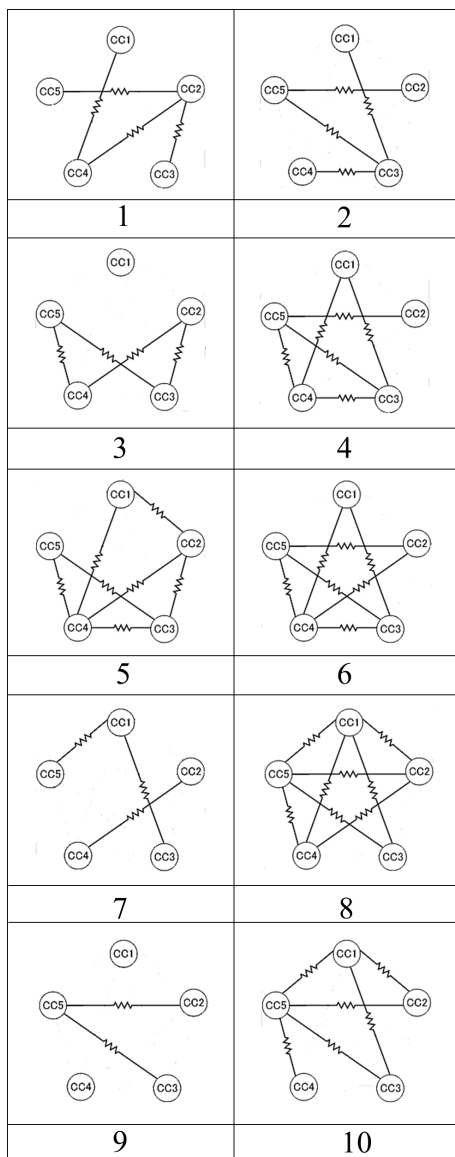

(b) State of topology (Pattern A, 50%).

Figure 6: Ratio of synchronization (Pattern A, 50%).

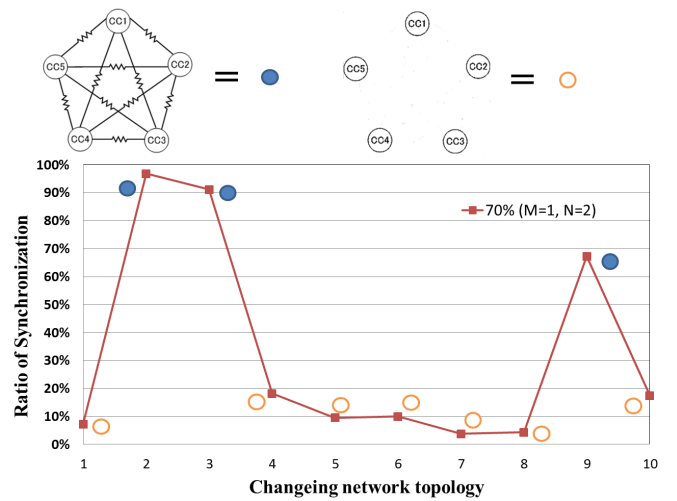

Figure 7: Ratio of synchronization (Pattern C, 70%).