

## Circuit Experiments for Bifurcation of Time Waveforms on Forced LED Fireflies

Kyosuke Miyamoto<sup>†</sup>, Daisuke Ito<sup>††</sup>, Hiroyuki Asahara<sup>†††</sup>,  
Takuji Kousaka<sup>‡</sup>, Tetsushi Ueta<sup>‡‡</sup> and Hiroshi Kawakami<sup>‡‡‡</sup>

<sup>†</sup>Advanced technology and Science Systems, Tokushima University, Tokushima, JAPAN

<sup>††</sup>Department of Electronic System, The University of Shiga Prefecture, Shiga, JAPAN

<sup>†††</sup>Electrical and Electronic Systems Department, Okayama University of Science, Okayama, JAPAN

<sup>‡</sup>Mechanical and Energy Systems Engineering, Oita University, Oita, JAPAN

<sup>‡‡</sup>Center for Admin. Info. Tech., Tokushima University, Tokushima, JAPAN

<sup>‡‡‡</sup>Professor emeritus, Tokushima University, Tokushima, JAPAN

Email: c501537037@tokushima-u.ac.jp, ito.d@e.usp.ac.jp, asahara@ee.ous.ac.jp,  
takuji@oita-u.ac.jp, ueta@tokushima-u.ac.jp, h.kawakami@384.jp

**Abstract**—Creatures with rhythm phenomenon is shown mutual emphasis and combination, this is called synchronization phenomenon that is one of typical phenomenon in nonlinear systems. As the example of creatures causing synchronization phenomenon, there are group emissions of light of fireflies and chorus of crickets [1] [2] [3]. In this paper, we observe bifurcation phenomenon of periodic solutions on forced LED fireflies that constructed from an RC square wave generator with a periodic external force in order to simulate the synchronization of fireflies. On forced LED fireflies, characteristic periodic solutions called isolation periodic solution is observed at broad parameter regions. It can be considered these solutions causes synchronization phenomenon. Waveforms and periods of them are changed by border-collision bifurcations that are occurred by varying the frequency of an external force. Moreover, chaotic waveforms are observed at certain parameters. There can observe chaos waveform by a certain parameter.

### 1. Introduction

There is the autonomous oscillation is called rhythm phenomenon in creatures such as respiration and heart beat[1] [2] [3]. For example, there are the group singing of crickets, collective emission of fireflies and so on. In previous studies, in order to simulate the synchronization of fireflies, we proposed an electronic firefly circuit that constructed from an RC square wave generator and analyzed the synchronization in the mathematical model. We observe the bifurcation phenomena of periodic solutions in electronic firefly circuit with the periodic external force. Part of firefly is synchronized by light, is implemented by applying the phototransistor to square wave oscillator circuit, can be observed synchronization phenomena similarly the fireflies in the real world. On forced LED fireflies are six in total, rhythm of emission upon binding the circuit to each other depending on the type of circuit is synchro-

nized with same phase or reverse phase. Moreover, bifurcation phenomena on qualitative nature of the time waveform with a change of the parameters by using the Brute force method in Ito et al reported was also observed. However, the analysis of the electronic firefly in the prior studies have used mainly numerical analysis in mathematical models based on the ideal nature of the electronic circuit fireflies have been made. In this study, in the study the bifurcation phenomena of periodic solutions in electronic firefly under periodic external force, to perform numerical experiments and circuit experiments confirm the reasonableness of the phenomenon of a phenomenon and the actual circuit, which is observed in the ideal mathematical model to. In laboratory experiments, the light of any frequency is applied to the phototransistor of the electronic firefly circuits are compared with the results of simulation in a computer by using a function generator. In electronic circuits firefly plus a periodic external force is referred to as isolated periodic vibration, characteristic periodic solutions are obtained, they may be at different synchronization area occurs to cause a bifurcation. Therefore, the bifurcation of isolated periodic solution causes the confirmation of analysis of the phenomenon by using a computer experiment using the numerical methods, to observe the same phenomenon in the subsequent circuit experiment.

### 2. Electronic firefly circuit

We consider electronic firefly circuit. It is E with the maximum of the power supply voltage, circuit equation for the capacitor potential  $v$  is expressed by the following equation (1).

$$C_1 \frac{dv}{dt} = \begin{cases} -\frac{v}{R_2} & \text{if } v \geq \alpha E \\ \frac{v-E}{R_2} & \text{if } v \leq \beta E \end{cases} \quad (1)$$

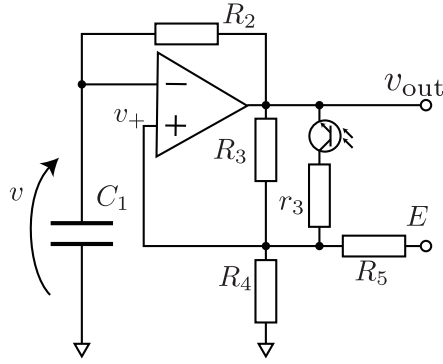

Figure 1: Electronic firefly circuit , Type A .

The following equation (1) is normalized circuit equation (2).

$$\frac{dx}{d\tau} = \begin{cases} -x & \text{if } x > \alpha \\ 1 - x & \text{if } x < \beta \end{cases} \quad (2)$$

$$(t = C_1 R_2 \tau, v = E x) \quad (3)$$

And since it is, the threshold  $\alpha, \beta$  is represented by the following equation (4).

$$\alpha_{\text{off/on}} = \frac{\frac{1}{R_3} + \frac{1}{R_5}}{\frac{1}{R_3} + \frac{1}{R_4} + \frac{1}{R_5}} \quad (4)$$

$$\beta_{\text{off/on}} = \frac{\frac{1}{R_5}}{\frac{1}{R_{\text{off/on}}} + \frac{1}{R_4} + \frac{1}{R_5}}$$

$$(R_{\text{off/on}} = R_3 \frac{R_3 r_3}{R_3 + r_3})$$

An example of the capacitor potential to change by the periodic external force in electronic firefly (Type A) it is shown in Fig.2. The trajectory of the capacitor potential  $x(t)$ . When electronic firefly detects the light input, the threshold change from  $\beta_{\text{off}}$  to  $\beta_{\text{on}}$ , according to the light it can be changed the threshold. Because, the photo-transistor is turned on, whereupon the combined resistance of the voltage divider circuit is reduced, as a result of the threshold  $\beta$  is lowered by Eq.(4).

### 2.1. Isolated periodic solution

On forced LED fireflies exist isolated periodic solutions that are periodic solutions occur in the synchronization phenomenon. The isolated periodic solution is periodic solution that asymptote a periodic solution in certain parameters, feature point exists single solution in solution orbit. The feature point, causing the synchronization phenomena becomes a phase lock. For example, we consider discharge capacitor, switch on optical input and  $\beta_{\text{on}} < x(t) < \beta_{\text{off}}$  in the threshold. Light input is on, so after a solution orbit

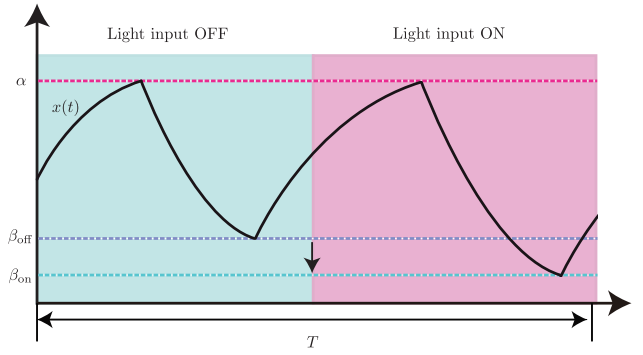

Figure 2: Capacitor potential to change by the periodic external force , Orbit of the capacitor potential  $x(t)$  , periodic  $T$  .

reached  $\beta_{\text{on}}$ , a solution orbit will be a turn charge mode, but when light input is switched over off, a minimum threshold value is switched over to  $\beta_{\text{off}}$ . However, because of the  $x(t) < \beta_{\text{off}}$ , so that the switch at the same time the circuit state is also match it to the charging state. As a result, the circuit state  $x(t)$  is a lower limit threshold  $\beta_{\text{off}}, \beta_{\text{on}}$  of neither, in the intermediate value ( $x_0$ ). When the Light input is switched so that the charging and discharging switch simultaneously.

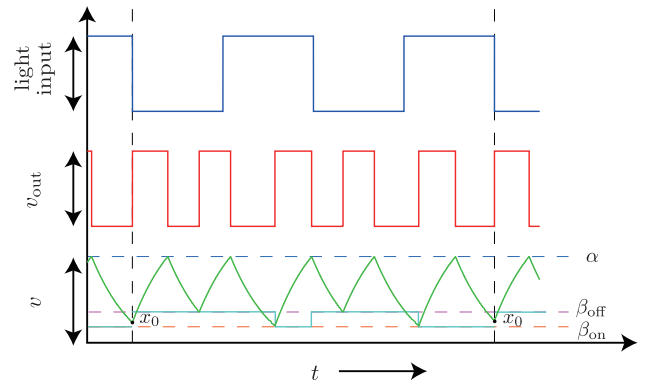

Figure 3: Isolated periodic waveform ,  $\alpha_{\text{off}} = \alpha_{\text{on}} = 0.7577$  ,  $\beta_{\text{off}} = 0.5155$  ,  $\beta_{\text{on}} = 0.0021$  ,  $T = 4.0$  .

### 2.2. Border-Collision bifurcation

$x_0$  is to move to the top and the bottom with the parameter change in the parameter I present with isolation periodic solution, and structural stability is maintained. However when movement of  $x_0$  with a parameter change finally reaches the threshold alpha and beta, the isolation periodic solution can't exist and become extinct. This phenomenon is called Border-Collision bifurcation. It is one of dynamic typical in the large bifurcation phenomena with the intermittent special quality. Two threshold values by which a threshold value is off, on exist by an electronic firefly circuit of this research,  $x_0$  saves and reaches those for a pos-

sibility that Border-Collision bifurcation happens. When doing, it occurs. In other words, it's clear that branch with two patterns can happen.

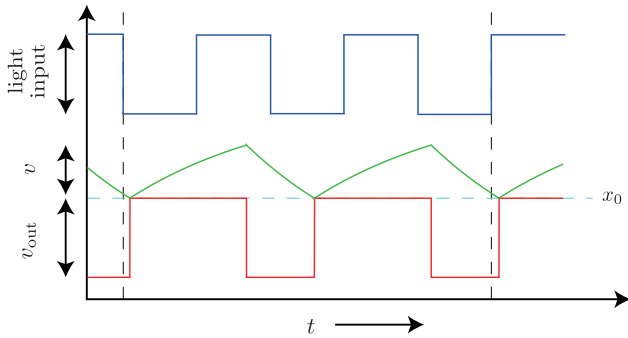

Figure 4: Border-Collision bifurcation ,  $\beta_{\text{off}} = x_0$  .

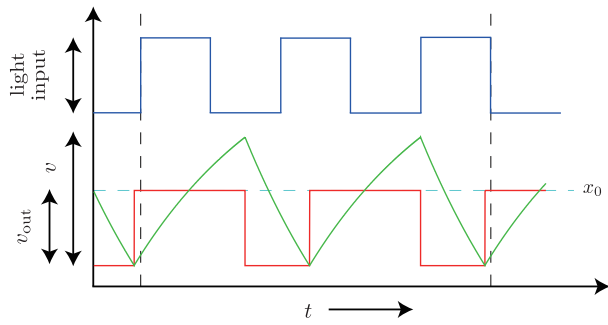

Figure 5: Border-Collision bifurcation ,  $\beta_{\text{on}} = x_0$  .

### 2.3. Special response of electronic firefly circuit

Figure 6 shows the steady-state response time waveform with parameter  $\alpha = 0.9$ ,  $\beta_{\text{off}} = 0.7$ ,  $\beta_{\text{on}} = 0.5$  and  $T = 0.8$ . From the figure, the turning point at the edge is seen multiple. However, they take all different positions, it is not observed periodicity in the time response waveform. Moreover, it was shown in the literature, unlike other non-periodic waveform, called a quasi-periodic waveform, it is considered to be chaotic phenomena. Compared to Fig.3, it can be seen that the threshold  $x_0$  is in irregular values.

### 3. Bifurcation analysis

We consider doing circuit implementation using a parameter in Fig.3 and observing isolation periodic waveform. In addition, changing the frequency of light, we observe occur Border-Collision bifurcation. The parameter is as follows.

$$\text{Comparator : LM741CM, } C_1 = 1\mu\text{F, } R_2 = 1\text{M}\Omega, \\ R_3 = R_4 = 100\text{k}\Omega, R_5 = 47\text{k}\Omega, r_3 = 100\Omega \quad (5)$$

$$\alpha_{\text{off}} = \alpha_{\text{on}} = 0.7577, \beta_{\text{off}} = 0.5155, \beta_{\text{on}} = 0.0021 \quad (6)$$

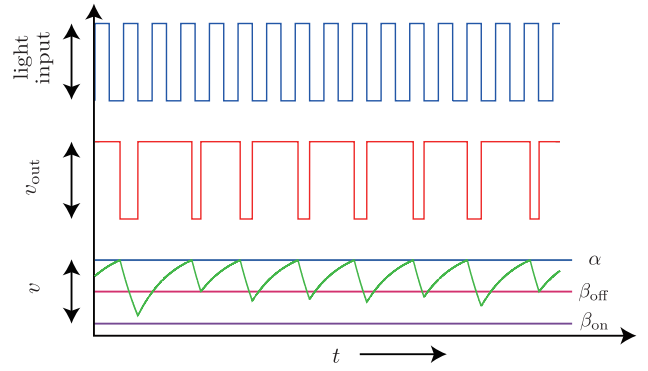

Figure 6: Chaos waveform ,  $\alpha_{\text{off}} = \alpha_{\text{on}} = 0.9$  ,  $\beta_{\text{off}} = 0.7$  ,  $\beta_{\text{on}} = 0.5$  ,  $T = 0.8$  .

Optical input waveforms from the top, the circuit of the output waveform, and has a capacitor voltage. Minus line, the threshold  $\beta_{\text{off}}$ ,  $\beta_{\text{on}}$ , and isolated periodic solution  $x_0$ . As the procedure of the experiment, the frequency of the circuit is fixed, the value of isolated periodic solutions by changing the frequency of the lighting a function generator. First, there are isolated periodic solutions under the conditions in Fig.3, therefore we could confirm the same waveform as the computer experiment. Fig.8 is increasing frequency of the light by Fig.7.  $x_0$  and  $\beta_{\text{off}}$  are the same value mostly. In other words, Fig.8 shows the Border-Collision bifurcation, it is changing the stationary property of the system. As a result, focusing the output waveform of the optical input and the circuit, it is not synchronized with an edge.

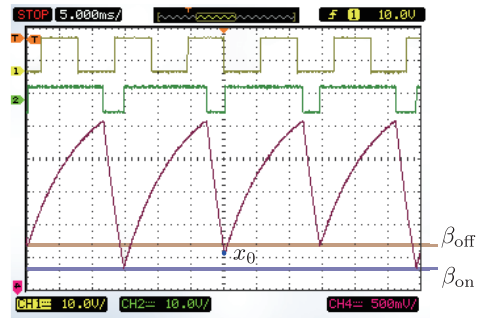

Figure 7: Isolated periodic waveform ,  $\beta_{\text{off}} = 0.5155$  ,  $\beta_{\text{on}} = 0.0021$  ,  $T = 0.111$  .

Next, when we set an appropriate parameter in a mathematics model by Fig6, we showed that a chaos phenomenon was observed in a real circuit. The parameter is as follows.

$$\text{Comparator : LMC6482, } C_1 = 1\mu\text{F, } R_2 = 100\text{k}\Omega, \\ R_3 = 62\text{k}\Omega, R_4 = 82\text{k}\Omega, R_5 = 11\text{k}\Omega, r_3 = 16\text{k}\Omega \quad (7)$$

$$\alpha_{\text{off}} = \alpha_{\text{on}} = 0.9073, \beta_{\text{off}} = 0.7583, \beta_{\text{on}} = 0.5627 \quad (8)$$

However, the parameter is a little different than computer experiment by error of element. Fig.9,10 can be analyzed

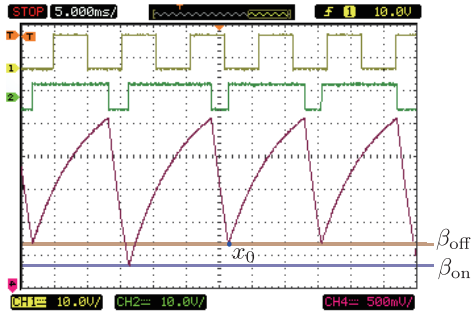

Figure 8: Border-Collision bifurcation ,  $\beta_{off} = 0.5155$  ,  $\beta_{on} = 0.0021$  ,  $T = 0.103$  .

irregular same as the computer experiment. Turning points are located between  $\beta_{off}$  and  $\beta_{on}$  while those points can't observe periodicity. In other words, the time waveform is chaotic waveforms, it agrees very well with the results of numerical experiments.

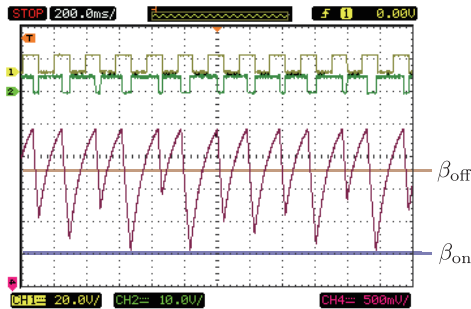

Figure 9: Chaos waveform ,  $\alpha_{off} = \alpha_{on} = 0.8977$  ,  $\beta_{off} = 0.7624$  ,  $\beta_{on} = 0.5002$  ,  $T = 1.8$  .

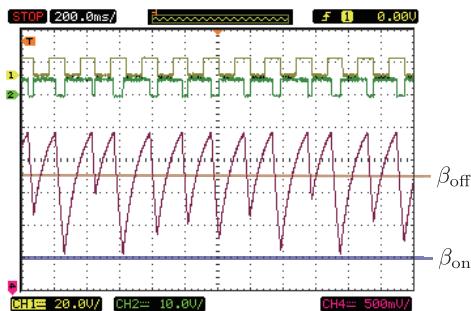

Figure 10: Chaos waveform ,  $\alpha_{off} = \alpha_{on} = 0.8977$  ,  $\beta_{off} = 0.7624$  ,  $\beta_{on} = 0.5002$  ,  $T = 1.8$  .

#### 4. Conclusion

In this paper, we conducted experiments on forced LED fireflies to simulate Synchronization phenomenon of the fireflies. There is called isolation periodic waveform observed in Synchronization phenomenon on forced LED

fireflies. Additionally, when it changes parameter of the threshold, there can ascertain border-collision bifurcations. There confirmed chaos waveform by a certain parameter.

In the future works, we try designing the new electronic firefly circuit and observing synchronization phenomenon with the new circuit and the current circuit.

#### References

- [1] J. Buck and E. Buck, "Synchronous Fireflies," Sci. Am., Vol.234 No.5, pp 74-85, 1976.
- [2] W. Garver and F. Moss, "Electronic Fireflies," Sci. Am., Vol.269, pp. 128-130, 1993.
- [3] S.H. Strongatz and I. Stewart, "Coupled Oscillators and Biological Synchronization," Sci. Am., Vol.269, pp.102-109, 1993.
- [4] M.Sekikawa et al., "Synchronization phenomena in square-wave oscillators with optical coupling," Technical report of IEICE, Vol.111, No.243, pp.73-78, Dec.2011.
- [5] T.Kosaka et al., "Synchronization of electric fireflies by using square wave generators," IECIE Trans.Fundamentals, Vol.E81-A, No.4, 1998.
- [6] D.Ito et al., "Waveforms observed in the forced LED firefly oscillator," Technical report of IEICE, Vol.NLP2014-132, pp113-116,2015.