

Border Collision Bifurcations in a Simple Switching Circuit

Danièle Fournier-Prunaret[†], Laura Gardini[‡] and Pascal Charge[†]

[†]LATTIS-INSA, LAAS-CNRS, Université de Toulouse
 Toulouse, France

[‡]Department of Economics, University Carlo Bo
 Urbino, Italy

Email: pascal.charge@insa-toulouse.fr, danièle.fournier@insa-toulouse.fr, gardini@econ.uniurb.it

Abstract—A two-dimensional piecewise smooth continuous model describing a circuit proposed as chaos generator is analyzed. The parameter space is investigated in order to classify regions of existence of stable cycles, and regions associated with chaotic behaviors. Border collision bifurcation curves and degenerate flip bifurcation curves are analytically detected. Moreover, the homoclinic bifurcations occurring in cyclical chaotic regions leading to chaos in one-piece are also detected.

Keywords : Two-dimensional chaos generator, switched dynamical systems, piecewise map.

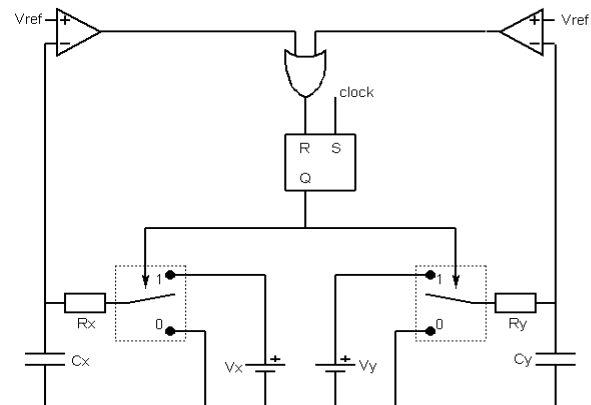

Figure 1: The circuit

1. Introduction

Chaotic signals appear to be interesting signals for many applications, particularly in telecommunications and transmissions. For some kind of applications, it is necessary to consider robust chaos [1], which can endure, even if parameters values are slightly changed. A way to obtain robust chaotic signals is to consider systems where border collision bifurcations appear [2][3][7][8]. We have previously proposed a chaos generator, which is a switching circuit where a latch is used to modify the behaviour of an analogical circuit, where such kind of bifurcations occur [4][5][6]. In this paper, we continue to analyze our circuit by considering border collision bifurcations and degenerate flip bifurcations and to put in evidence robust chaos. Our paper is organized as follows : in section 2, we recall the circuit and its modeling; in section 3, we analyze the bifurcations and the route to chaos in a peculiar case.

2. Description of the circuit

The circuit is shown in Figure 1 and its model has been introduced in a more detailed way in [4][5][6]. Just recall that the state variables of the system are the two voltage capacitor $v_x(t)$ and $v_y(t)$. At every clock period T , the flip-flop is set and then the switches position is '1'. When one of the capacitance voltages reaches the reference value V_{ref} , the two switches are turned toward their position '0'. So, according to the

switches position, the two capacitors are simultaneously charging or discharging. Thus, using classical models of circuits, we easily obtain the equations of the system. We consider the case when $V_x = V_y$. Let us recall the parameter normalization:

$$\alpha = \frac{V_x}{V_{ref}} > 1, \quad \mu = \frac{R_y C_y}{R_x C_x} > 0, \quad \delta = e^{-\frac{T}{R_x C_x}} < 1 \quad (1)$$

The normalized state variables are given by:

$$x_n = \frac{v_x(nT)}{V_{ref}} \in [0, 1], \quad y_n = \frac{v_y(nT)}{V_{ref}} \in [0, 1] \quad (2)$$

The following switching curves in $Q = [0, 1] \times [0, 1]$:

$$\begin{aligned} x &= x_b, & x_b &= \alpha - \frac{\alpha-1}{\delta} \\ y &= y_b, & y_b &= \alpha - \frac{\alpha-1}{\delta^{1/\mu}} \\ \Delta(x, y) &= 0, & \Delta(x, y) &= \left(\frac{\alpha-y}{\alpha-1}\right)^\mu - \frac{\alpha-x}{\alpha-1} \end{aligned} \quad (3)$$

assuming $x_b \geq 0$ and $y_b \geq 0$, which occurs for

$$\bar{\delta} < \delta < 1, \quad \bar{\delta} = \max \left\{ \frac{\alpha-1}{\alpha}, \left(\frac{\alpha-1}{\alpha}\right)^\mu \right\} \quad (4)$$

define three different domains in Q (see Figure 2):

$$\begin{aligned} D_1 &= \{(x, y) \mid 0 \leq x \leq x_b \text{ and } 0 \leq y \leq y_b\} \\ D_2 &= \{(x, y) \mid x_b \leq x \leq 1 \text{ and } \Delta(x, y) \geq 0\} \\ D_3 &= \{(x, y) \mid y_b \leq y \leq 1 \text{ and } \Delta(x, y) \leq 0\} \end{aligned} \quad (5)$$

in which the system is defined by different functions. In fact, the circuit is modelled by the map $(x_{n+1}, y_{n+1}) = T(x_n, y_n)$ as follows:

$$\begin{aligned}
 & \text{if } (x_n, y_n) \in D_1 : \\
 & T(x_n, y_n) = T_1(x_n, y_n) = \begin{cases} \alpha + (x_n - \alpha)\delta \\ \alpha + (y_n - \alpha)\delta^{1/\mu} \end{cases} \\
 & \text{if } (x_n, y_n) \in D_2 : \\
 & T(x_n, y_n) = T_2(x_n, y_n) = \begin{cases} \frac{\alpha - x_n}{\alpha - 1} \delta \\ (\alpha (\frac{\alpha - x_n}{\alpha - 1})^{1/\mu} - \alpha + y_n) \delta^{1/\mu} \end{cases} \\
 & \text{if } (x_n, y_n) \in D_3 : \\
 & T(x_n, y_n) = T_3(x_n, y_n) = \begin{cases} (\alpha (\frac{\alpha - y_n}{\alpha - 1})^\mu - \alpha + x_n) \delta \\ (\frac{\alpha - y_n}{\alpha - 1}) \delta^{1/\mu} \end{cases}
 \end{aligned} \tag{6}$$

It is easy to see that the map is well defined as T is continuous and maps the square Q (the phase space of interest) into itself.

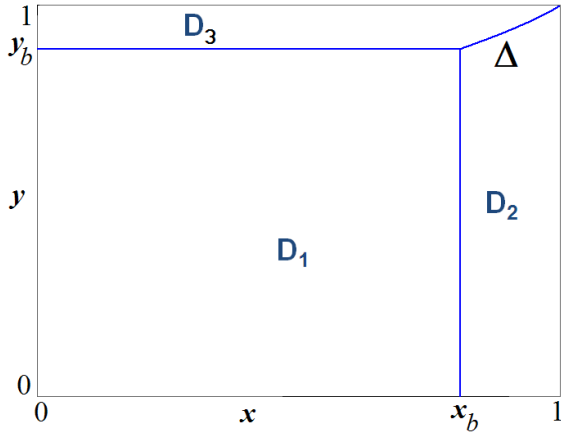

Figure 2: Phase space Q and three different regions D_i

3. Analysis of bifurcations and route to chaos

In this section we analyze the bifurcations occurring in the circuit modelled by T given in (6). The model is described by a continuous piecewise smooth map which depends on three parameters α , μ and δ , under the constraints given in (1) and (4). The function T_1 is affine and its fixed point, say $X_1^* = (x_1^*, y_1^*) = (\alpha, \alpha)$, is outside the square Q (as $\alpha > 1$) and thus it is a so-called virtual fixed point [2]. Moreover both eigenvalues of T_1 are positive and less than 1, so the virtual fixed point is a stable node. This implies that initial conditions inside the region D_1 are mapped towards the virtual attractor and are forced to enter in a different region, D_2 or D_3 , from which the iterated points are kept inside Q .

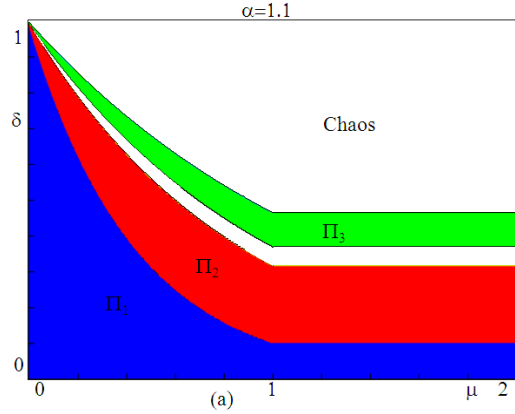

Figure 3: Bifurcation diagram in the parameter plane (μ, δ) at $\alpha = 1.1$. Colored regions denote the existence of stable k -cycles. The white region corresponds to the existence of robust chaos.

Figure 3 shows a two-dimensional bifurcation diagram in the parameter plane (μ, δ) obtained via numerical computations at $\alpha = 1.1$ fixed, in different colors are evidenced periodicity regions of attracting cycles. It is immediate to see a difference between the region in $\mu > 1$ and that in $\mu < 1$. The case $\mu = 1$ has been studied in [5]. It is enough to study one case only between $\mu > 1$ and $\mu < 1$, indeed, the following proposition holds:

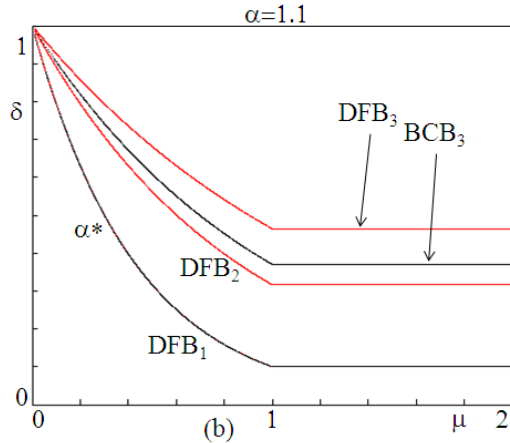

Figure 4: Some bifurcation curves obtained from Proposition 2 and corresponding to limit of periodicity regions in Figure 3.

Proposition 1. *The two cases $\mu > 1$ and $\mu < 1$ are topologically conjugated.*

The proof follows immediately due to the following

property:

$$\begin{aligned} T_1(x_n, y_n, \delta, \mu) &= T_1(y_n, x_n, \delta^{1/\mu}, 1/\mu) \\ T_2(x_n, y_n, \delta, \mu) &= T_3(y_n, x_n, \delta^{1/\mu}, 1/\mu) \end{aligned} \quad (7)$$

The case $\mu > 1$ has been extensively studied in [6]. In this paper, we present some results for the case $\mu < 1$. As it has been proved in [6] for $\mu > 1$, by using the following properties of T when $\mu < 1$:

- The dynamics of T are described by interactions between T_1 and T_3
- T_1 is an affine map,
- T_3 is a triangular map,
- we can do a change of variables in order to get a piecewise 2-dimensional smooth map, for which we know very well the dynamics and the bifurcations; it is then possible by reversing the variables to get the bifurcation curves for our system,

we obtain the following proposition :

Proposition 2.

1. Let $\mu < 1$ and $\alpha > \alpha^* = 1 + \delta^{1/\mu}$. Then the fixed point X_3^* of T_3 is globally attracting in the state space Q . At $\alpha = \alpha^*$ a degenerate flip bifurcation occurs and an arc of invariant curve in the region D_3 is filled with stable 2-cycles. (cf. Figure 5)

Let now $1 < \alpha < \alpha^* = 1 + \delta^{1/\mu}$. Then :

2. The stable 2-cycle of T undergoes a degenerate flip bifurcation, at the bifurcation curve given by:

$$DFB_2 : \quad \alpha = 1 + \delta^{2/\mu} \quad (8)$$

which may lead to m -cyclical chaotic sets of any even period m , which undergo bifurcations, merging in pair, up to a one-piece chaotic set.

3. For any $k \geq 3$ pairs of k -cycles, one of which may be locally stable and one unstable, appear via border collision bifurcation crossing the bifurcation curve BCB_k given by:

$$BCB_k : \quad \alpha = 1 + \frac{(1 - \delta)\delta^{(k-1)/\mu}}{1 - \delta^{(k-1)/\mu}} \quad (9)$$

which are maximal cycles, the stable one has one periodic point in D_3 and $(k-1)$ points in D_1 ; the unstable one has two periodic points in D_3 and $(k-2)$ points in D_1 .

4. For any $k \geq 3$ the stable k -cycle undergoes a degenerate flip bifurcation at the bifurcation curve given by:

$$DFB_k : \quad \alpha = 1 + \delta^{k/\mu} \quad (10)$$

so that the stability region of the k -cycle (colored regions in Figure 3) is given by $(\alpha, \delta) \in \Pi_k =$

$$\left\{ (\alpha, \delta) \mid 1 + \delta^{k/\mu} < \alpha < 1 + \frac{(1-\delta)\delta^{(k-1)/\mu}}{1-\delta^{(k-1)/\mu}}, \bar{\delta} < \delta < 1 \right\} \quad (11)$$

5. Crossing the degenerate flip bifurcation DFB_k there is the appearance of $2k$ -cyclical chaotic sets, which merge into k -cyclical chaotic sets at the homoclinic bifurcation occurring at the bifurcation curve H_k given by:

$$H_k : \quad \alpha - \frac{\delta^{2k/\mu}}{(\alpha - 1)^2} = 0 \quad (12)$$

which in turn merge into one piece chaotic set at the homoclinic bifurcation occurring at the bifurcation curve H'_k given by:

$$H'_k : \quad \alpha - \frac{\delta^{k/\mu}}{(\alpha - 1)} = 0. \quad (13)$$

In fact the dynamic behaviors of the 2-dimensional map obtained after the change of variables is related to the dynamics of a one-dimensional skew tent map ([10] and references therein) which are completely known. This is the reason why we can obtain all the bifurcation curves analytically.

Results of Proposition 2 are illustrated in Figure 6 and Figure 7 via bifurcation diagrams. We can see the degenerate flip bifurcations for fixed point X_3^* , 2 and 3-cycles, border collision bifurcations for 3-cycles and homoclinic bifurcations for 6-pieces and 3-pieces chaotic attractors. A robust chaotic attractor is shown on Figure 8.

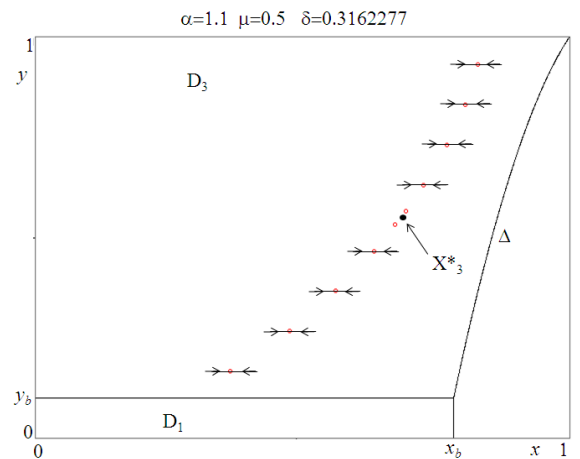

Figure 5: Degenerate flip bifurcation of fixed point X_3^* . Infinitely many 2-cycles exist on an invariant arc in D_3 , the stable set of which is the horizontal line through the cycles.

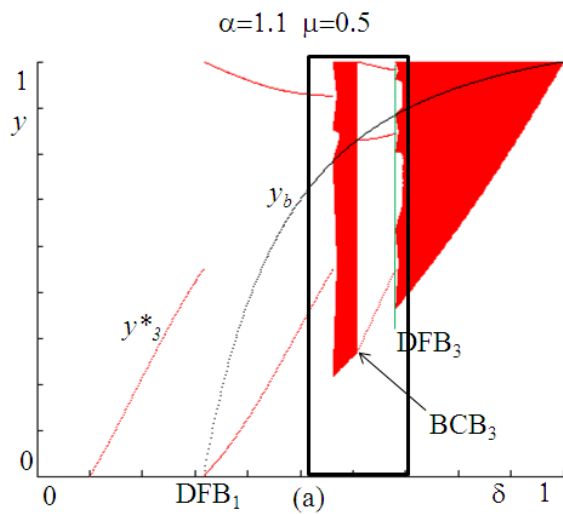

Figure 6: Bifurcation diagram in the plane (δ, y) .

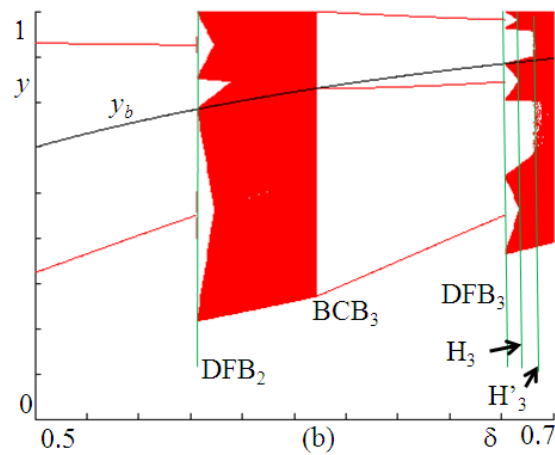

Figure 7: Bifurcation diagram, enlargement of Figure 6.

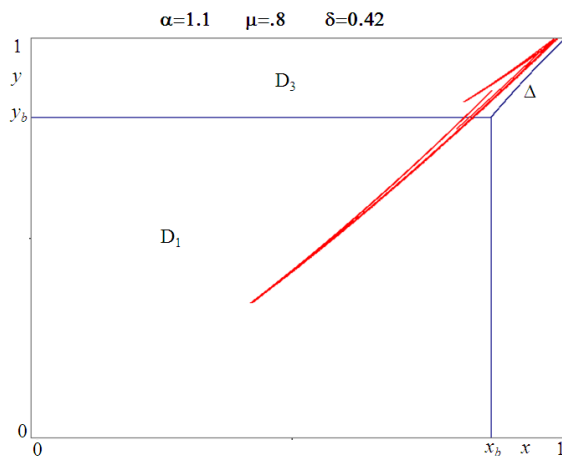

Figure 8: Robust chaotic attractor in the phase space (x, y) , located in D_1 and D_3 .

References

- [1] S. Banerjee, J.A. Yorke, C. Grebogi, "Robust chaos", *Physical Review Letters*, 80, 3049-3052, 1998.
- [2] S. Banerjee, P. Ranjan, C. Grebogi, "Bifurcations in 2D piecewise smooth maps - theory and applications in switching circuits", *IEEE Trans. Circuits Systems I*, 47, 633-643, 2000.
- [3] S. Mandal, S. Banerjee, "An Integrated CMOS Chaos Generator", *National Conference on Nonlinear and Dynamics*, Indian Institute of Technology, December 2003.
- [4] P. Chargé, D. Fournier-Prunaret, L. Gardini, "Two-dimensional Piecewise defined Maps realized with a Simple Switching Circuit", *International Conference on Nonlinear Theory and Applications (NOLTA'08)*, Budapest, Hungary, September 2008.
- [5] D. Fournier-Prunaret, P. Chargé, L. Gardini, "Border Collision Bifurcations and Chaotic Sets in a Two-dimensional Piecewise Linear Map", *Communications in Nonlinear Science and Numerical Simulations*, to appear, 2010.
- [6] L. Gardini, D. Fournier-Prunaret, P. Chargé, "Border Collision Bifurcations in a Two-Dimensional PWS Map from a Simple Circuit", submitted.
- [7] T. Kousaka, T. Kido, T. Ueta, H. Kawakami, M. Abe, "Analysis of Border-Collision Bifurcation in a Simple Circuit", *IEEE International Symposium on Circuits and Systems (ISCAS'00)*, Geneva, Switzerland, May 2000.
- [8] T. Kousaka, Y. Yasuhara, T. Ueta, H. Kawakami, "Experimental Realization of Controlling Chaos in the Periodically Switched Nonlinear Circuit", *Int. J. Bifurcation and Chaos*, Vol. 14, No. 10, pp. 3655-3660, 2004.
- [9] I. Sushko, L. Gardini, "Center bifurcation for two-dimensional border-collision normal form", *Int. J. Bifurcation and Chaos*, Vol. 18, No. 4, pp. 1029-1050, 2008.
- [10] I. Sushko, L. Gardini, "Degenerate Bifurcations and Border Collisions in Piecewise Smooth 1D and 2D Maps", *Int. J. Bifurcation and Chaos*, to appear, 2010.