

Frustrations in Strongly Coupled Polygonal Oscillatory Networks

Yoko Uwate[†], Yoshifumi Nishio[†] and Ruedi Stoop[‡]

[†]Dept. of Electrical and Electronic Engineering, Tokushima University
 2-1 Minami-Josanjima, Tokushima, Japan
 Email: {uwate, nishio}@ee.tokushima-u.ac.jp

[‡]Institute of Neuroinformatics, University / ETH Zurich,
 Winterthurerstrasse 190, CH-8057 Zurich, Switzerland,
 Email: ruedi@ini.phys.ethz.ch

Abstract—In this study, we investigate synchronization phenomena in two coupled polygonal oscillatory networks with strong frustrations. We focus on the amplitude of each oscillator when the coupling strength is increased. By using the computer simulations, we confirm that the amplitude of the oscillators decreases by increasing the coupling strength and oscillation death is occurred at un-frustrated oscillators.

1. Introduction

The synchronization phenomena observed from coupled oscillators are suitable model to analyze the natural phenomena. Therefore, many researchers have proposed different coupled oscillatory networks and have discovered many interesting synchronization phenomena [1]-[4].

In our research group, we have focused on synchronization phenomena of coupled oscillators under a difficult situation for the circuit. Setou et al. have reported the synchronization phenomena in N oscillators coupled by resistors as a ring. The oscillation stop in some range of the coupling resistors was confirmed [5].

We have investigated the synchronization phenomena in the coupled polygonal oscillatory networks sharing branches [6]. In this system, van der Pol oscillators are connected to every corner of polygonal network. By using computer simulations and theoretical analysis, we confirm that the coupled oscillators tend to synchronize to minimize the power consumption of the whole system. The phase difference of the shared oscillators is solved by finding the minimum value of the power consumption function. Furthermore, we have discussed synchronization state of the proposed oscillatory networks by changing the coupling parameter [7]. In this circuit system, we confirm that the amplitude of the shared and the other oscillators obtains different value. The torus attractors can be also observed in the certain parameter region. However, we could not observe oscillation death even if the coupling strength is set to very large value. In the circuit model of Ref. [7], the earth resistances are missing in the 3rd and the 4th oscillators. Namely, the network topology changes to just ring oscillators coupled by the inductors if the coupling strength

becomes large.

In this study, we consider new circuit model which is including the earth resistance in all ground parts. The synchronization phenomena in coupled polygonal oscillatory networks with strong frustration are investigated. We confirm that the amplitude of the oscillators decreases by increasing the value of the coupling strength and oscillation death is occurred at un-frustrated oscillators. We expect that the results of this study contribute to understanding of synchronization phenomena observed in general complex networks.

2. Two Coupled Oscillatory Networks

2.1. Symmetric Model

Two identical polygonal oscillatory networks are coupled by sharing a branch as shown in Fig. 1. In this circuit model, we consider the coupling method which two adjacent oscillators are tend to synchronize at anti-phase state. We call the first and the second oscillators which are connected to both side of polygonal network “shared oscillators.”

Figure 2 shows the circuit model of the 3 – 3 coupling networks. The novel part of this study is that the earth resistances are inserted to the 3rd and the 4th oscillators.

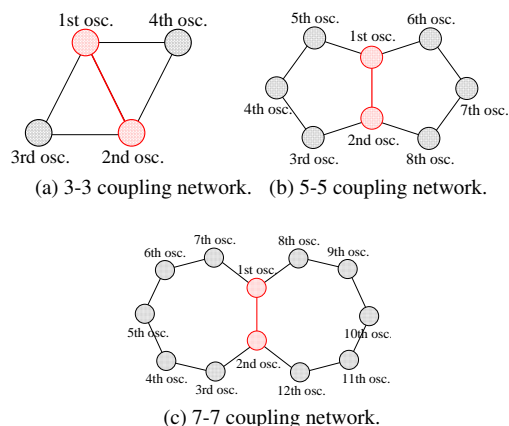

Figure 1: Two Coupled Oscillatory Networks (Symmetric Model).

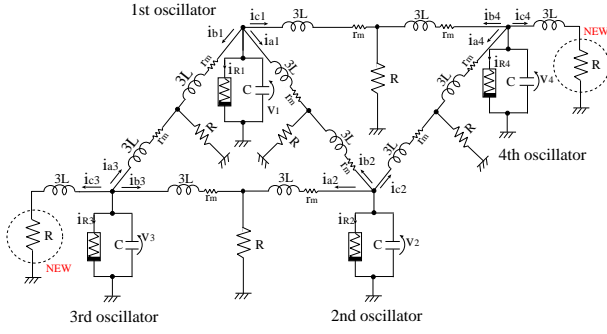

Figure 2: Coupling Model (3 – 3 coupling networks).

Next, we develop the expression for the circuit equations of 3 – 3 coupling oscillatory networks as shown in Fig. 2. The $v_k - i_{Rk}$ characteristics of the nonlinear resistor are approximated by the following third order polynomial equation,

$$i_{Rk} = -g_1 v_k + g_3 v_k^3 \quad (g_1, g_3 > 0), (k = 1, 2, 3, 4). \quad (1)$$

The normalized circuit equations governing the circuit are expressed as
[kth oscillator]

$$\begin{cases} \frac{dx_k}{d\tau} = \varepsilon \left(1 - \frac{1}{3} x_k^2 \right) x_k - (y_{ak} + y_{bk} + y_{ck}) \\ \frac{dy_{ak}}{d\tau} = \frac{1}{3} \left\{ x_k - \eta y_{ak} - \gamma (y_{ak} + y_n) \right\} \\ \frac{dy_{bk}}{d\tau} = \frac{1}{3} \left\{ x_k - \eta y_{bk} - \gamma (y_{bk} + y_n) \right\} \\ \frac{dy_{ck}}{d\tau} = \frac{1}{3} \left\{ x_k - \eta y_{ck} - \gamma (y_{ck} + y_n) \right\} \end{cases} \quad (k = 1, 2, 3, 4). \quad (2)$$

where

$$t = \sqrt{LC} \tau, \quad v_k = \sqrt{\frac{g_1}{3g_3}} x_k, \quad i_{ak} = \sqrt{\frac{g_1}{3g_3}} \sqrt{\frac{C}{L}} y_{ak},$$

$$i_{bk} = \sqrt{\frac{g_1}{3g_3}} \sqrt{\frac{C}{L}} y_{bk}, \quad \varepsilon = g_1 \sqrt{\frac{L}{C}},$$

$$\gamma = R \sqrt{\frac{C}{L}}, \quad \eta = r_m \sqrt{\frac{C}{L}},$$

$$(k = 1, 2, 3, 4).$$

In this equations, γ is the coupling strength, ε denotes the nonlinearity of the oscillators and y_n denotes the current of neighbor oscillator on coupling resistor.

Figure 3 shows the observed attractors of 3 – 3 coupling network by changing the coupling strength. When the coupling strength is weak, the amplitude of all oscillators are almost same as shown in Fig. 3(A). By increasing the value of the coupling strength, the amplitude of the shared oscillators becomes smaller than the others (Fig. 3(B), (C)). When the coupling strength is larger than $\gamma=0.8$, oscillation death of all oscillators is observed as shown in Fig. 3(D).

Next, Fig. 4 shows the observed attractors of 5 – 5 coupling network by changing the coupling strength. In this circuit model, the amplitude of fourth oscillator (which is located farthest place from the shared oscillators) decreases with the coupling strength. We observe the oscillation death of the fourth oscillator when the coupling strength is set to $\gamma = 1.0$. In the case of 7 – 7 coupling network, we observe similar results with 5 – 5 coupling network as shown in Fig. 5.

Figure 6 shows the change of the amplitude observed from each network. In the case of 3 – 3 coupling network, oscillation death of all oscillators is occurred at same time. While, in the cases of 5 – 5 and 7 – 7 coupling networks, first, the oscillation death of the oscillators located farthest place from the shared oscillators is occurred. After that, the other oscillators stop to oscillate at same time.

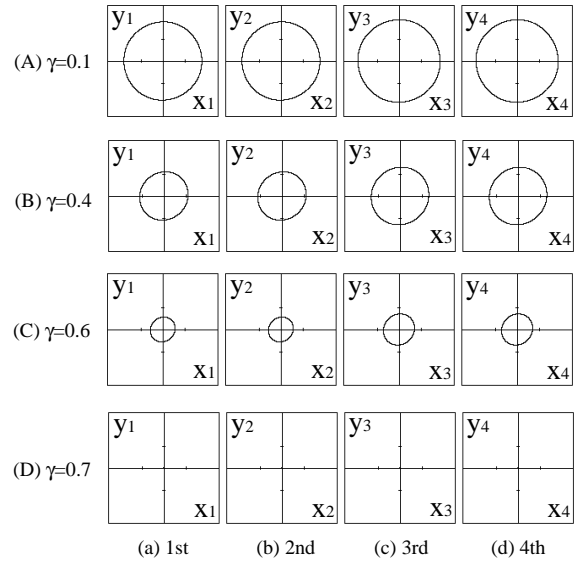

Figure 3: Attractor (3-3 coupling network).

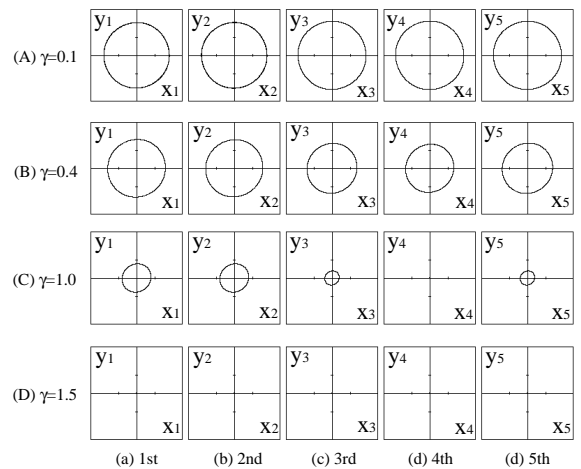

Figure 4: Attractor (5-5 coupling network).

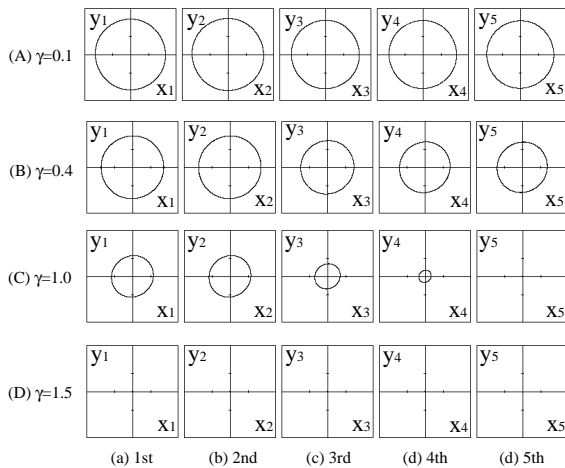
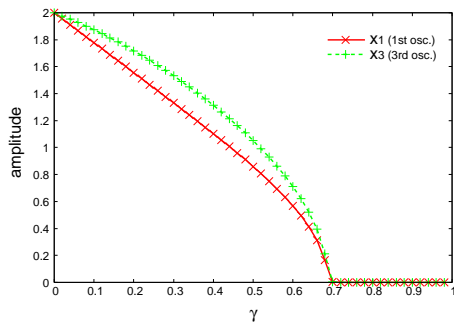
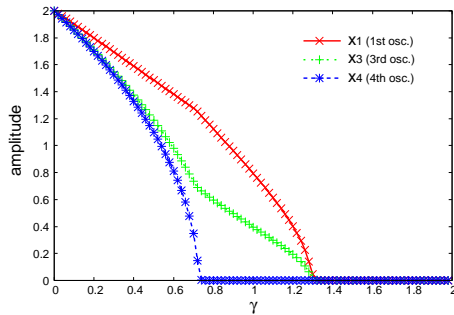

Figure 5: Attractor (7-7 coupling network).



(a) 3-3 coupling network.



(b) 5-5 coupling network.

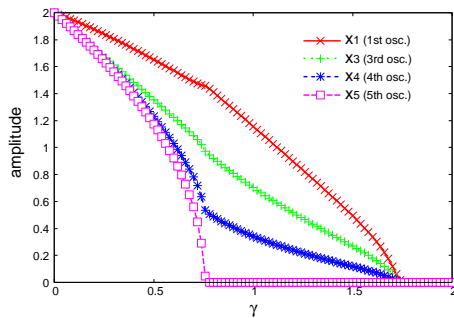

(c) 7-7 coupling network.

Figure 6: Amplitude (Symmetric Model).

2.2. Asymmetric Model

Next, we consider the asymmetric models such as 3 – 5 coupling network, 3–7 coupling network and 5–7 coupling network. The asymmetric models are shown in Fig. 7.

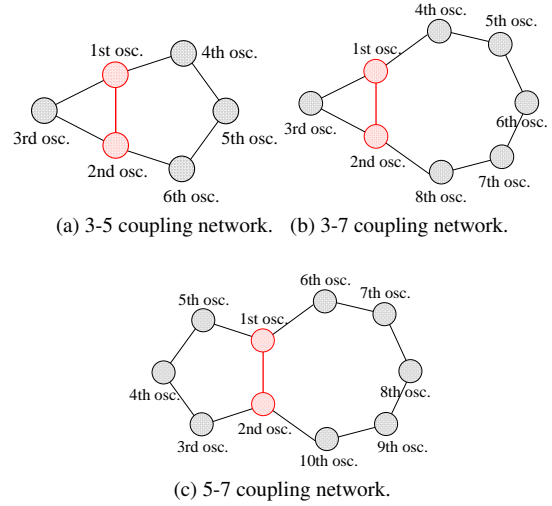

Figure 7: Two Coupled Oscillatory Networks (Asymmetric Model).

Figure 8 shows the change of the amplitude observed from the asymmetric networks. In the case of 3–5 coupling network, oscillation death of all oscillators is occurred at same time. While, in the cases of 3 – 7 and 5 – 7 coupling networks, first the oscillation death of the oscillators located farthest place from the shared oscillators is occurred. After that, the other all oscillators stop to oscillate at same time. These results are similar with the results with the symmetric network models. However, we observe the oscillation of the amplitude in 3 – 7 coupling network when the coupling strength is set to around $\gamma = 0.75$.

Figure 9 shows one example or the change of the amplitude when the coupling strength is set to $\gamma = 0.75$. In this case, we confirm that the amplitude change can be observed constantly as shown in Fig. 10(a). There are two pairs (1st-4th-5th and 2nd-7th-8th) of oscillation types of the amplitude and these two pairs oscillate with anti-phase state. While the other two amplitudes (3rd and 6th) oscillate with in-phase state. By increasing the coupling strength, the oscillation death of the 3rd and 6th oscillators is occurred. Finally, we summarize the network types depending on the amplitude change as shown in Fig. 10(b).

3. Conclusions

In this study, we have investigated synchronization phenomena in coupled polygonal oscillatory networks with strong frustrations. We focused on the amplitude of each oscillator when the coupling strength is increased. By using the computer simulations, we confirmed that the amplitude of the oscillators decreases by increasing the

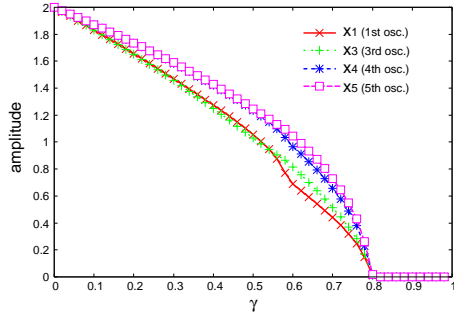

(a) 3-5 coupling network.

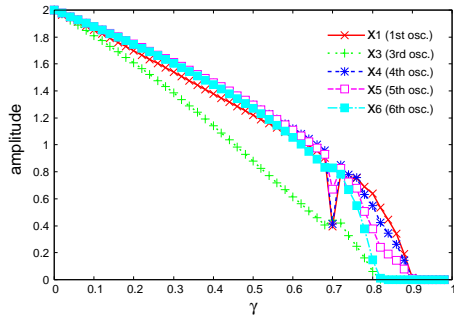

(b) 3-7 coupling network.

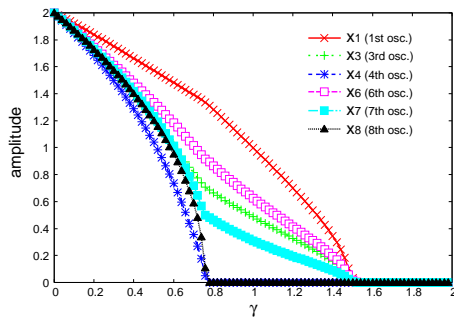

(c) 5-7 coupling network.

Figure 8: Amplitude (Asymmetric Model).

coupling strength and oscillation death is occurred at unfrustrated oscillators. Furthermore, we observed the amplitude change in the asymmetric network model.

Acknowledgment

This work was partly supported by JSPS Grant-in-Aid for Challenging Exploratory Research 26540127.

References

[1] M.G. Rosenblum, A.S. Pikovsky, and J. Kurths, "Phase Synchronization of Chaotic Oscillators" *Physical Review Letters*, vol.76, no.11, pp.1804-1807, Mar. 1996.

[2] W. Wang, I.Z. Kiss, and J.L. Hudson, "Experiments on Arrays of Globally Coupled Chaotic Electrochemical Oscilla-

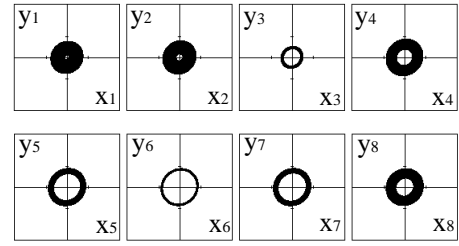
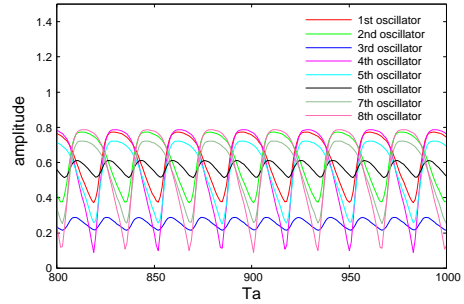
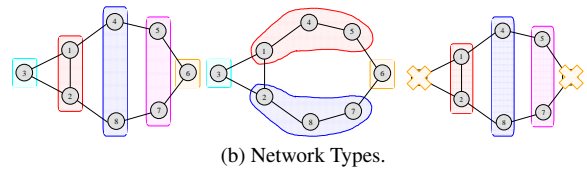

Figure 9: Attractors (3-7 coupling network, $\gamma=0.75$).



(a) Amplitude



(b) Network Types.

Figure 10: Amplitude Change (3 – 7 coupling network, $\gamma=0.75$).

tors: Synchronization and Clustering" *Chaos*, vol.10, no.1, pp.248-256, Mar. 2000.

[3] M. Yamauchi, Y. Nishio and A. Ushida, "Phase-waves in a ladder of oscillators" *IEICE Trans. Fundamentals*, vol.E86-A, no.4, pp.891-899, Apr. 2003.

[4] H.B. Fotsina and J. Daafouza, "Adaptive synchronization of Uncertain Chaotic Colpitts Oscillators based on Parameter Identification" *Physics Letters A*, vol.339, pp.304-315, May 2005.

[5] Y. Setou, Y. Nishio and A. Ushida, "Synchronization Phenomena in Many Oscillators Coupled by Resistors as a Ring," *Proc. of APCCAS'94*, pp. 570-575, Dec. 1994.

[6] Y. Uwate and Y. Nishio, "Synchronization in Several Types of Coupled Polygonal Oscillatory Networks," *IEEE Trans. Circuits Syst. I*, vol. 59, no. 5, pp. 1042-1050, May 2012.

[7] Y. Uwate and Y. Nishio, "Frustrated Synchronization in Two Coupled Polygonal Oscillatory Networks," *Proc. of IS-CAS'13*, pp. 1781-1784, May 2013.