

Synchronization Phenomena in Different Sizes of Rings of Coupled Oscillators

Honami KUME, Yoko UWATE and Yoshifumi NISHIO

Department of Electrical and Electronic Engineering, Tokushima University
 2-1 Minami-Josanjima, Tokushima 770-8506, Japan

Email: honami@ee.tokushima-u.ac.jp, uwate@ee.tokushima-u.ac.jp, nishio@ee.tokushima-u.ac.jp

Abstract—In this study, two rings of 5 and 7 van der Pol oscillators coupled by resistors are researched. These rings show 5-phase and 7-phase synchronizations when they are not coupled. Hence, the whole system becomes a frustrated network after coupling. We investigate synchronization phenomena by computer simulations.

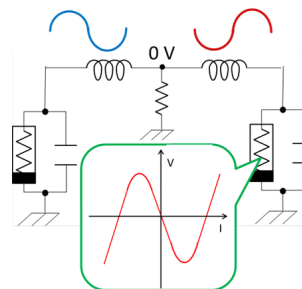

Figure 2: Anti-phase of two oscillators.

1. Introduction

System of coupling oscillators is useful as a simple model that represents the natural phenomena, because it has a variety of phenomena depending on coupling method[1][2]. We focus on the “Frustration Phenomena” occurred by coupling two different characteristics.

In this study we prepare two different sizes of rings of coupled van der Pol oscillators, and we joined two rings like n_1 and n_2 in Fig. 1. In our past study, coupling van der Pol oscillators as a ring show unique phenomenon [3]. Neighboring two oscillators have anti-phase as Fig. 2. The phase state depends on the number of oscillators in a ring. Even number of oscillators reach only anti-phase, but odd number of oscillators reach some states with phase differences. For example, 5 oscillators coupled as a ring show 5-phase synchronization, and 7 oscillators case reach 7-phase synchronization. If we couple two different sizes of rings, 5 oscillators and 7 oscillators, they may affect each other and frustration occurs. We research synchronization phenomena in the 5-7 rings shown in Fig. 3.

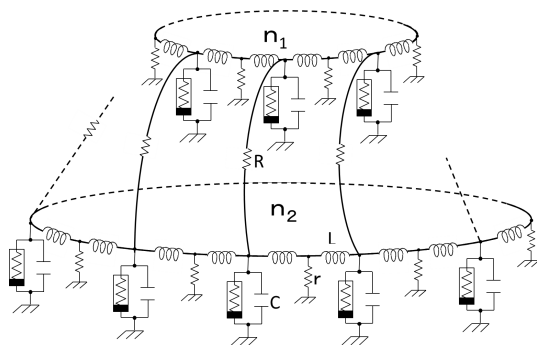

Figure 1: Two rings of coupled oscillators.

2. Circuit Model

The 5-7 rings have three kinds of coupling types as shown in Fig. 4. We name Type A, B and C. The two oscillators in the lower ring (among oscillators) with no direct connections to the upper ring are called “Free Oscillator” in this article. In Type A, Free Oscillators are neighboring. In Type B, there is an oscillator connected to the upper ring between two Free Oscillators. In Type C, there are two oscillators connected to the upper ring between two Free Oscillators.

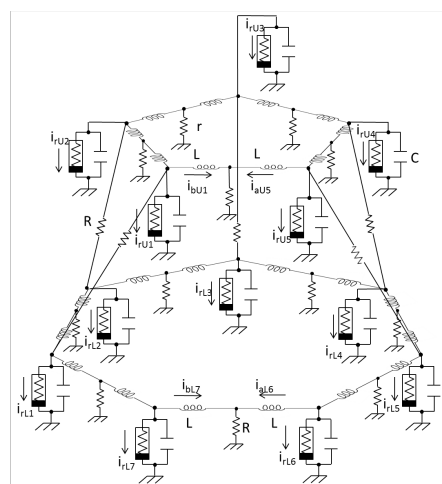

Figure 3: Circuit model of 5-7 rings.

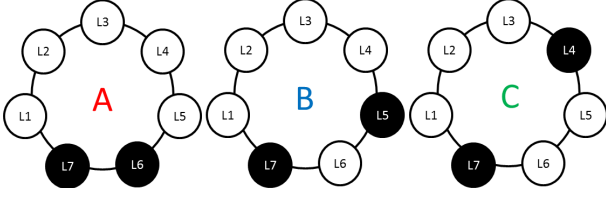

Figure 4: Three types of coupling methods. Black oscillators are Free Oscillators.

3. Circuit Equations

We show the circuit equations of Type A. Type B and Type C have similar equations to Type A. The circuit equations for Type A are shown below.

$$C \frac{dv_k}{dt} = \begin{cases} -i_{rk} - (i_{ak} + i_{bk}) - \frac{1}{R}(v_k - v_j) \\ \quad : (k = U1 \sim U5) \\ \quad \quad : (j = L1 \sim L5) \\ -i_{rk} - (i_{ak} + i_{bk}) + \frac{1}{R}(v_j - v_k) \\ \quad : (k = L1 \sim L5) \\ \quad \quad : (j = U1 \sim U5) \\ -i_{rk} - (i_{ak} + i_{bk}) \\ \quad : (k = L6, L7) \end{cases} \quad (1)$$

$$L \frac{di_{ak}}{dt} = v_k - r(i_{ak} + i_{b(k+1)})$$

$$L \frac{di_{bk}}{dt} = v_k - r(i_{a(k-1)} + i_{bk})$$

$$: (k = U1 \sim U5, L1 \sim L5)$$

We assume that the characteristics of the nonlinear resistors are described by the following equation.

$$i_{rk} = -g_1 v_k + g_3 v_k^3 \quad (2)$$

We normalize the above equations and they are shown below.

$$\frac{dx_k}{d\tau} = \begin{cases} \varepsilon(x_k - \frac{1}{3}x_k^3) - (y_{ak} + y_{bk}) - \gamma(x_k - x_j) \\ \quad : (k = U1 \sim U5) \\ \quad \quad : (j = L1 \sim L5) \\ \varepsilon(x_k - \frac{1}{3}x_k^3) - (y_{ak} + y_{bk}) + \gamma(x_j - x_k) \\ \quad : (k = L1 \sim L5) \\ \quad \quad : (j = U1 \sim U5) \\ \varepsilon(x_k - \frac{1}{3}x_k^3) - (y_{ak} + y_{bk}) \\ \quad : (k = L6, L7) \end{cases} \quad (3)$$

$$\frac{dy_{ak}}{d\tau} = x_k - \eta(y_{ak} + y_{b(k+1)})$$

$$\frac{dy_{bk}}{d\tau} = x_k - \eta(y_{a(k-1)} + y_{bk})$$

$$: (k = U1 \sim U5, L1 \sim L5)$$

where

$$v_k = \sqrt{\frac{g_1}{3g_3}} x_k,$$

$$i_{ak} = \sqrt{\frac{g_1}{3g_3}} \sqrt{\frac{C}{L}} y_{ak}, \quad i_{bk} = \sqrt{\frac{g_1}{3g_3}} \sqrt{\frac{C}{L}} y_{bk}, \quad (4)$$

$$t = \sqrt{LC}\tau, \quad \varepsilon = g_1 \sqrt{\frac{L}{C}},$$

$$\eta = r \sqrt{\frac{C}{L}}, \quad \gamma = \frac{1}{R} \sqrt{\frac{L}{C}}$$

The parameter γ is a coupling strength between the two rings. We research synchronization phenomena when we change γ from 0.001 to 1.0. The parameter η shows coupling strength between oscillators in the same ring. The strength of the nonlinearity is ε . We fix $\eta = 0.1$ and $\varepsilon = 1.0$.

4. Simulation Results

Figures 5, 6 and 7 show attractors of Type A, B and C, respectively, and the horizontal axis is x that means voltage and the vertical axis is y that means current. In all the figures, the coupling strength between the rings γ are changed as 0.001, 0.01, 0.1, and 1.0 from the top. For each case, the horizontally-aligned 5 attractors in the figure correspond to the oscillators in the upper ring, while the horizontally-aligned 7 attractors correspond to the oscillators in the lower ring. The position of the 5 attractors

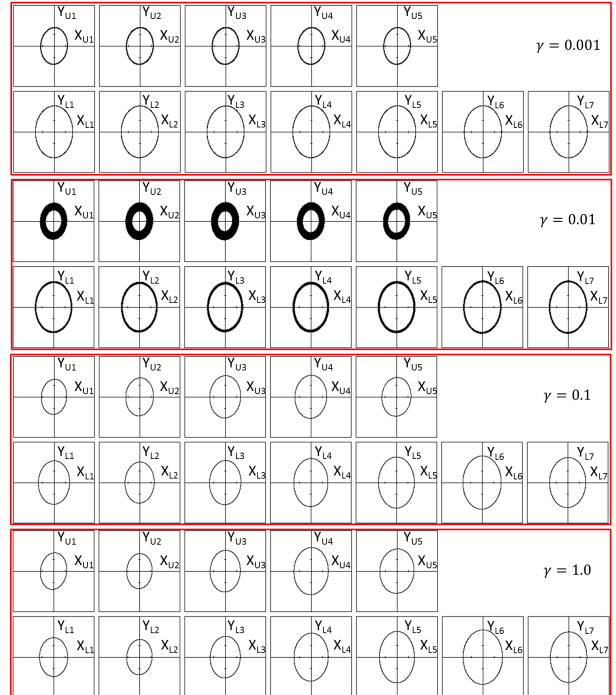

Figure 5: Attractors of Type A.

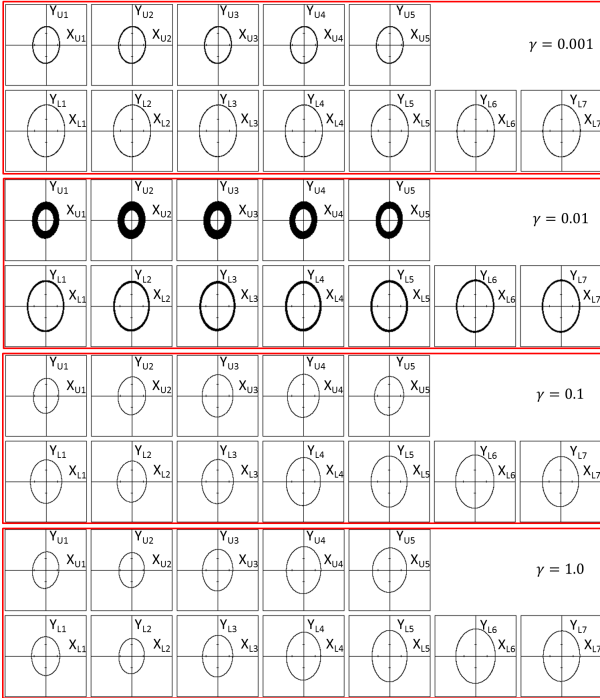

Figure 6: Attractors of Type A.

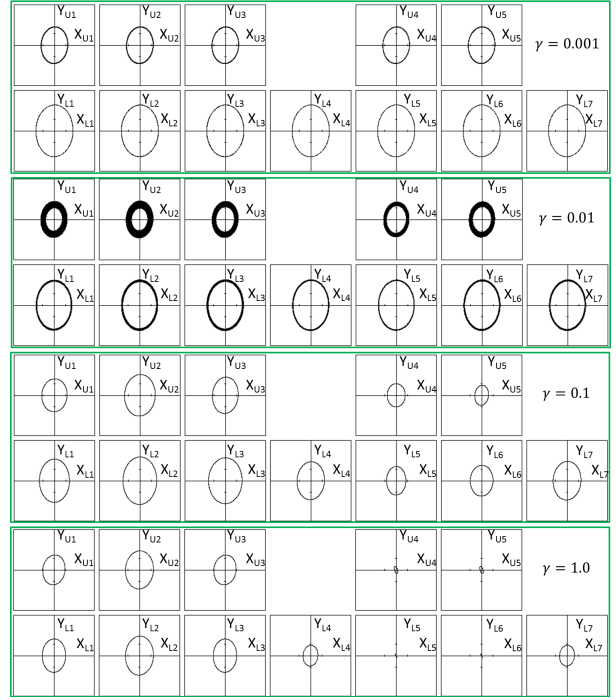

Figure 7: Attractors of Type C.

corresponds to the connections between the rings.

For $\gamma = 0.001$, the 5 attractors are the same size for the all types of the connections as shown in Figs. 5, 6 and 7. This is because the upper 5 oscillators are not concerned from lower 7 oscillators.

For $\gamma = 0.01$, the amplitudes of attractors keep changing. Because one ring is concerned by the other ring, and frustration between 5-phase and 7-phase occurs.

For $\gamma = 0.1$, all oscillators synchronize except the oscillator between the Free Oscillators in Type B. Note that the amplitudes of the two oscillators between the Free Oscillators in Type C become small. These are the effect of the frustration.

For $\gamma = 1.0$, the amplitudes of the oscillators become smaller by the frustrations and we can see that the effect depends on the position of the oscillators.

Figure 8 shows the synchronization between the two rings. From Fig. 8(a), we can understand that x_{U1} and x_{L1} become to synchronize as γ increases. From Fig. 8(b), we can see that the oscillators with strong frustrations become to stop oscillating.

Figure 9 shows characteristics of average phase differences from x_{U1} . Upper 5 oscillators of all types exhibit 5-phase synchronization for $\gamma = 0.001$. In Type A, the phase become a change from 5-phase but not reach anti-phase. As γ increases, Type B and Type C becomes anti-phase synchronization, although Type A does not show any synchronization.

5. Conclusions

In this study, we have researched synchronization phenomena observed from two rings with different sizes of coupled van der Pol oscillators. We observed attractors and phase relationship by computer simulations. We could observe frustration phenomena between the rings and obtained different results from three coupling method. In future research, we carry out circuit experiments and collect data of many cases from computer simulations.

References

- [1] S. Yamane, T. Imoto and M. Yamauchi, "Investigation and Application of the Phenomena in Coupled Oscillators as a Lattice", Technical Report of IEICE, NLP107(400), pp.51-56, Jan. 2008.
- [2] K. Ochiai and K. Shimizu, "Experimental Study of a Switching Phenomenon in Two Coupled Hard-Type Oscillators", Technical Report of IEICE, NLP113(69), pp.7-11, May. 2013.
- [3] Y. Setou, Y. Nishio and A. Ushida, "Synchronization Phenomena in Oscillators Coupled by Resistors as a Ring", Technical Report of IEICE, NLP93-89, pp.31-37, Mar. 1994.

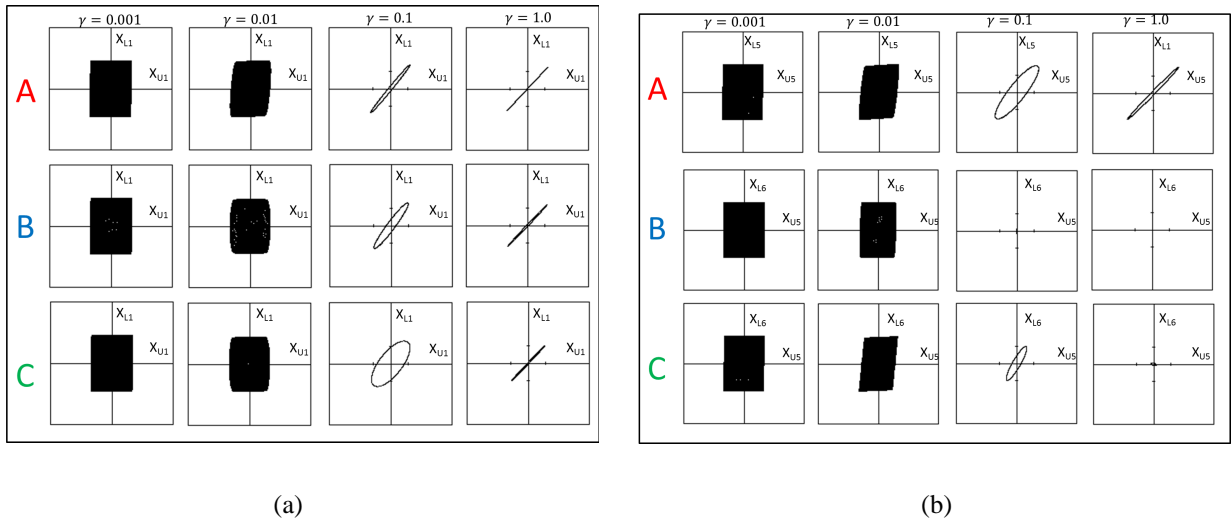

Figure 8: Synchronization between the two rings for different γ . (a) $x_{U1} - x_{L1}$. (b) $x_{U5} - x_{L5}$ for Type A and $x_{U5} - x_{L6}$ for Types B and C.

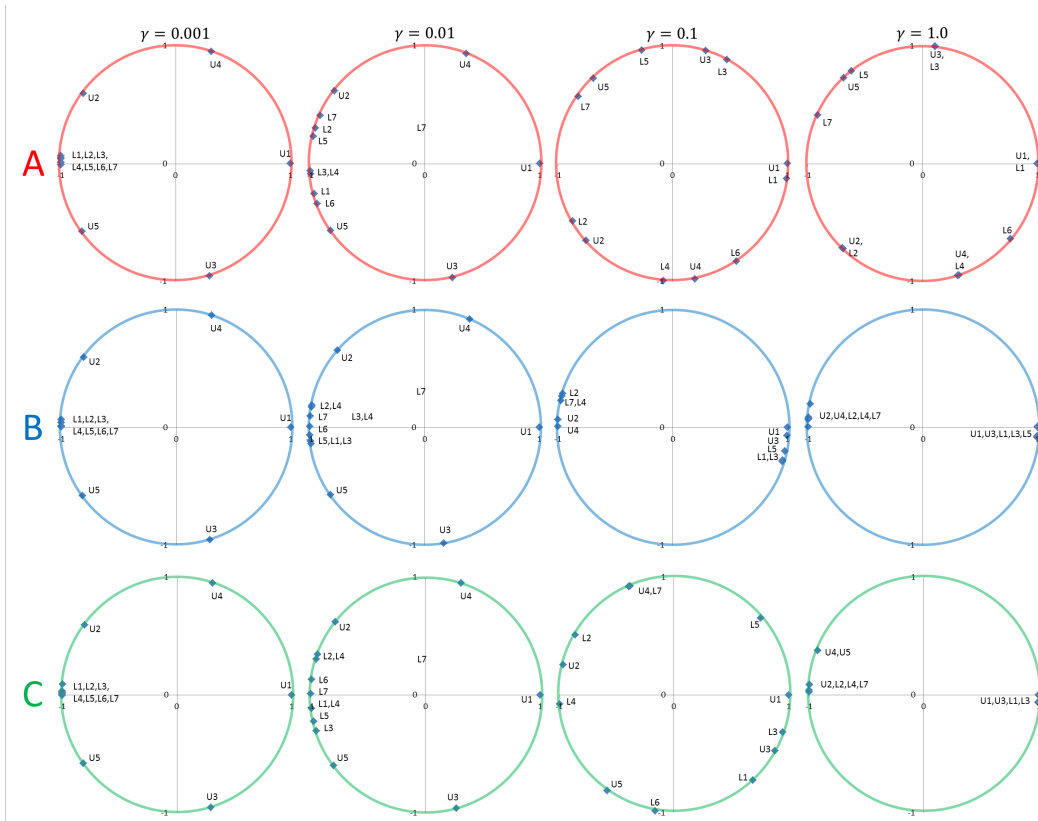

Figure 9: Average phase for different γ .