

FCC-Compliant Operation of Low-Rate UWB Impulse Radio Applying Multiple Pulses per Bit

Tamás Krébesz[†], Géza Kolumbán[†], Chi K. Tse[‡] and Francis C. M. Lau[‡]

[†]Faculty of Information Technology, Pázmány Péter Catholic University
 Budapest, Hungary

Email: {krebesz,kolumban}@itk.ppke.hu

[‡]Dept. of Electronic and Information Engineering, The Hong Kong Polytechnic University
 Hung Hom, Hong Kong SAR, China

Email: {encktse,encmlau}@polyu.edu.hk

Abstract— Starting from the FCC Regulations and the IEEE UWB standard this contribution derives the required specifications for the blocks of UWB transceivers. It shows that if CMOS technology is used then the coverage of UWB impulse radio is limited by the low supply voltage. To overcome this limit more than one UWB carrier pulse is used to keep transmitted energy per bit high enough but to reduce the required voltage swing below the supply voltage. The optimum value of delay to be set between two successive UWB pulses is determined and the effect of frequency detuning is studied.

1. Introduction

Based on the already approved FCC Regulations and the IEEE Standard, the paper derives the system parameters for the Low-Rate (LR) Ultra-WideBand (UWB) Impulse Radio (IR) transceivers and their circuits. The key parameter is the peak pulse amplitude that determines the voltage swing in the UWB transceiver circuits. It is shown that the peak pulse amplitude allowed by the FCC Regulations cannot be exploited by the handheld CMOS devices due to the low supply voltage. A solution has been proposed to overcome this problem where one bit information is transmitted by a burst of UWB carrier pulses. This contribution determines the optimum value of delay to be set between two successive UWB pulses.

2. Allocated Frequency Band and Bandwidth for UWB Radio

The frequency band allocated to handheld UWB radio devices goes from 3.1 GHz up to 10.6 GHz. The UWB bandwidth is defined by the frequency band that is bounded by the frequencies $f_H > f_L$ where the power spectrum of radiated signal is 10 dB below the peak value.

By definition, the fractional bandwidth is given by

$$BW_{frac} = 2 \frac{f_H - f_L}{f_H + f_L} \quad (1)$$

A UWB transmitter is an intentional radiator that has (i) a fractional bandwidth $BW_{frac} \geq 20\%$, or (ii) a UWB bandwidth $f_H - f_L \geq 500$ MHz, regardless of the fractional bandwidth.

The only IEEE Standard already approved for the UWB impulse radio was elaborated by the IEEE 802 LAN/MAN Standards Committee as an amendment to IEEE 802.15.4–2006 in 2007 [2].

3. Carrier of UWB IR Devices

Because of its easy implementation with CMOS technology [3], easy mathematical handling and IEEE Standard 802.15.4a [2] compliance the frequency-shifted gaussian pulse is considered here as UWB IR carrier pulse:

$$g(t) = p(t) \cos(\omega_c t) = \sqrt{\frac{2Z_0 E_b}{k \sqrt{\pi} u_B}} \exp\left(-\frac{t^2}{2u_B^2}\right) \cos(\omega_c t) \quad (2)$$

where $p(t)$ is the lowpass gaussian envelope, $f_c = \omega_c/2\pi$ is the center frequency of the gaussian pulse, Z_0 is the characteristic impedance over which E_b is measured and u_B is determined by the required 10-dB RF bandwidth $2f_B$ of UWB wavelet

$$u_B = \frac{1}{2\pi f_B \sqrt{\log_{10}(e)}} \quad (3)$$

To increase the radio coverage, one bit information is transmitted by a burst of UWB carrier pulses [3]. Parameter k in (2) gives the number of UWB pulses used to carry one bit information. In the remaining part of the contribution, $g(t)$ is referred to as UWB carrier pulse.

The *peak pulse amplitude* is obtained from (2) as

$$V_{peak} = \sqrt{\frac{2Z_0 E_b}{k \sqrt{\pi} u_B}} \quad (4)$$

The idea of effective pulse width, introduced in spectrum analysis [4], is used to characterize the UWB pulse duration

$$\tau_{eff} = \int_{-\infty}^{+\infty} \frac{p(t)}{V_{peak}} dt = \sqrt{2\pi} u_B = \frac{1}{f_B \sqrt{2\pi \log_{10}(e)}} \quad (5)$$

4. Derivation of Peak Pulse Amplitude

4.1. Interpretation of FCC Peak Power Limit

According to the FCC Regulations [1], the peak power level of UWB emission has to be measured within a 50-MHz bandwidth centered on the frequency at which the highest radiated emission occurs.

The frequency-shifted gaussian pulse (2) achieves its highest emission at the carrier frequency ω_c . Let an isotropic radiator be used at the UWB transmitter and consider an RF bandpass filter characterized by its impulse response $h(t)$.

The test configuration defined in the FCC Regulations is shown in Fig. 1 where the bandwidth and center frequency of the RF

bandpass filter are $RBW_{50}^{FCC} = 50$ MHz and ω_C , respectively. The RF bandpass filter is excited by the UWB pulse $g(t)$. To establish the relationship among the FCC Regulations, V_{peak} and E_b , the peak power at the filter output has to be found.

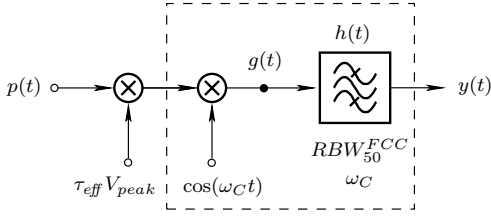

Figure 1: Calculation of the peak power level in the RF domain. The RF bandpass filter defined by the FCC Regulations is characterized by its impulse response $h(t)$.

Let the frequency-shifted Gaussian pulse $g(t)$ in Fig. 1 be expressed as the product of three terms

$$g(t) = [\tau_{eff} V_{peak}] p(t) \cos(\omega_C t) \quad (6)$$

where τ_{eff} and V_{peak} are defined by (5) and (4), respectively, and $p(t)$ is a gaussian function can be easily expressed from (2) as

$$p(t) = \sqrt{\frac{2Z_0 E_b}{k \sqrt{\pi} u_B}} \exp\left(-\frac{t^2}{2u_B^2}\right) \quad (7)$$

Consider the subcircuit included in the dashed box in Fig. 1. To get the simplest model, the RF bandpass filter is substituted by its lowpass equivalent [5] as shown in Fig. 3 where

$$\tilde{h}(t) = h_I(t) + jh_Q(t)$$

denotes the complex impulse response of the RF bandpass filter.

The only duty of the RF bandpass filter depicted in Fig. 1 is to limit the bandwidth of $g(t)$ according to the FCC Regulations, consequently, even an ideal RF bandpass filter can be used. Then $h_Q(t) = 0$ and the complex impulse response of lowpass equivalent of RF bandpass filter takes the form [5]

$$\tilde{h}(t) = h_I(t) = 4B \text{sinc}(RBW_{50}^{FCC} t) \quad (8)$$

The choice of an ideal RF bandpass filter does not restrict the validity of the lowpass equivalent model but simplifies it considerably because the two blocks characterized by the impulse response $h_Q(t)$ in Fig. 3 can be canceled.

The lowpass equivalent can be simplified further if the circuits included in the dashed and dotted boxes in Fig. 3 are merged. Consider the dashed box first that contains two multipliers, a lowpass filter and an amplifier with a gain of 2. The equivalent transfer function of these circuits is equal to 1. Similarly, the equivalent transfer function of the circuits that are involved in the dotted box is equal to 0.

The derived lowpass equivalent model of the peak power calculation is shown in Fig. 2, where the complex impulse response of the lowpass filter is given by (8). Note, the cutoff frequency of equivalent lowpass filter is 25 MHz, the half of the RF bandwidth of RF bandpass filter specified in the FCC Regulations.

The two models shown in Figs. 1 and 2 are equivalent in the sense that their inputs $p(t)$ and outputs $y(t)$ are identical. The peak power limited by the FCC Regulations can be also determined by means of the lowpass equivalent model. Then the relationship among the FCC regulations and the peak pulse amplitude V_{peak} and UWB bit energy E_b , must known parameters for the circuit

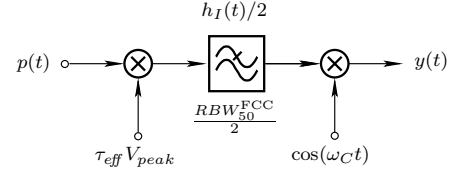

Figure 2: Lowpass equivalent of the peak power level calculation.

designers and system engineers, respectively, can be established.

The excitation $p(t)$, applied to the input of lowpass equivalent model, is a gaussian nascent function that implements a delta function provided that $\sqrt{2}u_B \rightarrow 0$. From an engineering point of view this condition is satisfied when the bandwidth of the gaussian nascent function $p(t)$ is much larger than that of the equivalent lowpass filter. This condition is always satisfied in UWB IR systems since $f_B \gg RBW_{50}^{FCC}$.

If the excitation $p(t)$ in Fig. 2 can be considered as a unit impulse function then the output of the lowpass equivalent filter is nothing else as its impulse response $h_I(t)/2$ and the output of the RF bandpass filter defined by the FCC Regulations is obtained as

$$\begin{aligned} y(t) &= \frac{\tau_{eff} V_{peak}}{2} h_I(t) \cos(\omega_C t) \\ &= RBW_{50}^{FCC} \tau_{eff} V_{peak} \text{Sinc}(RBW_{50}^{FCC} t) \cos(\omega_C t) \end{aligned} \quad (9)$$

Note, except a weighting factor $\tau_{eff} V_{peak}$, $y(t)$ is equal to the impulse response of the filter defined in the FCC Regulations.

Let the RF bandpass filter be terminated by Z_0 ohms. The peak power is measured at $t = 0$ s and is obtained as

$$P_{peak}^{FCC} \equiv \{0 \text{ dBm EIRP}\} = \frac{y(0)^2}{Z_0} = (RBW_{50}^{FCC} \tau_{eff})^2 \frac{V_{peak}^2}{Z_0} \quad (10)$$

5. Derivation of Specification for UWB Circuits

Each UWB transceiver contains many circuits from the transmit power amplifier to the low-noise preamplifier. To develop these circuits, the voltage swings caused by the UWB carrier pulse and the specification for their frequency responses have to be known.

5.1. An Important Property of UWB Circuits

The model shown in Fig. 2 highlight a very important and unique property of UWB circuits that cannot be neglected. The conventional communication circuits almost always operate in steady-state, the transient responses of the circuits are generally neglected. The situation is very different in UWB impulse radio where extremely short pulses are used as carriers. Since the bandwidth of UWB pulses is large compared to that of the systems or circuits being excited by the UWB pulse, the excitation may be considered as a *unit impulse* function. The response of the excited circuit is equal to its *impulse response*, consequently, the transient response of excited circuit cannot be neglected.

5.2. Required Peak Pulse Amplitude

The peak pulse amplitude determines the linearity requirements and the required supply voltage that is crucial in handheld and mobile LR-WPAN/WLAN applications.

Equation (10) establishes the relationship between the FCC Regulations and the peak pulse amplitude. The paper considers only low-rate UWB systems which are peak power limited [3].

The supply voltage of low-cost, low-power CMOS SoC UWB radio systems is less than 1.5 V. The low supply voltage limits

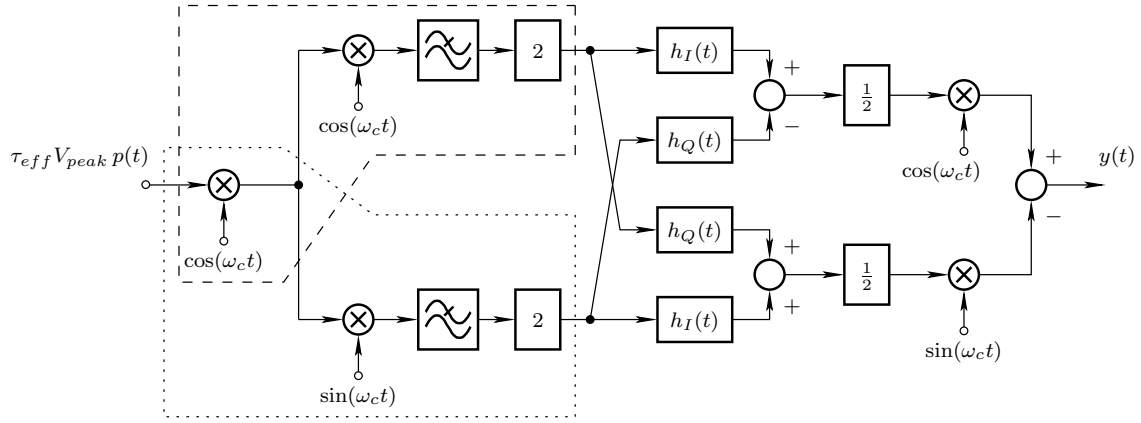

Figure 3: Substitution of the RF bandpass filter by its lowpass equivalent.

the maximum attainable peak-to-peak output voltage swing at the power amplifier output in about 1 V. Therefore, the large peak pulse amplitude allowed by the FCC Regulations cannot be exploited. The low attainable peak pulse amplitude results in a low E_b and, consequently, in a very short radio coverage.

This observation has a serious consequence. The LR UWB IR devices cannot exploit, even theoretically, the FCC peak power limit.

5.3. Reduction of peak pulse amplitude

In the low-rate UWB IR systems the required peak voltage amplitude may be reduced considerably while keeping E_b high enough if more than one UWB carrier pulse is used to transmit one bit information. This solution is shown in Fig. 4 where 5 UWB carrier pulses are used to transmit one bit information. Recall, parameter k appearing in (2) and (4) was introduced to specify the number of UWB pulses used to carry one bit information.

Consider a LR UWB IR device where $k = 5$. Because of the handheld application, let the peak pulse amplitude be limited in 0.5 V as shown in Fig. 4. Note, the time delay t_{delay} elapsed between two successive UWB pulses is a free design parameter that can be exploited to optimize the parameters of UWB transmitter. Let the effect of time delay be studied first.

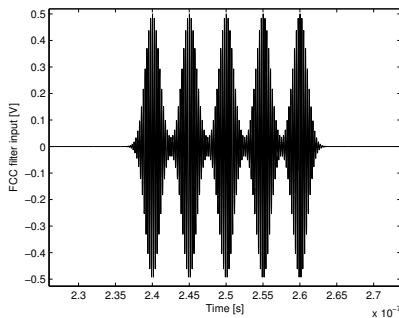

Figure 4: Transmission of one bit using five UWB carrier pulses in a burst.

Figures 5 and 6 plot the FCC filter output when the time delays between the successive UWB pulses are set to $8\tau_{eff}$ and $2\tau_{eff}$, respectively. The FCC peak limit is shown in both figures by dashed curves. The peak pulse amplitudes limited by the supply voltage

are identical in the two cases. Consequently, the two solutions offer the same E_b and same coverage.

Figure 5 shows that if $t_{delay} = 8\tau_{eff}$ then the generated UWB carrier meets the FCC peak power limit with a considerable margin: the interference caused by this UWB transmitter in a conventional receiver remains much below the FCC peak power limit.

If the time delay is reduced to $2\tau_{eff}$ then the UWB transmitter cannot satisfy the FCC peak power limit. As shown in Fig. 6, the interference caused exceeds a bit the allowed peak power limit.

Section 5.1 already emphasized that, contrary to the conventional communication circuits, the transient responses generated by the UWB excitation cannot be neglected. This effect can be observed in Figs. 5 and 6 where both the steady-state and transient responses of FCC filter can be identified. The total duration of transient response is about 2×90 ns, a much larger value than the duration of one UWB pulse.

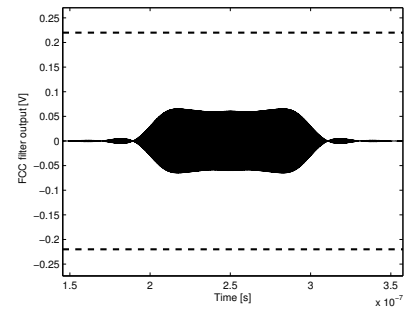

Figure 5: FCC filter output when $k = 5$ and $t_{delay}/\tau_{eff} = 8$. The 1-mW FCC peak power limit is shown by dashed curve.

To find the optimum UWB transmitter configuration, the relationship among the (i) peak pulse amplitude, (ii) time delay between the successive UWB carrier pulses and (iii) number of pulses used to transmit one bit information has to be found.

Let us consider the maximal value of peak pulse amplitude that satisfy the FCC Regulations. Let $V_{peak}^{1 \text{ mW}}$ denote this amplitude. To get the maximal coverage $V_{peak}^{1 \text{ mW}}$ should be maximized. Unfortunately, in many CMOS implementation $V_{peak}^{1 \text{ mW}}$ is limited by the supply voltage.

The relationship among these effects can be observed in Fig. 7 where $V_{peak}^{1 \text{ mW}}$ is plotted against the number k of pulses used to carry one bit information and where the parameter is the normalized de-

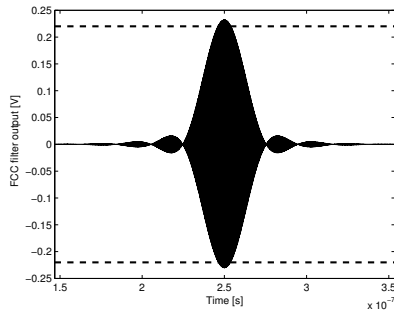

Figure 6: FCC filter output when $k = 5$ and $t_{delay}/\tau_{eff} = 2$. The 1-mW FCC peak power limit is shown by dashed curve.

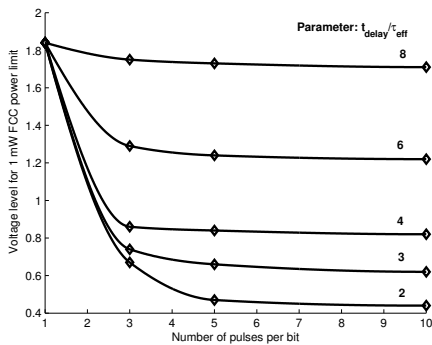

Figure 7: The peak pulse amplitudes of the UWB carrier pulses that belong to the 1-mW FCC peak power limit. The parameter is the normalized time delay t_{delay}/τ_{eff} elapsed between the successive UWB carrier pulses. Its values are 2, 3, 4, 6 and 8 from the bottom to the top.

lay elapsed between two successive UWB pulses. The number k of UWB carrier pulses can take only integer values but in order to get an easy-to-use figure, the values belonging to the same normalized delay are connected by solid curves. Note, if $k \geq 5$ then $V_{peak}^{1\text{ mW}}$ is almost independent of k , but heavily depends on t_{delay}/τ_{eff} .

Let us consider the case when $V_{peak}^{1\text{ mW}}$ is not limited by the supply voltage and $k \geq 5$. The radio coverage depends on $V_{peak}^{1\text{ mW}}$, the higher the $V_{peak}^{1\text{ mW}}$ the larger the coverage. According to Fig. 7, the larger coverage is achieved by $t_{delay}/\tau_{eff} = 8$, where $V_{peak}^{1\text{ mW}}$ achieves its maximal value.

When $V_{peak}^{1\text{ mW}}$ is limited by the supply voltage then the duration of UWB carrier burst becomes a free parameter. Assume that $V_{peak}^{1\text{ mW}}$ is limited in 0.5 V. Figure 7 shows that t_{delay}/τ_{eff} should not be below 3 otherwise the FCC peak power limit is not met.

6. Sensitivity to detuning of center frequencies

The center frequency of FCC filter used to check the peak power limit has to be "centered" on the frequency at which the highest radiated emission occurs" [1]. The center frequency of a UWB carrier burst is equal to the center frequency ω_C of the frequency-shifted gaussian pulses (2).

The UWB carrier pulses are generated by CMOS digital circuits [3], the FCC peak power limit is checked by an LC filter. Both ω_C and the center frequency of an LC filter may deviate from their nominal value. The sensitivity to frequency detuning has to be

determined.

Consider a UWB carrier burst where $k = 5$ pulses are used to carry one bit information. Let the normalized delay between two consecutive UWB pulses set to 2. The effect of detuning is plotted in Fig. 8 where the center frequency, that is equal to 4 GHz, is varied. Note, there is no need for extra precautions since the maximum peak power emission occurs when ω_C coincides with the center frequency of the FCC filter.

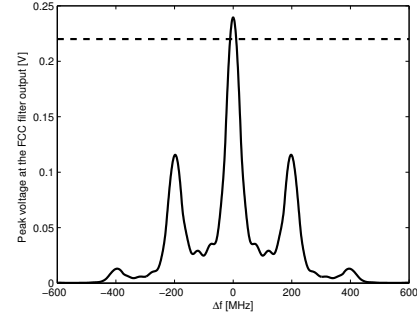

Figure 8: Effect of center frequency detuning on the maximum peak power emission. The frequency axis shows the detuning in MHz, the center frequency is 4 GHz.

7. Conclusions

The low rate UWB impulse radio is peak power limited. Starting from the FCC peak power limit, the paper derived the maximal peak pulse amplitude that determines the coverage of UWB radio. Since the coverage of UWB IR using one carrier pulse is too short, not a single but a burst of UWB impulses is used to carry one bit information. The relationship among the UWB burst parameters and peak pulse amplitude has been determined, the effect of time delay elapsed between two consecutive UWB pulses has been revealed. The sensitivity of frequency detuning has been shown.

8. Acknowledgments

This work has been financed by the Hungarian-Chinese Inter-governmental S&T Cooperation Programme. T. Krébesz's participation was supported by the Mecenatura Fund, National Office for Research and Technology (NKTH), Hungary.

References

- [1] Federal Communications Commission, *Part 15 of the Commission Rules Regarding Ultra-Wideband Transmission Systems; Subpart F*, FCC-USA, Online: <<http://sujan.hallikainen.org/FCC/FccRules/2009/15/>>.
- [2] *IEEE Standard 802.15.4a-2007*, IEEE Computer Society, LAN/MAN Standards Committee, Work Group 15, Task Group 4a, 2007.
- [3] P. P. Mercier, D. C. Daly, M. Bhardwaj, D. D. Wentzloff, F. S. Lee, and A. P. Chandrakasan, "Ultra-low-power UWB for sensor network applications," in *ISCAS'08*, Seattle, Washington, USA, May 18-21 2008, pp. 2562–2565.
- [4] *Spectrum Analysis ... Pulsed RF*, Agilent Technologies, Palo Alto, CA, May 2005.
- [5] S. Haykin, *Communication Systems*, 3rd ed. John Wiley & Sons, 1994.
- [6] K. Witrisal *et al.*, "Noncoherent Ultra-Wideband Systems: An Overview of Recent Research Activities," *IEEE Signal Processing Magazine*, vol. 26, no. 4, pp. 48–66, July 2009.