

# Monopulse Fabry-Perot Resonator Antenna

Zhen-Guo LIU<sup>1</sup>, Yong-Xin GUO<sup>2</sup>

1. State Key Lab. of Millimeter Waves, Southeast University, Nanjing, CHINA, 210096.
2. Department of Electrical and Computer Engineering, National University of Singapore, SINGAPORE, 117576  
[liuzhenguo@seu.edu.cn](mailto:liuzhenguo@seu.edu.cn), [eleguoyx@nus.edu.sg](mailto:eleguoyx@nus.edu.sg)

**Abstract-** In this paper, a monopulse Fabry-Perot resonator (FPR) antenna is presented, which consists of four sub-array as cells, each one is a Fabry-Perot resonator antenna. An assembly Fabry-Perot resonator cell consists of partially reflective surface (PRS) as cover, a metal-dielectric surface as ground plate and an aperture coupled rectangular patch as primary radiator. Taking advantage of highly directional radiation properties and low complexity with single-feed system of Fabry-Perot resonator antenna, the feeding network of proposed monopulse antenna can be simplified easily, compared with traditional microstrip monopulse antenna. The simulation results show that the maximal gain at operating frequency is 23.7 dBi, and the null-depth of the difference pattern are less than -30 dB in both E-and H-Plane.

## I. INTRODUCTION

The monopulse antennas [1-6] are attractive for high-resolution tracking applications and developed in the variety of technologies, which is a key technique for radar angle estimation. In traditional monopulse radar systems, Cassegrain parabolic antennas [7] or lens antennas [8] are commonly applied. The monopulse comparator in such systems composed of metallic waveguide is usually very complicated and heavy. A lightweight and low cost microstrip array structure has been developed for the monopulse antennas. But the complicated feeding network based on microstrip structure will arise the decrease of antenna radiation efficiency.

On the other hand, a high directive emission based on Fabry-Perot resonator antenna generally consists of a primary radiator backed with a metal ground plate and a partially reflective covered plate [9], has also proposed for several years. When the spacing between these two plates is about integer times of half wavelength, the energy from the feed is multi-reflected between the cover and ground plate and then the forward radiation can be enhanced remarkably by means of in-phase bouncing. Their highly directional radiation properties and low complexity with single-feed system allowing the gain to be increased have aroused more and more attention [10-15]. In view point of effective media, Fabry-Perot resonator antenna can be looked as a kind of lens [11, 16, 17]. In some applications, Fabry-Perot resonator antenna can be acted as a sub-array to make up further highly directive antenna array. However, there is less research on this field.

In this paper, by utilizing the advantage of Fabry-Perot resonator antenna, the monopulse antenna with compact structure and with high efficiency is proposed.

## II. DESIGN AND ANALYSIS OF COMPARATOR NETWORK

### A. Principle

As shown in Fig.1, the comparator network consists of four 3 dB directional coupler and four 90° phase shifter. Excited at different input ports, 1-4, the required amplitude and phase excitations can be generated at output ports which connect to four radiators. Thus a two dimensional monopulse performance can be obtained. As known, the bandwidth of two branch line 3dB directional coupler is narrow. The proposed microstrip-based with 3 branch lines 3dB directional coupler is shown in Fig.2. The parameter of directional coupler is list in table 1. All circuits of comparator are integrated in a single Rogers 5880 substrate with the relative permittivity of 2.2 and the thickness of 0.635mm. Figure 3 shows the simulated results of S parameter of proposed directional coupler.

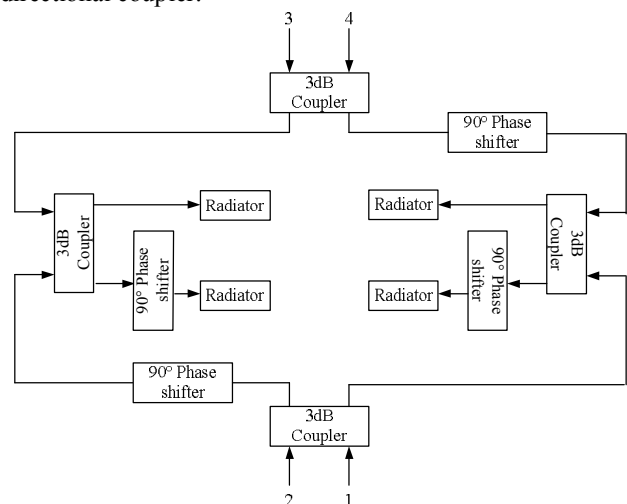

Figure 1. Block diagram of comparator network of monopulse antenna

### B. Design

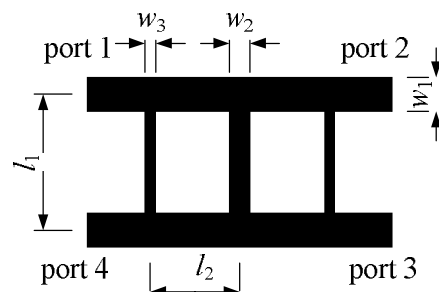
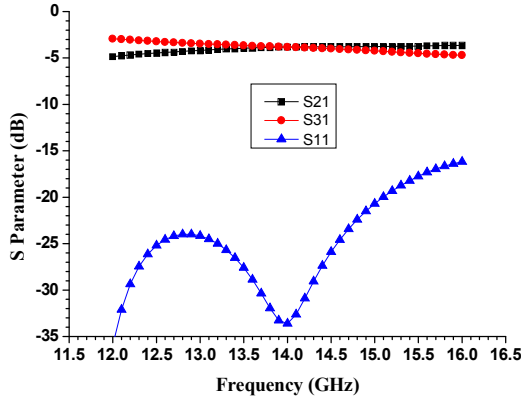

Figure 2. Branch line 3dB directional coupler

Table.1  
Parameter of directional coupler (unit: mm)

$w_1$	$w_2$	$w_3$	$l_1$	$l_2$
1.97	1.14	0.37	5.7	4.67



a

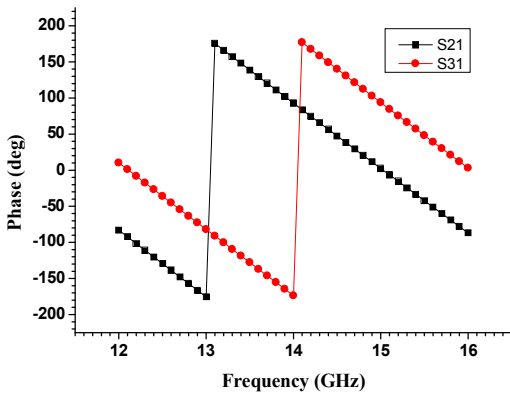

b

Figure 3. S Parameter of Branch line directional coupler (a) amplitude , and (b) phase

In order to obtain two-dimensional performances of the monopulse antenna, the monopulse comparator or sum-difference feed network is proposed. The configuration of whole comparator is shown in Fig.4, which comprised of four 3 dB hybrid couplers and several  $90^\circ$  delay lines. The performance of this comparator was analyzed by HFSS. Excited at different input ports 1-4, the required amplitude and phase excitations can be generated at output ports 5-8. The simulated results of the whole comparator are shown in Fig 5. If the input comes from port 2, the sum beam is then obtained. Meanwhile, if the excitation comes from port 1, the difference radiation pattern will be generated.

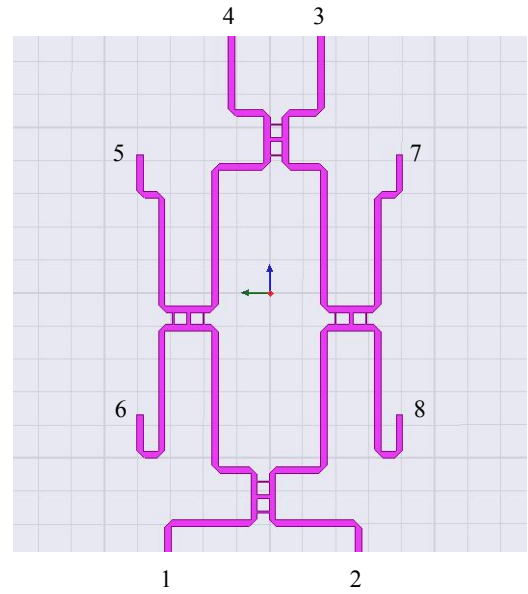
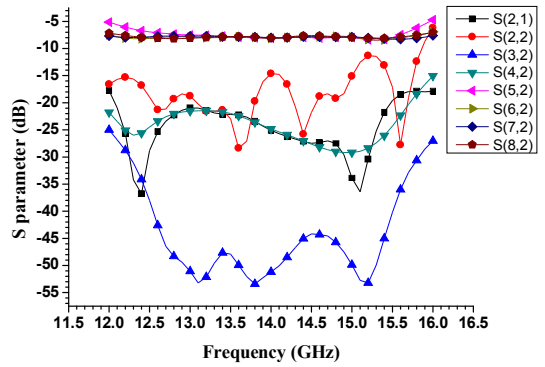
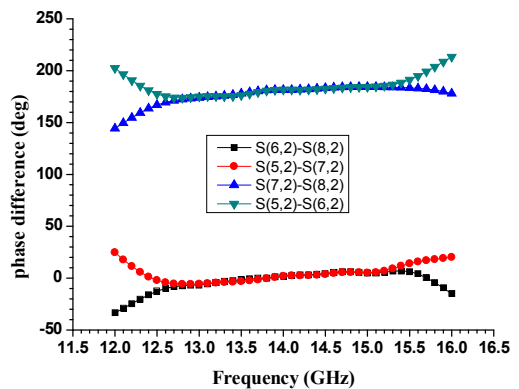

Figure 4. Configuration of whole microstrip comparator



a



b

Figure 5. S Parameter of proposed comparator (a) amplitude of port 2 (b) phase difference

### III. DESIGN AND ANALYSIS OF RADIATOR ELEMENT

The configuration of primary radiator element, aperture coupled microstrip patch antenna, is shown in Fig.6. The radiating microstrip patch element is etched on the top of the antenna substrate, and the microstrip feed line is etched on the bottom of the feed substrate. The fields of microstrip feed line excites the H-shaped aperture etched on the ground plane and then is coupled to the radiating patch. The thicknesses of these two substrates with same dielectric constant are  $t_1$  and  $t_2$ , respectively. The geometry parameters of aperture coupled microstrip patch antenna are listed in table.1. Based on this, a Fabry-Perot resonator antenna fed by aperture coupled microstrip antenna is proposed as shown in figure 7. The square ring shape FSS is printed on the bottom surface of superstrate, which has the distance  $hc$  from the ground plane. The simulation result of S parameter and gain vs frequency of aperture coupled microstrip antenna is shown in figure 8. Figure 9 shows the radiation pattern of E- and H-plane of the proposed Fabry-Perot resonator antenna. The maximum of gain is about 19.5dBi.

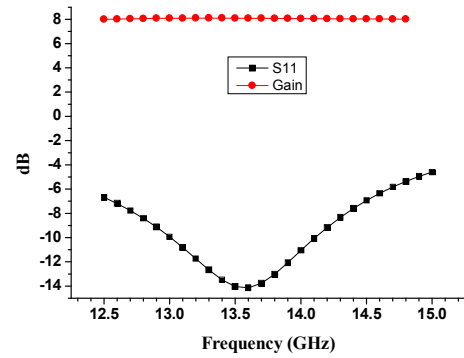

Figure 8. Performance of radiator element aperture coupled patch antenna

TABLE 2  
Value of proposed antenna parameters

Parameter	Dimension (mm)	Parameter	Dimension(mm)
$S_x$	13	$p_x$	8.5
$S_y$	11	$p_y$	6
$sly$	3	$sll$	5
$slw$	1	$w_1$	1.97
$fl$	2.5	$t_1$	0.635
$t_2$	1.575		

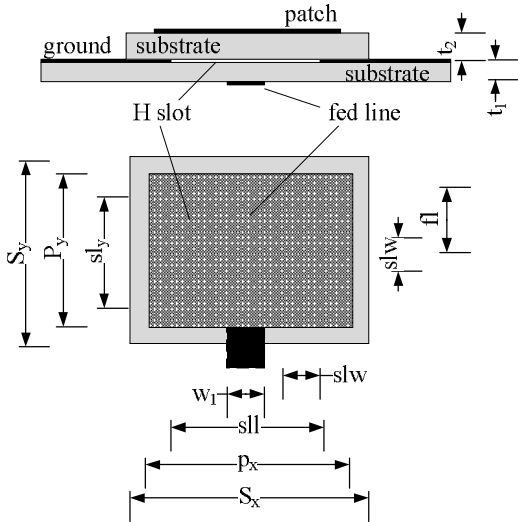

Figure 6. Geometry of primary radiator

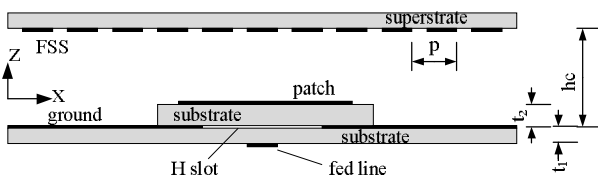

Figure 7. Configuration of Fabry-Perot resonator antenna

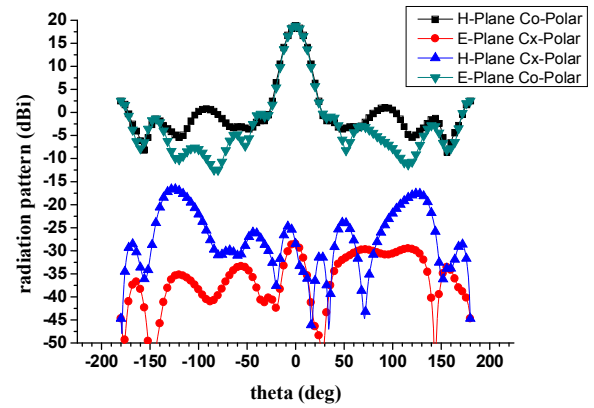

Figure 9. Radiation pattern of Fabry-Perot resonator antenna

#### IV. DESIGN AND ANALYSIS OF MONOPULSE ANTENNA

The monopulse comparator network shown above is integrated with an array of four Fabry-Perot resonator antenna fed by aperture coupled patch, as shown in Figure 10, which makes up of Monopulse Fabry-Perot resonator antenna.

Figure 11 and Figure 12 show the E- and H-plane sum and difference beam of monopulse antenna at frequency 14GHz, respectively. It is demonstrated that the gain of sum beam is achieved to 23.7dBi, whereas the gain of the difference beam is less than 2.82 dB. And the null depth of difference beam are less than -30dB in both plane. The difference pattern also shows a good symmetry.

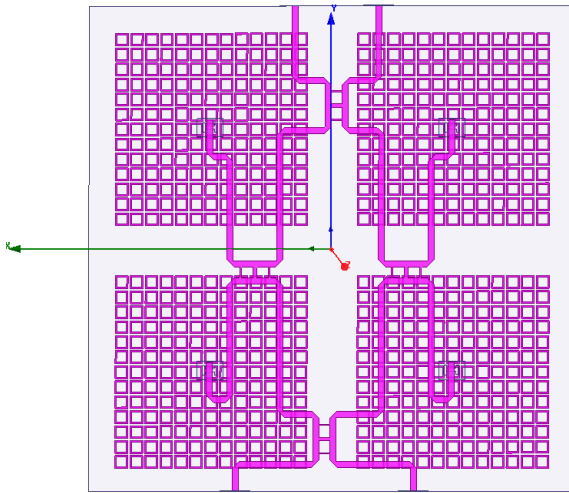

Figure 10. Configuration of proposed Monopulse Fabry-Perot resonator antenna

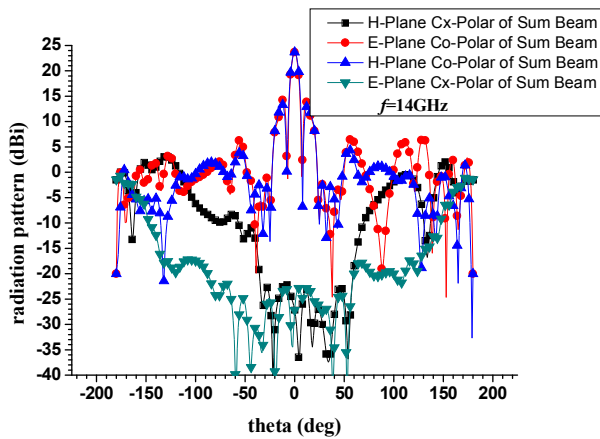

Figure 11. Simulation results of Sum Radiation Pattern @14GHz

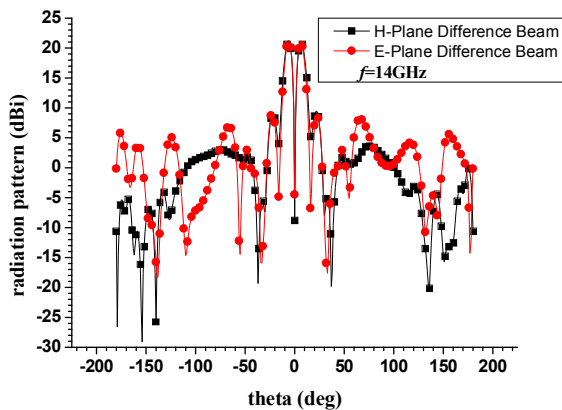

Figure 12. Simulation results of Difference Radiation Pattern @14GHz

## V. CONCLUSION

In this paper, a high gain monopulse antenna consisting of Fabry-Perot resonator antenna acted as sub-array is firstly proposed. Taking advantage of high direction characteristic and single-feed system with low complexity of Fabry-Perot resonator antenna, the feeding network of proposed monopulse antenna can be simplified easily. The simulation results show that the maximal gain at operating frequency is 23.7 dBi, and the null-depth of the difference pattern are less than -30 dB in both E-and H-Plane. This monopulse antenna possesses compact quasi planar architecture, which are particularly suited for airborne applications.

## ACKNOWLEDGMENT

This work is supported by Open Project of State Key Lab. of Millimeter Waves (Z201203)

## REFERENCES

- [1] S.M. Sherman, Monopulse Principles and Techniques. Dedham, MA: Artech House, 1984.
- [2] C.M. Jackson, "Low cost K-band microstrip patch monopulse antenna," *Microwave J.*, vol. 30, no. 7, pp. 125–126, 1987.
- [3] S. G. Kim and K. Chang, "Low-cost monopulse antenna using Bi-directionally-fed microstrip patch array," *Electron. Lett.*, vol. 39, no. 20, 2003.
- [4] M. Sierra-Castaner, M. Sierra-Perez, M. Vera-Isasa, and J. L. Fernandez-Jambrina, "Low-cost monopulse radial line slot antenna," *IEEE Trans. Antennas Propag.*, vol. 51, no. 2, pp. 256–262, Feb. 2003.
- [5] H. Wang, D.G. Fang, "A Compact Single Layer Monopulse Microstrip Antenna Array," *IEEE Trans. Antennas Propag.*, vol. 54, no. 2, pp. 503–509, Feb. 2006.
- [6] Y.J. Cheng, W. Hong, K. Wu, "94 GHz Substrate Integrated Monopulse Antenna Array," *IEEE Trans. Antennas Propag.*, vol. 60, no. 1, pp. 121–129, Jan. 2012.
- [7] F.R. Connor, "New monopulse tracking radar," *Electron. Lett.*, vol. 19, no. 9, pp. 438–440, 1983.
- [8] S. Raman, N.S. Barker, and G.M. Rebeiz, "A W-Band Dielectric-Lens Based Integrated Monopulse Radar Receiver," *IEEE Trans. Microwave Theory and Techniques*, vol. 46, no. 12, pp. 2308–2316, Dec. 1998.
- [9] G.V. Trentini, "Partially reflecting sheet array". *IRE Trans. Antennas Propagat.*, Vol. 4, 1956, pp. 666–671.
- [10] A.P. Feresidis, and J.C. Vardaxoglou, "High-gain planar antenna using optimized partially reflective surfaces". *IEE Proc Microwave Antennas Propagat* Vol. 148, Issue. 6, 2001, pp. 345–350.
- [11] Z.G. Liu, "Fabry-Perot Resonator antenna", *Journal of Infrared Millimeter & Terahertz Waves*, Vol. 31, No. 4, 2010, pp. 391–403.
- [12] Z.G. Liu, W.X. Zhang, D.L. Fu, *et al*, "Broadband Fabry-Perot resonator printed antennas using FSS superstrate with dissimilar size", *Microwave & Opt. Tech. Letters*, Vol. 50, No. 6, 2008. pp. 1623–1627.
- [13] D. R. Jackson and A. Oliner, "A leaky-wave analysis of the high-gain printed antenna configuration", *IEEE Trans. on Antennas Propag.*, vol. 36, No. 7, 1988, pp. 905–910.
- [14] M. Thevenot, C. Cheype, A. Reineix, and B. Jecko, "Directive photonic-bandgap antennas," *IEEE Trans. Antennas Propag.*, Vol. 47, No. 11, 1999, pp. 2115–2122.
- [15] A. Pirhadi, H. Bahrami, and J. Nasri, "Wideband High Directive Aperture Coupled Microstrip Antenna Design by Using a FSS Superstrate Layer", *IEEE Trans. Antennas Propag.*, vol. 60, no. 4, pp. 2101–2105, April, 2012.
- [16] Z.G. Liu, R. Qiang, Z.X. Cao, "A Novel Broadband Fabry-Perot Resonator Antenna with Gradient Index Metamaterial Superstrate", [C], *IEEE Int. Symp. Antennas and Propagation*, 2010, Toronto, Canada.
- [17] Z.G. Liu, "Explanation of broadband Fabry-Perot resonator antenna based on optical viewpoint", [C], *NCMMW2013*, Chongqing, China.