

Circuit implementation and bifurcation analysis of a piecewise-rotational chaotic system for solving optimization problems

Haru Hikita[†] and Yoshikazu Yamanaka[‡] and Tadashi Tsubone[†]

[†]Nagaoka University of Technology

1603-1 Kamitomioka, Nagaoka, Nigata, 940-2188, Japan

[‡]Utsunomiya University

7-1-2 Yoto, Utsunomiya, Tochigi 321-0943, Japan

Email: s153192@stn.nagaokaut.ac.jp, yyamanaka@katzlab.jp, tsubone@vos.nagaokaut.ac.jp

Abstract—In this study, we consider a Piecewise-Rotational Chaotic system (PRC) which is a simple nonlinear discrete-time dynamical system and exhibits chaos. The system is basis of an optimization method named an Optimizer based on Piecewise-Rotational Chaotic system (OPRC) in our previous researches. The previous study has indicated that the system behavior affects search performance. In this paper, as basis of this consideration, we analyze a bifurcation of the system. As result, we provide a bifurcation set of the system. In addition, PRC circuit realization on Field Programmable Analog Array which is a programmable analog IC is proposed. We confirm PRC circuit exhibits chaotic attractors that qualitatively accords with results of a simulation. The result suggests the possibility of realizing OPRCs on chip.

1. Introduction

In engineering field, it is required to quickly search variables close to an optimal solution. There are some practical ways called population-based optimization methods. One of the population-based optimization method is Particle Swarm Optimization (PSO) [1, 2]. PSO searches the optimal solution by the candidates called particles which are located in search space, motivated by the behavior of a swarm such as fishes and birds. The behavior of the particles is determined by the dynamics with stochastic terms.

In our previous study, we have proposed an Optimizer based on Piecewise-Rotational Chaotic system (OPRC) by replacing the dynamics of PSO with chaotic dynamical system called Piecewise-Rotational Chaotic system (PRC). The method uses a simple discrete-time nonlinear system named Piecewise-Rotational Chaotic system (PRC) [3] which exhibits chaos. Previous study of OPRC [3] has evaluated of search performance by using time-series analysis of PRC. Previous study has indicated that the chaotic behavior of PRC affects search performance. However, sufficient analysis of bifurcation phenomena of PRC is not provided. In this paper, as basis of this consideration, we analyze bifurcation of the system.

On other hand, there are some digital circuit implementation of population-based optimization method, such as

circuit implementation of PSO using FPGA [4] and circuit implementation of Genetic Algorithm using FPGA [5]. However, there is not much analog circuit implementation of population-based optimization method. Thus, by implementing OPRC on analog circuits, extending knowledge is expected. To implement OPRC on analog circuits, analog circuit implementation of PRC is needed. Implementing PRC by programmable IC makes easier to change number of particle, dimension of variable and parameters of PRC. In this paper, in addition, we propose PRC circuit realization on Field Programmable Analog Array which is a programmable analog IC. The result suggests the possibility of realizing OPRCs on chip.

2. A Piecewise-Rotational Chaotic system

In this section, we explain PRC. PRC is a discrete time dynamical system that contains two variables $y(t)$, $v(t)$. The dynamics of the PRC is described as follows:

$$\begin{bmatrix} y(t+1) \\ v(t+1) \end{bmatrix} = \begin{cases} \begin{bmatrix} 2\text{Sgn}(y(t))Th - y(t) \\ 0 \end{bmatrix} \\ \text{for } (v(t), y(t)) \in \Pi, \\ R \begin{bmatrix} \cos \theta & \sin \theta \\ -\sin \theta & \cos \theta \end{bmatrix} \begin{bmatrix} y(t) \\ v(t) \end{bmatrix} \\ \text{otherwise,} \end{cases} \quad (1)$$

$$\Pi = \{(v(t), y(t)) \mid |y(t)| > Th, \text{Sgn}(v(t)y(t)) = -1\}, \quad (2)$$

where R , θ , Th are system parameters, and $\text{Sgn}()$ is signum function such as

$$\text{Sgn}(a) = \begin{cases} 1 & a > 0, \\ -1 & a \leq 0. \end{cases} \quad (3)$$

Behavior of the trajectory at time step $t + 1$ is switched whether or not $(v(t), y(t)) \in \Pi$. For $(v(t), y(t)) \notin \Pi$, the trajectory expands distance from the origin into R times and rotates θ with respect to the origin. In contrast, for $(v(t), y(t)) \in \Pi$, the trajectory is folded with resetting. $y(t + 1)$ is mapped the symmetrical point of $y(t)$ with respect to the border of Π , Th or $-Th$, and $v(t + 1)$ sets to 0. Satisfying $R > 1$ and $0 < \theta < \pi/2$ guarantees that the

trajectory must hit Π . Th is the parameter that relate to size of an attractor.

Figure 1,2 and 3 show attractors of PRC at $R = 1.02$, $\theta = 16[\text{deg}]$, $R = 1.12$, $\theta = 16[\text{deg}]$ and $R = 1.25$, $\theta = 16[\text{deg}]$, respectively. Figure. 1 (a), 2 (a) and 3 (a) are y - v planes of results of a simulation. Figure. 1 (b), 2 (b) and 3 (b) are results of a circuit experiment. About Circuit of PRC is described in Sec. 4.1. In the results of simulation, each plots are linked in a line, and shaded areas are indicate $(v(t), y(t)) \in \Pi$.

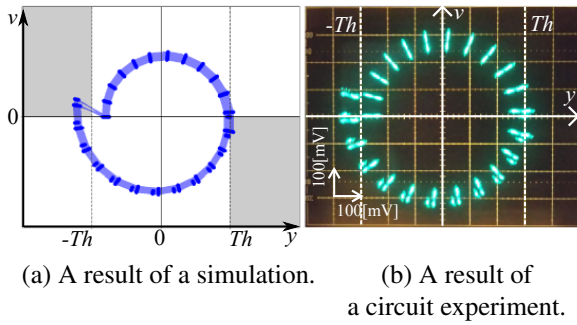

Figure 1: Chaotic attractors of PRC by simulation and circuit at $R = 1.02$, $\theta = 16[\text{deg}]$.

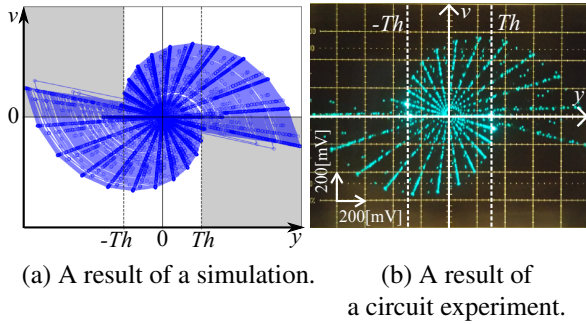

Figure 2: Chaotic attractors of PRC by simulation and circuit at $R = 1.12$, $\theta = 16[\text{deg}]$.

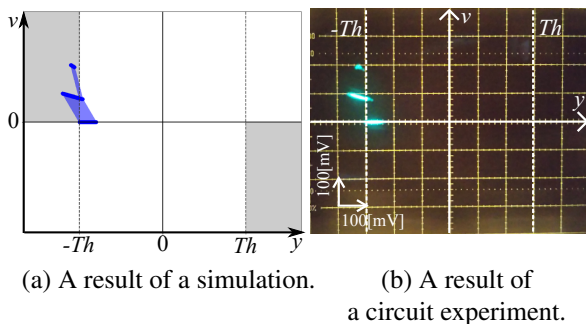

Figure 3: Chaotic attractors of PRC by simulation and circuit at $R = 1.25$, $\theta = 16[\text{deg}]$.

3. Bifurcation of PRC

Previous study shows the PRC exhibits various attractors. In this section, we consider bifurcation phenomena of the PRC.

3.1. 1 parameter bifurcation diagram

In this subsection, we show a 1 parameter bifurcation diagram. The trajectory reaching $(v(T), y(T)) \in \Pi$ at time T ensures $v(T + 1) = 0$. Thus, the trajectory at time $T + 1$ can be considered by only $y(T + 1)$. We show a 1 parameter bifurcation diagram of $y(T + 1)$ in Fig. 4. R is changed in step size 10^{-4} for the range $R \in (1, 1.4]$, and θ is fixed in $16[\text{deg}]$. After calculating 10^4 iterations as transient, 200 points of $y(T + 1)$ are plotted at each parameter in the Fig.4. Parameter R is increased from 1 to 1.4 and initial value of calculation at each R is used last value of calculation at the one before parameter. Parameters indicated A, B and C in Fig. 4 correspond Fig. 1, 2 and 3, respectively. Note that points plotted in Fig. 4 are $y(T + 1)$ mentioned above.

3.2. Bifurcation analysis

Previous study [3] indicates that search performance of OPRC becomes worse at parameters which PRC exhibits an attractor shown as Fig. 3. In this paper, we analyze the bifurcation that appears the attractor. The bifurcation is an interior crisis. In this subsection, we provide the bifurcation set.

Let consider the case of $y > 0$. Similar analysis can be considered as described below in the case of $y < 0$, because PRC is a point symmetric system for the origin.

First, we consider the trajectory that starts from $y_0 \in (0, Th]$, $v_0 = 0$. The trajectory reaches Π after some iterations. Whether the trajectory reaches Π before rotating $\pi/2$ with respect to the origin or not is determined by whether y_0 is larger than the boundary y_k or not. Starting from $y_0 \in (y_k, Th]$, $v_0 = 0$ ensures that the trajectory

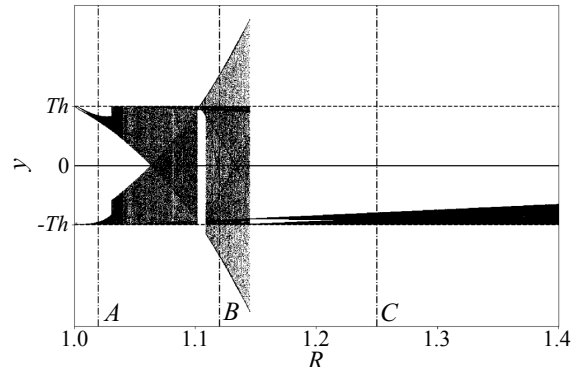

Figure 4: A 1 parameter bifurcation diagram of the PRC for the range $R \in (1, 1.4]$ and $\theta = 16[\text{deg}]$.

reaches Π before rotating $\pi/2$. Next, we consider the trajectory that starts from $y_0 \in (y_k, Th]$, $v_0 = 0$ and reaches Π at time T . Considering at $T + 1$, a maximum value of the $y(T + 1)$ is a value that is slightly lower than Th . We derive minimum value of the $y(T + 1)$ as y_{min} . If $y_k \geq y_{min}$ is satisfied, the trajectory leaving $y_0 \in (y_k, Th]$, $v_0 = 0$ always reaches $y(T + 1) \in (y_k, Th]$, $v(T + 1) = 0$ and PRC exhibits the attractor shown as Fig. 3. And, if y_{min} is slightly larger than y_k , the crisis occurs. y_k and y_{min} are given as follows.

3.2.1. Deriving y_k

If the trajectory which reaches Π before rotating $\pi/2$ exists, the trajectory leaving $y(0) \in (0, Th]$, $v(0) = 0$ satisfies $y(t) > y(t - 1)$ at least at time $t = 1$. Therefore, parameters have to be satisfied $R \cos \theta > 0$.

Let us consider the trajectory which leaving $y(0) \in (0, Th]$ and $v(0) = 0$ satisfies $y(k) = Th$ and $y(k + 1) \notin \Pi$. Previous study [3] has derived k by R, θ as follows:

$$k = \left\lceil \frac{1}{\theta} \operatorname{atan} \left(\frac{R \cos \theta - 1}{R \sin \theta} \right) \right\rceil, \quad (4)$$

for $R \cos \theta > 1$, where $\lceil \cdot \rceil$ is the ceiling function described as $\lceil r \rceil = \min \{m \in \mathbb{Z} | m \leq r\}$, where r is real number and m is an integer.

The trajectory that has initial condition $y(0) = y_k$, $v(0) = 0$ satisfies $y(k) = Th$. Thus, y_k describes as follows:

$$y_k = \frac{Th}{R^k \cos(k\theta)}. \quad (5)$$

3.2.2. Deriving y_{min}

To derive y_{min} , let us consider the trajectory leaving $y_0 \in (y_{min}, Th]$ hits Π at time T . If a maximum value of $y(T)$ is given, we can derive y_{min} . Because $y(T + 1)$ is mapped the symmetrical point of $y(T)$ with respect to Th . To reach the maximum value of $y(T)$, the trajectory must satisfy $y(T - 1) = Th$, $v(T - 1) < 0$. Therefore, $y(T)$ can describe as follows:

$$y(T) = R \cos \theta Th + R \sin \theta v(T - 1). \quad (6)$$

From $0 < \theta < \frac{\pi}{2}$, $\sin \theta > 0$ is given, then $v(T - 1) = 0$ maximizes $y(T)$. y_{min} is given as symmetrical point of the maximum value of $y(T)$ with respect to Th and derived as follows:

$$y_{min} = 2Th - ThR \cos \theta. \quad (7)$$

3.2.3. The bifurcation set

From Eq. 5 and Eq. 7, we can derive the condition that PRC exhibits the attractor shown as Fig. 3 as $y_k \geq y_{min}$ and the boundary set I as follows:

$$I = \left\{ R, \theta \mid \frac{1}{R^k \cos(k\theta)} + R \cos \theta - 2 = 0, R \cos \theta > 1 \right\}. \quad (8)$$

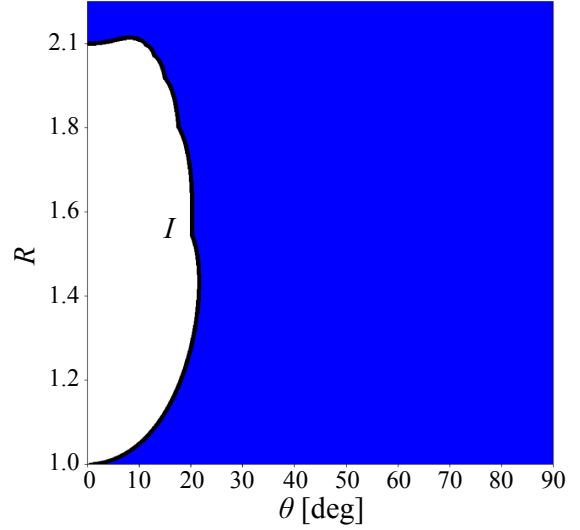

Figure 5: A 2 parameter bifurcation diagram. An area colored white indicates PRC exhibits an attractor as Fig. 3. A curve line I indicates bifurcation set described as Eq. 8.

3.3. 2 parameter bifurcation diagram

Figure 5 shows a 2 parameter bifurcation diagram. R is changed in step size 5×10^{-3} for the range $R \in (1, 2.1]$, and θ is changed in step size $0.5[\text{deg}]$ for the range $\theta \in (0, 90)[\text{deg}]$. After calculating 10^5 iterations as transient, 2000 iteration of $y(t)$ are evaluated sign of $y(t)$ at each parameter in the Fig. 4. Initial value of each calculation are given $y(0) = Th$, $v(0) = 0$ at each parameter. A meaning of color in the Fig. 5 is whether sign of $y(t)$ changes or not in numerical calculation at each parameter. A blue (dark) area indicates sign of $y(t)$ changes at least one time. A white area in the Fig. 5 corresponds to parameters that PRC exhibits the attractor shown as Fig. 3, because sign of $y(t)$ do not change in the attractor like as Fig.3. A Curve line in the Fig. 5 indicates the bifurcation set described as Eq. 8. The result of numerical calculation accords the bifurcation set provided as Eq. 8.

4. Circuit implementation

In above, we considered a bifurcation of PRC. In this section, we propose circuit implementation of PRC on Field Programmable Analog Array (FPAA) and suggest implementation of OPRC using the implemented circuit.

4.1. Circuit implementation of PRC

Figure 6 shows a circuit diagram of PRC. Figure 6 (a) shows a circuit diagram which calculate $y(t+1)$ and $v(t+1)$ from $y(t)$ and $v(t)$. The part surrounded with a dotted line is sample and hold circuit. A state of $SW1$ switches by a sign of $y(t)$, and it is facilitated by circuit as shown in Fig. 6(b). A state of $SW2$ switches by whether $(v(t), y(t)) \in \Pi$ or not.

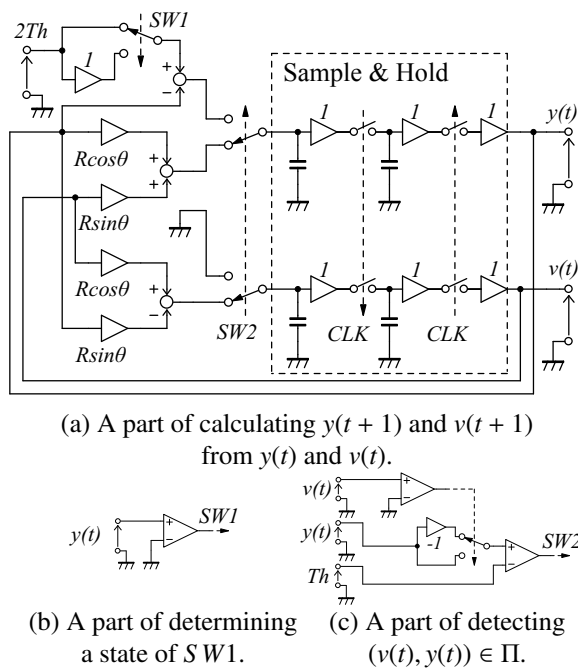

Figure 6: A circuit diagram of PRC.

Discriminating $(v(t), y(t)) \in \Pi$ by circuit is facilitated as Fig. 6(c).

Implementing the circuit of PRC shown in Fig. 6, we use Field Programmable Analog Arrays (FPAA). FPAA is a programmable analog IC and can be implement various analog circuits such as amplifier circuit, added circuit, switch, etc., by using switched capacitor, operational amplifier, and comparator.

Attractors of circuit experiments are shown in Fig. 1 (b), 2 (b) and 3 (b). Shown in Fig. 1 (a), 2 (a) and 3 (a) are the results of a simulation at same parameter. We confirm that PRC exhibits attractors which accord with results of simulations by implemented circuit.

4.2. Implementation of OPRC on PRC circuit

In this subsection, we provide a outline of OPRC implementation. Figure 7 shows architecture of implementation of OPRC using PRC circuits. PRC_i shown in Fig.7

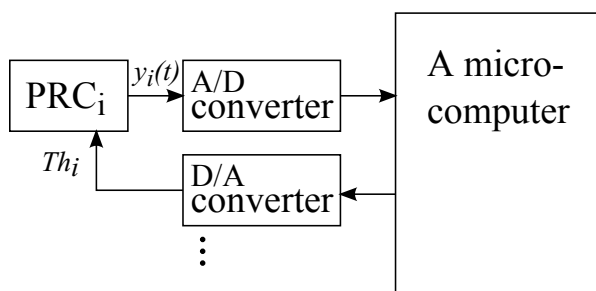

Figure 7: Architecture of implementation of OPRC using PRC circuit.

is PRC circuit which shown in Fig. 6, where i is an index of PRC, $i \in 1, 2, \dots, N$, and N is number of PRC circuits. $y_i(t)$ is $y(t)$ of PRC_i and is converted into a digital value by A/D converter from an analog voltage. A microcomputer calculates $x_i(t)$ from a digital value of $y_i(t)$, a value of a candidate in search space, evaluates a candidates, stores the best value of each candidates and the best value of all candidates and renews Th_i . Th_i is converted into an analog voltage from a digital value and is input to PRC_i from D/A converter. Operations described above are performed every period of PRC.

Although the implementation contains a microcomputer that computes, a part of updating search point is implemented by analog circuit.

5. Conclusion

In this paper, we confirmed the Bifurcation of PRC by a 1 parameter bifurcation diagram. The bifurcation that appear the attractor shown as Fig. 3 was analyzed and the Bifurcation set was derived.

In addition, PRC was implemented on FPAA. Attractors qualitative accorded results of a simulation were obtained by the implemented circuit. The result suggests the possibility of realizing OPRCs on chip.

Evaluation of search performance of OPRC using PRC circuits is a future work.

References

- [1] J. Kennedy and R. Eberhart, "Particle swarm optimization," Proceedings of IEEE international conference on neural networks, vol 4, pp.1942-1948, Dec. 1995.
- [2] R. Eberhart and J. Kennedy, "A new optimizer using particle swarm theory," Proceedings of the International Symposium on Micro Machine and Human Science, pp.39-43, Oct. 1995.
- [3] Y. Yoshikazu and T. Tadashi, "Analysis of an optimizer based on piecewise-rotational chaotic system," Non-linear Theory and Its Applications, IEICE, Vol.7, No.4, pp. 557-575, Oct. 2016.
- [4] G. Grover and I. Chaudhary, "Implementation of Particle Swarm Optimization Algorithm in VHDL for Digital Circuits Optimization," International Journal of Information Engineering and Electronic Business .pp. 16-21, May 2014.
- [5] Skliarove I. and Ferrari A. B., "FPGA-Based Implementation of Genetic Algorithm for the Traveling Salesman Problem and Its Industrial Application," Lecture Notes in Computer Science, vol 2358, June 2002.