

# Stochastic Resonance in an Ensemble of Single-Electron Neuromorphic Devices and its Application to Competitive Neural Networks

Ryo Kagaya, Takahide Oya, Tetsuya Asai, and Yoshihito Amemiya

Graduate School of Information Science and Technology, Hokkaido University  
Kita 14, Nishi 9, Kita-ku, Sapporo 060-0814, Japan,  
Email: {kagaya, oya, asai, amemiya}@sapiens-ei.eng.hokudai.ac.jp

**Abstract**—Neuromorphic computing based on single-electron circuit technology is gaining prominence because of its massively increased computational efficiency and the increasing relevance of computer technology and nanotechnology [1, 2]. The maximum impact of these technologies will be strongly felt when single-electron circuits based on fault- and noise-tolerant neural structures can operate at room temperature. In this paper, inspired by stochastic resonance (SR) in an ensemble of spiking neurons [3], we propose our design of a basic single-electron neural component and report how we examined its statistical results on a network.

## 1. Introduction

In this paper, motivated by the excellent noise- and fault-tolerance of the nervous systems of living organisms, we propose a novel architecture for single-electron circuits that use thermal noises for neural computation.

A single-electron circuit is one that creates electronic functions by controlling movements of individual electrons [4]. The circuit uses tunneling junctions, each of which consists of two conductors facing each other very closely (statically, they are normal capacitors). Under a low-temperature environment, electron tunneling is governed by the physical phenomenon called the Coulomb blockade where an electron does not tunnel through a junction if the tunneling increases the circuit's electrostatic energy ( $E_c$ ).

To comply with the Coulomb blockade, the capacitance of a tunneling junction must be sufficiently small; e.g., if we use 1 pF of capacitance,  $E_c$  corresponds approximately to 1 mK in temperature. Generally, observing the Coulomb blockade in practical experimental environment (e.g.,  $T \sim 0.1$  K) is difficult because the blockade effect is disturbed by thermal fluctuations. Therefore, elemental devices of single-electron circuits; i.e., tunneling junctions and capacitors, must be constructed in nanoscopic scale (lower than a few tens of nano meters).

Recent progress in nanotechnology has accelerated advances in nanoscale processing; e.g., elemental logic gates and memory cells for single-electron LSIs have been proposed in the literature, and reports of their fabrication have appeared. However, many problems still exist for practical use of single-electron circuits. The purpose of this work

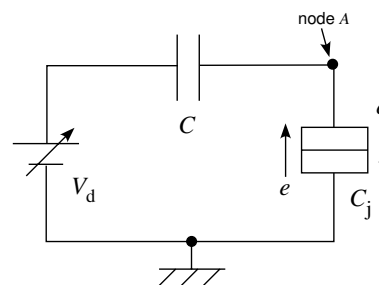

Figure 1: Construction of single-electron box.

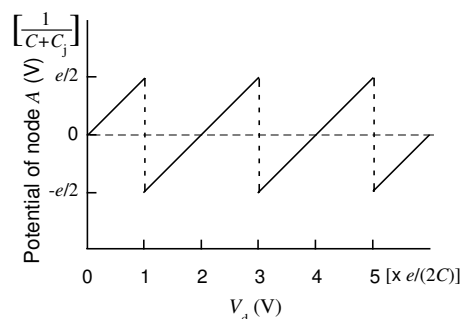

Figure 2: Transient response of single-electron box.

is finding a way to cancel the effects of thermal fluctuations in terms of circuit architecture, instead of improving nanoscale processing. Here we employ biological computing architecture found in nature, for error compensation, instead of conventional deterministic computing architecture, because every living thing uses thermal noises to perform robust and fault-tolerant information processing in natural environments. Oya *et al.* proposed a single-electron competitive neural network and demonstrated that the network operated correctly when  $T \leq 1$  K [5]. In this paper, we propose a single-electron neural circuit that can operate at high temperature by exploiting stochastic resonance (SR) in an ensemble of spiking neurons [3].

## 2. Neuron Circuit with Single-Electron Box

In this work, we use a single-electron box [4] as a neuron. Figure 1 is a schematic presenting the basic construction of a single-electron box that consists of the tunneling

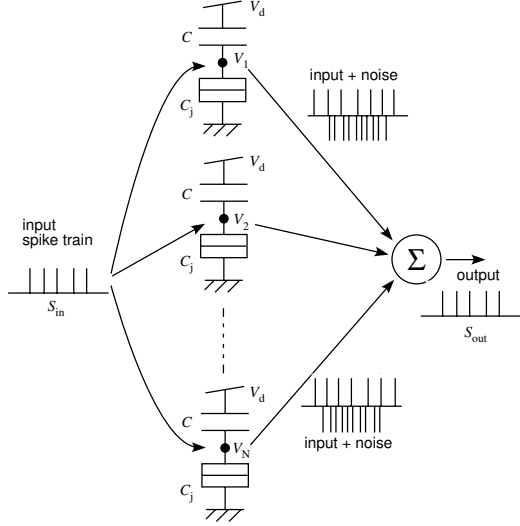

Figure 3: Summing network of  $N$  single-electron boxes.

junction  $C_j$  and biasing capacitor  $C$ . When bias voltage  $V_d$  is increased, an electron tunnels junction  $C_j$  from the ground to node  $A$  and the node charges the electron as a floating (excess) electron that is not cancelled by background positive ions of the device material.

In a low-temperature environment where electron tunneling is governed by the Coulomb blockade effect, electrons are charged at node  $A$  so that the free energy of a circuit is minimized. The number of the electrons is represented by a staircase function of bias voltage  $V_d$ , and is changed discontinuously at

$$V_d = \frac{(n \pm 1)e}{2C}, \quad (1)$$

where  $e$  represents the charge of an electron. As a result of increasing and decreasing the number of electrons, the saw-wave characteristic of potential is observed at node  $A$  for increasing  $V_d$  (Fig. 2).

In a high-temperature environment, where the Coulomb blockade effect is disturbed by thermal fluctuations, electrons tunnel the junction randomly with the following rate

$$\Gamma = \frac{1}{e^2 R_T} \frac{\Delta E}{1 - \exp(-\Delta E/k_B T)}, \quad (2)$$

where  $\Delta E$  represents the difference of electrostatic energy in the circuit (decrease of the energy by the electron tunneling),  $R_T$  the junction resistance,  $k_B$  the Boltzmann constant, and  $T$  the temperature. By increasing the temperature, the rate increases exponentially, which enables electrons to tunnel the junctions even when  $\Delta E < 0$ . This is an obstacle to our designing single-electron circuits based on the Coulomb blockade effect.

Now let us consider an SR among  $N$  single-electron boxes, as illustrated in Fig. 3. When single-electron boxes are not connected to each other, electron tunneling occurs independently in each box's junction. As in the work of

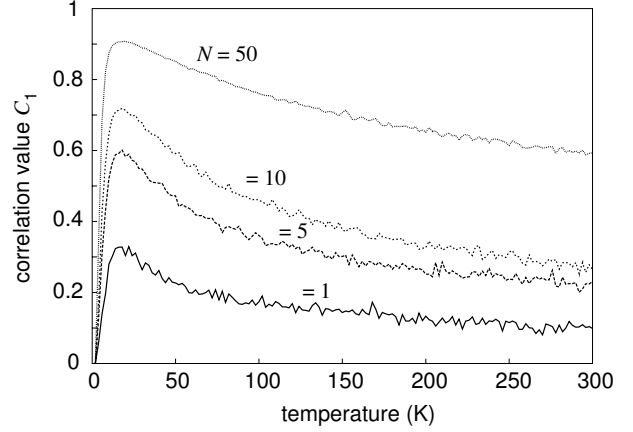

Figure 4: Stochastic resonance in ensemble of single-electron boxes.

Collins *et al.* [3], we apply a common input to all the boxes and calculate the summation of the outputs of all the boxes. For simplicity, we apply a common spike train  $S_{in}$  of frequency  $f$  to all the boxes, and rather than consider practical circuits that calculate the summation of box outputs<sup>1</sup>. The node potential  $V_i$  of the  $i$ -th box is increased by the input spike, while the magnitude of the input is set to a very low value so that no electron tunnels from the ground to the node as a result of this input<sup>2</sup>. Under this condition, increasing the magnitude of thermal noise (temperature) enables electrons to tunnel each junction.

Figure 4 shows simulation results of an ensemble of the single-electron boxes for  $N = 1, 5, 10$  and  $50$  ( $f = 100$  MHz,  $C = C_j = 10$  aF,  $R_T = 1$  M $\Omega$ ). We increased the temperature from 0 to 300K (room temperature), and calculated the following correlation value between the input spikes and the summed output:

$$C_1 = \frac{\langle S_{in} \cdot S_{out} \rangle - \langle S_{in} \rangle \langle S_{out} \rangle}{\sqrt{\langle S_{in}^2 \rangle - \langle S_{in} \rangle^2} \sqrt{\langle S_{out}^2 \rangle - \langle S_{out} \rangle^2}}, \quad (3)$$

where  $S_{out} \equiv \sum_i^N V_i(t)$ . The results revealed characteristic signatures of SR behavior: a rapid rise to a peak, and then a decrease at high temperatures. We observed that the magnitude of  $C_1$  increased as  $N$  increased, as expected. The resonant temperature was approximately 20 K for all the  $N$  values with this parameter set.

Our primary interest here is whether single-electron box neurons can overcome thermal fluctuations with practical physical-parameter sets for tunneling junctions. Contrary to expectations, the correlation value was large, 0.7, even when  $N = 50$ , and it increased as  $N$  increased. Collins *et al.* [3] reported that the correlation value became almost 1

<sup>1</sup>When one attaches the summing circuit, the electron tunneling becomes dependent at each junction because the tunneling rate is represented by a function of "total electrostatic energy" of all the boxes.

<sup>2</sup>In other words, a neuron is stimulated by subthreshold input spikes, if we consider a tunneling phenomenon as a neuron's spike generation.

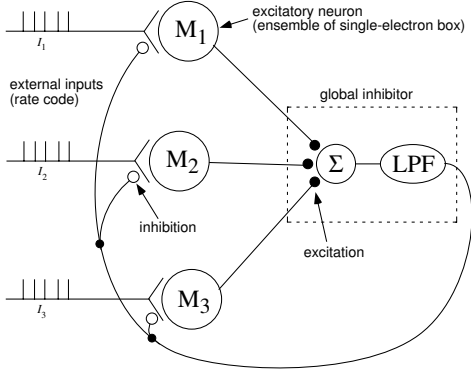

Figure 5: Single-electron competitive neural network.

when  $N = 1000$  independently of the magnitude of noises, which implies that, if we consider an ensemble of the neurons as a transmission line, an input signal is completely transmitted on the line even when the line is fluctuated by extensive noises. Considering this mechanism, we hypothesize a possible architecture for a single-electron circuit that has functions not only a transmission line but also as an intelligent computation where the degree of parallelism increases as  $N$  increases. As the first step, we propose a novel architecture for winner-take-all computation, where a maximum input to the circuit among the external inputs is selected, based on the SR among single-electron boxes.

In this research, we employ a competitive neural network that has inhibitory all-to-all connections between neurons. The basic construction is described in references [5, 6], where  $N$  excitatory neurons excite one inhibitory neuron and the inhibitory neuron (global inhibitor) inhibits all the excitatory neurons. Under this construction, when input spike trains are applied to all the excitatory neurons through excitatory synapses with fixed weight strength, a neuron that receives high-frequency spikes remains activated (winners) but the remainder of the neurons are attenuated significantly (losers). The number of winners increases as the strength of the inhibition decreases.

Figure 5 describes the construction of a competitive neural network consisting of an ensemble of single-electron boxes. Three excitatory neurons ( $M_1$ ,  $M_2$  and  $M_3$ ) and one global inhibitor are presented. Each excitatory neuron consists of an ensemble of  $N$  single-electron boxes, and each box receives a common input spike to a neuron ( $I_i$ ). An output of the neuron is defined by the summation of the box outputs. The global inhibitor performs the summation ( $N$  outputs of the boxes are represented by one axon in Fig. 5). This inhibitor calculates the summation of  $N \times 3$  outputs from all the boxes, and inhibits all the neurons. To maintain the inhibition for short time  $\tau$ , we employ the following inhibitor dynamics

$$\tau \dot{y} = -y + w \sum_i^M \sum_j^N V_{ij}(t) \quad (4)$$

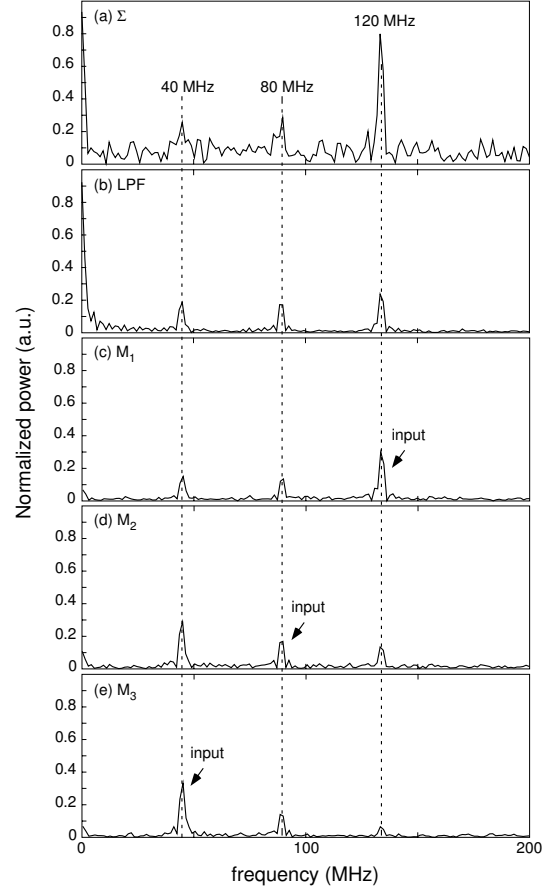

Figure 6: Frequency response of competitive neural network consisting of ensemble of single-electron boxes.

where  $y$  represents the output of the inhibitor,  $w$  the inhibitory connection strength,  $M$  the number of neurons ( $= 3$  in Fig. 5),  $N$  the number of single-electron boxes in each excitatory neuron, and  $V_{ij}$  the node voltage of  $j$ -th box in  $i$ -th excitatory neuron. Shunting inhibition, where the strength of the inhibition is proportional to the amount of  $y$ , decreases the node potential of each neuron.

Results of simulating the single-electron competitive neural network are shown in Fig. 6 (for  $N = 10$ ). Parameter values of all the boxes were the same as the results presented in Fig. 4. We applied input spikes of 120 MHz, 80 MHz and 40 MHz to  $M_1$ ,  $M_2$  and  $M_3$ , respectively. The temperature was set at 20 K where  $C_1$  was the maximum for all  $N$  in Fig. 4. Figures 6(a) and (b) show frequency responses of  $\Sigma$  in Fig. 5 and the LFP output. In both figures, the peak frequency agreed well with that of input spikes (40 MHz, 80 MHz and 120 MHz).

Figures 6(c), (d), and (e) are plots of the frequency responses of  $M_1$ ,  $M_2$  and  $M_3$ , respectively. The peak frequency of  $M_1$  was 120 MHz (c), while that of  $M_2$  and  $M_3$  were 40 MHz (d, e). A neuron that received high frequency spikes (120 MHz) remained activated, while the rest of the neurons that received lower frequency input spikes (40

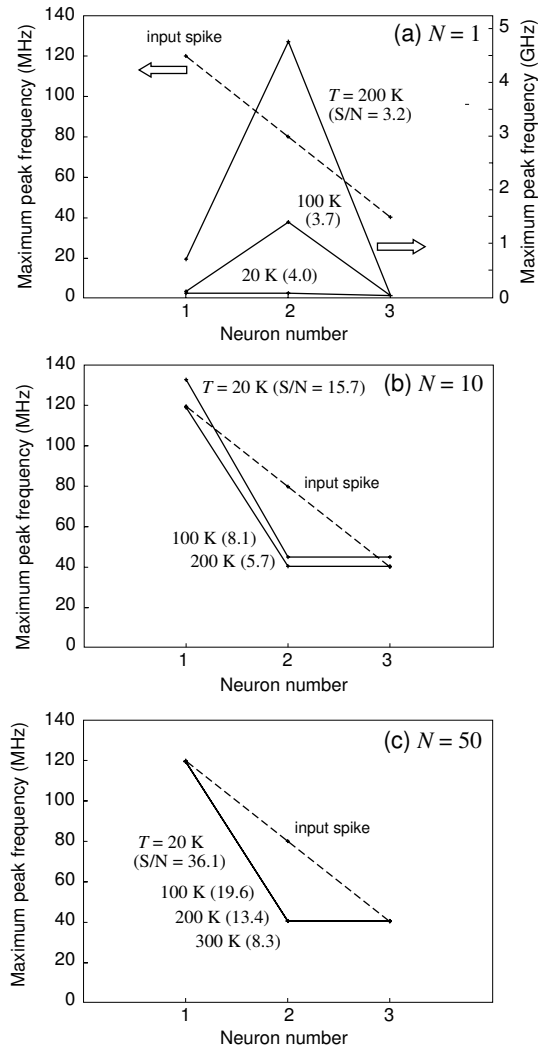

Figure 7: Results of neural competition in ensemble of single-electron boxes.

MHz) were inhibited; this indicates that the three neurons competed with each other correctly even at  $T = 20$  K.

Our next interest is to examine the temperature characteristic of the proposed circuit. Figure 4 suggests that the noise performance increases monotonically as  $N$  increases. Here we define a competitive performance as i) degree of nonlinearity of neuron's outputs for the neuron number where the input spike frequency is linearly increased as the neuron number increases, and ii) ratio of minimum peak power of a winning neuron to the averaged power of the neuron (minimum signal-to-noise ratio in a winning neuron). We examined the competitive performance of the network with  $N = 1, 10$  and  $50$ , for increasing temperature. Figure 7 plots the results.

As shown in Fig. 7(a), when  $N = 1$ ,  $M_2$  received spikes of 80 MHz and survived for the given temperature sets ( $T = 20$  K, 100 K and 200 K), and this means that each neuron competed incorrectly. When  $N = 10$  [Fig. 7(b)],  $M_1$  re-

ceived spikes of the highest frequency (120 MHz), and survived for all the temperature sets, while  $M_2$  and  $M_3$  were sufficiently inhibited. The S/N for  $T = 20$  K was 15.7 and that for 200 K was 5.7. The result for  $N = 50$  is shown in Fig. 7(c); each neuron competed correctly at  $T = 300$  K and the S/N was 8.3. These results prove that, when a single-electron competitive neural network is constructed by exploiting the SR phenomena, the winners and losers at room temperature can be discriminated.

### 3. Summary

We proposed a single-electron competitive neural network based on stochastic resonance (SR) in an ensemble of single-electron boxes that can operate at room temperature. First, using realistic physical parameters, we confirmed the SR behavior of single-electron boxes. The resonant temperature was 20 K, independent of the number of boxes ( $N$ ). Using numerical simulations, we demonstrated that the winners and losers of the SR based network ( $N = 50$ ) can be discriminated even at room temperature.

### Acknowledgments

This study was supported by Industrial Technology Research Grant Program in '04 from the New Energy and Industrial Technology Development Organization of Japan.

### References

- [1] Likharev K. *et al.*, "CrossNets: High-performance neuromorphic architectures for CMOL circuits," *Molecular Electronics III: Annals of New York Acad. Sci.* vol. 1006, pp. 146-163 (2003).
- [2] Oya T. *et al.*, "On the fault tolerance of a clustered single-electron neural network for differential enhancement," *IEICE Electronics Express*, vol. 2, no. 3, pp. 76-80 (2005).
- [3] Collins J. J. *et al.*, "Stochastic resonance without tuning," *Nature*, vol. 376, pp. 236-238 (1995).
- [4] H. Gravert and M. H. Devoret, *Single Charge Tunneling — Coulomb Blockade Phenomena in Nanostructures*, New York: Plenum (1992).
- [5] Oya T. *et al.*, "Neuromorphic single-electron circuit and its application to temporal-domain neural competition," *Proc. 2004 Int. Symp. Nonlinear Theory and its Application*, pp. 235-239 (2004).
- [6] Asai T. *et al.*, "A subthreshold MOS neuron circuit based on the Volterra system," *IEEE Trans. Neural Networks*, vol. 14, no. 5, pp. 1308-1312 (2003).