

IEICE Proceeding Series

Investigation and Analysis of Phase-Inversion Waves in
In-and-Anti-Phase Synchronization on 3D Lattice Oscillators

Shouhei FUJIMOTO, Seiko KUNIHIRO, Masayuki YAMAUCHI

Vol. 2 pp. 467-470

Publication Date: 2014/03/18

Online ISSN: 2188-5079

Downloaded from www.proceeding.ieice.org

Investigation and Analysis of Phase-Inversion Waves in In-and-Anti-Phase Synchronization on 3D Lattice Oscillators

Shouhei FUJIMOTO[†], Seiko KUNIHIRO[†] and Masayuki YAMAUCHI[†]

[†]Department of Electronics and Computer Engineering, Hiroshima Institute of Technology
 2-1-1, Miyake, Saeki-ku, Hiroshima, Japan
 Email: fujimoto.1915@gmail.com

Abstract—In our previous study, we observed and analyzed synchronization phenomena on ladder shape systems and 2D lattice shape systems which are constructed by many oscillators. We discovered a wave which is a phenomenon changing from in-phase to anti-phase synchronization or from anti-phase to in-phase synchronization. We call the phenomenon a phase-inversion wave.

In this study, we observe and analyze phase-inversion waves in in-and-anti-phase synchronizations on 3D lattice shape systems which include many van der Pol oscillators coupled by inductors. We clarify a domain of parameters existing phase-inversion waves, and analyze a propagation mechanism of the phase-inversion wave.

1. Introduction

Nowadays, coupled oscillators systems attract attention from many researchers because the systems can be observed in natural world. For example, many fireflies in south-eastern Asia blink simultaneously [1]. If a firefly is assumed as an oscillator, we think that a group of fireflies can be expressed as a network of coupled oscillators [2]-[3]. Therefore, we can think that the fireflies, which blink simultaneously, synchronize. A beat of the heart, superconductive phenomena and etc. depend on the synchronization phenomena. In other words, researches of coupled oscillator helpful to analyze natural phenomena and to grow industries.

In our previous study, we analyzed synchronization phenomena on ladder shape systems and 2D lattice shape systems which are constructed by many oscillators [4]-[5]. We discovered a phenomenon which switches phase states between two adjacent oscillators from the in-phase to the anti-phase synchronization or from the anti-phase to the in-phase synchronization and continuously propagates. The phenomenon is called a phase-inversion wave.

We can observe that phase states between adjacent oscillators on the 3D lattice are the in-phase synchronization and the anti-phase synchronization alternately. The synchronization state is called an in-and-anti-phase synchronization. In this study, we observe and analyze the phase-inversion waves in the in-and-anti-phase synchronizations on coupled van der Pol oscillators by inductors as a 3D lattice. We clarify a parameter domain of which phase-inversion waves exist. A propagation mechanism of the phase-inversion wave is analyzed by using computer simu-

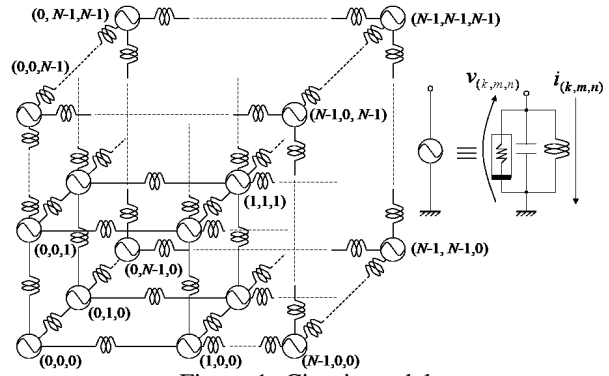

Figure 1: Circuit model.

lations.

2. Circuit model

We show the circuit model of this study in Fig. 1. The van der Pol oscillators are coupled by inductors as a 3D lattice. The numbers of oscillators in x -axis, y -axis or z -axis of this system are assumed as “ N ” respectively. Each oscillator is named as OSC(k, m, n) ($0 \leq k, m$ and $n \leq N-1$). A voltage of each oscillator is named $v_{(k, m, n)}$, and a current flowing a inductor of each oscillator is named $i_{(k, m, n)}$. An equation of the nonlinear negative resistor is shown as Eq. (1). The circuit equations are normalized by Eq. (2), these are shown in Eqs. (3)–(4).

$$i_r(v_{(k, m, n)}) = -g_1 v_{(k, m, n)} + g_3 v_{(k, m, n)}^3. \quad (1)$$

$$i_{(k, m, n)} = \sqrt{\frac{Cg_1}{3Lg_3}} u_{(k, m, n)}, \quad v_{(k, m, n)} = \sqrt{\frac{g_1}{3g_3}} w_{(k, m, n)}, \quad (2)$$

$$t = \tau \sqrt{LC}, \quad \alpha = \frac{L}{L_0}, \quad \varepsilon = g_1 \sqrt{\frac{L}{C}}.$$

[Center] ($0 < k < N$), ($0 < n < N$), ($0 < m < N$)

$$\frac{du_{(k, m, n)}}{d\tau} = w_{(k, m, n)}, \quad (3)$$

$$\begin{aligned} \frac{dw_{(k, m, n)}}{d\tau} = & -u_{(k, m, n)} + \alpha \{u_{(k+1, m, n)} + u_{(k-1, m, n)} \\ & + u_{(k, m+1, n)} + u_{(k, m-1, n)} + u_{(k, m, n+1)} \\ & + u_{(k, m, n-1)} - 6x_{(k, m, n)}\} \\ & + \varepsilon (w_{(k, m, n)} - \frac{1}{3} w_{(k, m, n)}^3). \end{aligned} \quad (4)$$

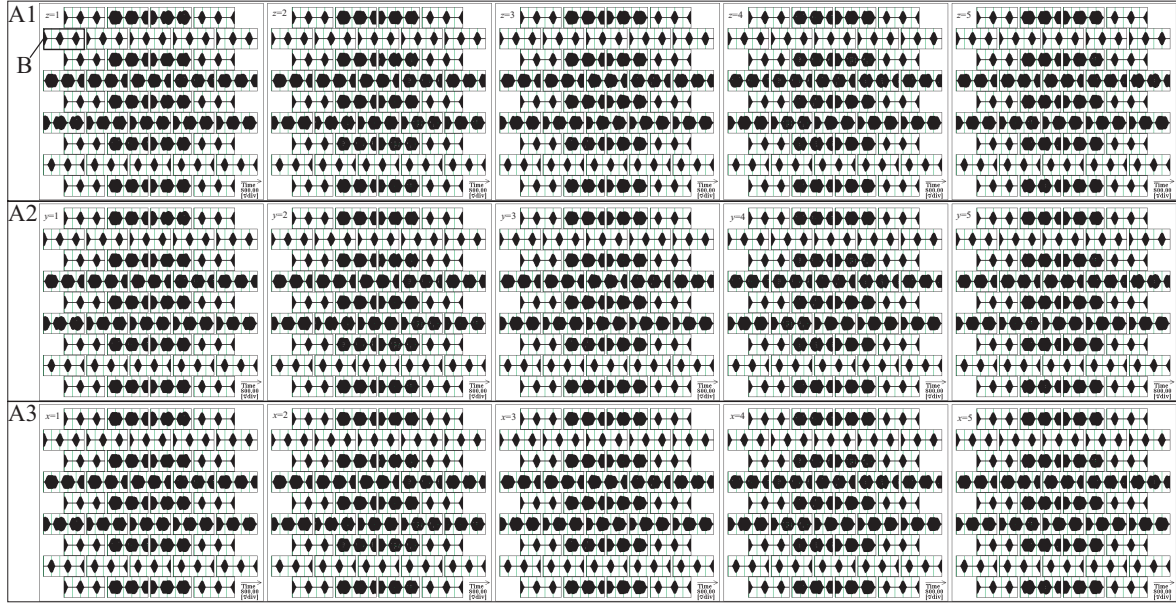

Figure 2: The phase-inversion waves on 3D lattice (A1: x vs y , A2: x vs z , A3: y vs z).

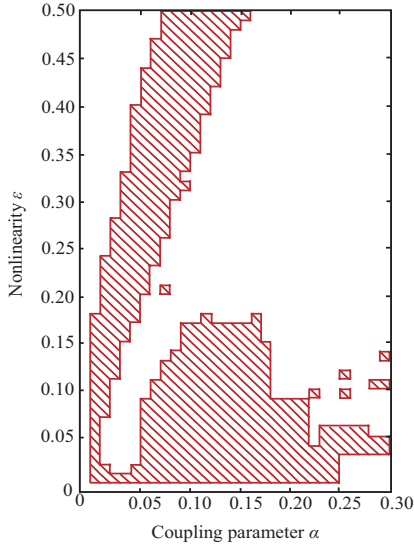

Figure 3: Parameter Domain.

3. Phase-inversion waves on 3D lattice

We observe the phase-inversion waves on 3D lattice when $N=5$. Each cross section of the 3D lattice is observed. Phase states in cross sections are shown in Fig. 2. The cross section is called x - y plane, x - z plane or y - z plane. The phase-inversion waves can be observed in each plane. In the Fig. 2, box A1 shows x - y planes when $z=1, 2, 3, 4$ or 5 , box A2 shows x - z planes when $y=1, 2, 3, 4$ or 5 and box A3 shows y - z planes when $x=1, 2, 3, 4$ or 5 . We can observe the phase-inversion waves in each x column, y column and z column at the same time. Vertical axis of box B in the Fig. 2 shows sum of voltages of adjacent oscillators, and horizontal axis of box B is time.

The domains, which the phase-inversion waves can be observed, are shown in Fig. 3. We investigate the domains when α is changed from 0.01 to 0.30 every 0.01, and ε is changed from 0.01 to 0.50 every 0.01. In the Fig. 3,

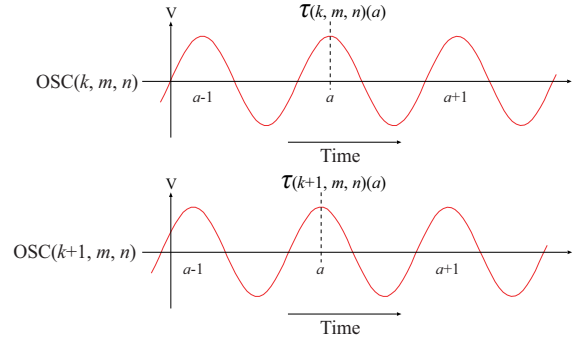

Figure 4: The detection method of the phase difference.

the vertical axis is nonlinearity ε , and the horizontal axis is coupling parameter α . Parts of a shaded area shows area which the phase-inversion waves can be observed.

4. Propagation mechanism of the phase-inversion wave

We can observe some characteristics of the phase-inversion waves in the Fig. 2. There are propagations, reflections at the edges and penetrations. The propagation can be observed in the in-and-anti-phase synchronization in each column. We analyze the mechanism of propagation by using phase differences between adjacent oscillators and instantaneous frequencies.

4.1. Instantaneous frequency

The instantaneous frequency is named $f_{(k,m,n)}(a)$ where “ a ” expresses the number of times of the positive peak value of the voltage (see Fig. 4). Time of a -th positive peak value of the voltage of $OSC(k,m,n)$ is assumed as $\tau_{(k,m,n)}(a)$. Similarly, $\tau_{(k+1,m,n)}(a)$, $\tau_{(k,m,n+1)}(a)$ and $\tau_{(k,m,n+1)}(a)$ are decided. The $f_{(k,m,n)}(a)$ is obtained by Eq. (5).

$$f_{(k,m,n)}(a) = \frac{1}{\tau_{(k,m,n)}(a) - \tau_{(k,m,n)}(a-1)}. \quad (5)$$

In 3D lattice, the number of adjacent oscillators of an oscillator is 6. Therefore, we have to consider 7 patterns of

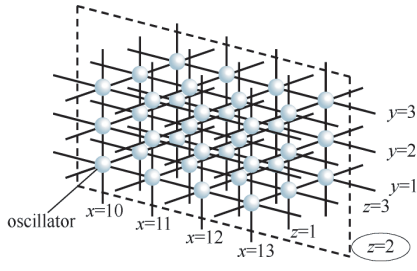

(a) 3D model

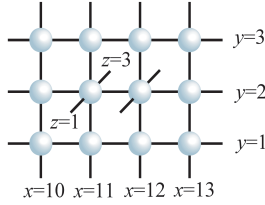

(b) x-y plane (z=2)

Figure 5: A part of the circuit model.

phase states. 1st pattern: six phase states are the in-phase synchronization. 2nd pattern: five phase states are the in-phase synchronization, and a phase state is the anti-phase synchronization. 3rd pattern: four phase states are the in-phase synchronization, and two phase states are anti-phase synchronization. 4th pattern: three phase states are the in-phase synchronization, and three phase states are anti-phase synchronization. 5th pattern: two phase states are the in-phase synchronization, and four phase states are anti-phase synchronization. 6th pattern: a phase state is the in-phase synchronization, and two phase states are the anti-phase synchronization. 7th pattern: six phase states are the anti-phase synchronization. The instantaneous frequencies of the oscillators are called f_{i6a0} , f_{i5a1} , f_{i4a2} , f_{i3a3} , f_{i2a4} , f_{i1a5} and f_{i0a6} respectively.

4.2. Phase difference

A phase difference $\Phi_{(k,m,n)(k+1,m,n)}(a)$ between $OSC(k,m,n)$ and $OSC(k+1,m,n)$, a phase difference $\Phi_{(k,m,n)(k+1,m,n)}(a)$ between $OSC(k,m,n)$ and $OSC(k,m+1,n)$ and a phase difference $\Phi_{(k,m,n)(k,m,n+1)}(a)$ between $OSC(k,m,n)$ and $OSC(k,m,n+1)$ are calculated by Eq. (6) (see Fig. 4).

$$\begin{aligned} \Phi_{(k,m,n)(k+1,m,n)}(a) &= \frac{\tau_{(k,m,n)}(a) - \tau_{(k+1,m,n)}(a)}{\tau_{(k,m,n)}(a) - \tau_{(k,m,n)}(a-1)} \times 2\pi[\text{rad}], \\ \Phi_{(k,m,n)(k,m+1,n)}(a) &= \frac{\tau_{(k,m,n)}(a) - \tau_{(k,m+1,n)}(a)}{\tau_{(k,m,n)}(a) - \tau_{(k,m,n)}(a-1)} \times 2\pi[\text{rad}], \\ \Phi_{(k,m,n)(k,m,n+1)}(a) &= \frac{\tau_{(k,m,n)}(a) - \tau_{(k,m,n+1)}(a)}{\tau_{(k,m,n)}(a) - \tau_{(k,m,n)}(a-1)} \times 2\pi[\text{rad}]. \end{aligned} \quad (6)$$

4.3. Propagation mechanism

The propagation mechanism is shown in Table 1. Each figure of Table 1 shows a cross section of the circuit model, and is explained in Fig. 5. The Fig. 5(a) shows a part of the circuit model. Fig. 5(b) shows x-y plane in Fig. 5(a) when $z=2$. In figures of Table 1, the double lines show that phase states between adjacent oscillators are the anti-phase

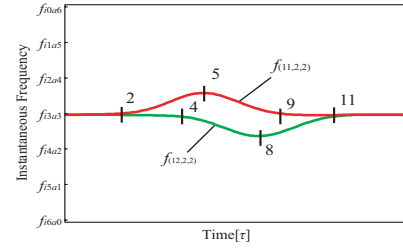

(a) Instantaneous Frequency

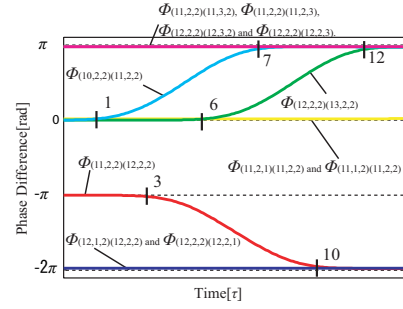

(b) Phase difference

Figure 6: Itinerancies of phase differences and instantaneous frequencies by the propagation of a phase-inversion wave in the in-and-anti-phase synchronization.

synchronizations, the normal lines show the in-phase synchronizations. A y-z plane of $x=0$ is called 0th y-z plane. Itinerancies of instantaneous frequencies and phase differences are shown in Fig. 6. In Fig. 6(a), the vertical axis is instantaneous frequency, and the horizontal axis is time. In Fig. 6(b), the vertical axis is phase difference, and the horizontal axis is time.

5. Conclusion

We discovered the phase-inversion waves in in-and-anti-phase synchronizations on coupled van der Pol oscillators by inductors as a 3D lattice. Parameter domains of existing the phase-inversion waves were made clear. Furthermore, the propagation mechanism of the phase-inversion wave was analyzed by using phase differences between adjacent oscillators and instantaneous frequencies.

References

- [1] J. Buck, "Synchronous rhythmic flashing of fireflies. II," *Quart. Rev. Biol.* vol. 63, no. 3, pp. 265–289, Sep. 1988.
- [2] C. M. Gray, "Synchronous Oscillations in Neuronal Systems: Mechanisms and Functions," *J. Comp. Neuro.* 1, pp. 11–38, 1994.
- [3] I. V. Belykh, E. Lange, M. Hasler, "Synchronization of bursting neurons: What matters in the network topology," *Phys. Rev. Lett.*, 94: 188101, 2005.
- [4] S. Kunihiro, H. Aburatani, M. Yamauchi and Y. Nishio, "Propagation Mechanism of Phase-Inversion Wave in In-and-Anti-Phase Synchronization on 2D Lattice Oscillator," *Proc. of NOLTA2010*, pp. 15–18, Sep. 2010.
- [5] S. Kunihiro, R. Okamoto, H. Aburatani, M. Yamauchi and Y. Nishio, "Actual Circuit Experiments and Computer Simulations of Phase-Inversion Waves in In-and-Anti-Phase Synchronization on 2D Lattice Oscillators," *Proc. of NOLTA2011*, pp. 480–483, Sep. 2011.

Table 1: Propagation mechanism of the phase-inversion wave.

Num	Explain	Figure
0	At this time, $\Phi_{(10,2,2)(11,2,2)}$, $\Phi_{(11,1,2)(11,2,2)}$, $\Phi_{(11,2,1)(11,2,2)}$, $\Phi_{(12,1,2)(12,2,2)}$, $\Phi_{(12,2,1)(12,2,2)}$ and $\Phi_{(12,2,2)(13,2,2)}$ are 0 or π (see Fig. 6). $\Phi_{(11,2,2)(12,2,2)}$, $\Phi_{(11,2,2)(11,2,3)}$, $\Phi_{(11,2,2)(11,3,2)}$, $\Phi_{(12,2,2)(12,2,3)}$ and $\Phi_{(12,2,2)(12,3,2)}$ are π or $-\pi$ (see Fig. 6). In each x -axis, the phase-inversion wave comes from the 0th y - z plane to 10th y - z plane.	
1	The phase difference $\Phi_{(10,2,2)(11,2,2)}$ starts to change from 0 to π by the phase-inversion wave.	
2	The instantaneous frequency $f_{(11,2,2)}$ starts to change from f_{i3a3} to f_{i2a4} , because $\Phi_{(10,2,2)(11,2,2)}$ starts to change from 0 to π , two phase states ($\Phi_{(11,1,2)(11,2,2)}$ and $\Phi_{(11,2,1)(11,2,2)}$) are the in-phase synchronization, and other three phase states ($\Phi_{(11,2,2)(12,2,2)}$, $\Phi_{(11,2,2)(11,2,3)}$ and $\Phi_{(11,2,2)(11,3,2)}$) are the anti-phase synchronization.	
3	$\Phi_{(11,2,2)(12,2,2)}$ starts to change $-\pi$ to -2π by changing $f_{(11,2,2)}$.	
4	$f_{(12,2,2)}$ starts to change from f_{i3a3} to f_{i4a2} , because $\Phi_{(11,2,2)(12,2,2)}$ starts to change from $-\pi$ to -2π , three phase states ($\Phi_{(12,1,2)(12,2,2)}$, $\Phi_{(12,2,1)(12,2,2)}$ and $\Phi_{(12,2,2)(13,2,2)}$) are the anti-phase synchronization, and other two phase states ($\Phi_{(12,2,2)(12,2,3)}$ and $\Phi_{(12,2,2)(12,3,2)}$) are the anti-phase synchronization.	
5	$f_{(11,2,2)}$ doesn't arrive at f_{i2a4} and starts to change to f_{i3a3} again, because $\Phi_{(10,2,2)(11,2,2)}$ is changing to π , $\Phi_{(11,2,2)(12,2,2)}$ starts to change from $-\pi$ to -2π . In other words, three phase states of six phase states around OSC(11,2,2) are becoming the in-phase synchronization and other three phase states are becoming the anti-phase synchronization.	
6	$\Phi_{(12,2,2)(13,2,2)}$ starts to change from 0 to π by changing $f_{(12,2,2)}$.	
7	$\Phi_{(10,2,2)(11,2,2)}$ arrives at π and becomes to fix.	

In this form, the phase-inversion wave propagates on 3D lattice. Phase states of directions of which the phase-inversion wave does not propagate don't change (e.x. $\Phi_{(12,2,2)(12,3,2)}$ and $\Phi_{(11,2,2)(11,3,2)}$) when the phase-inversion waves propagate on 3D lattice.