

Modeling in Education of Antennas

#Milos Mazanek ¹, Pavel Hazdra ¹, Petr Piksa ¹, Stanislav Zvánovec ¹, Rastislav Galuscak ¹

¹Department of Electromagnetic Field, Czech Technical University, Technicka 2, 166 27 Prague, Czech Republic
mazanekm@fel.cvut.cz, hazdrap@fel.cvut.cz

Abstract

The paper is focused on the key role of modeling in education process in the field of antennas. Attention is turned not only to the modeling, but to the whole structure of education. Depending on the level of study, the balanced structure of the education is based on the appropriate amount of the theory, followed by the computer simulations, the theoretical and engineering design and development, the measurement and final evaluation, which acts as the feedback between the initial goals and the final results.

1. INTRODUCTION

Well understood theory of electromagnetic field opens the gates to the other branches of electrical engineering study. What the quality of education at technical research universities should be? What deepness to the mathematical description and physical reality to understand? What and how many branches to teach, what level of information to give and what level and quality of outputs we want to achieve? These are the main questions especially for research universities, where the deep theoretical background is the basement.

Now, using well explained/described modeling, is a chance to open the new horizons of understanding to “Maxwell equations” and what is “behind them” using the software visualization, new tools of CAD, numerical methods and optimization processes. Here is the chance to open mind of students in any level of their studies. For the future researchers, the good physical level of understanding to electromagnetic processes based on up-to-date simulation tools is necessary to follow by the stage of design and measurement. The concept of education and process how build on this knowledge is described here on the example of teaching experiences in antennas at the Department of Electromagnetic Field [1] of the Czech Technical University in Prague. Here is a key chance and important role of collaboration with industry and research units to link the education with other partner universities to keep the high standard and to be attractive for students to prepare them in flexible engineering way of understanding and thinking for their future professional carrier.

2. STRUCTURE OF TEACHING

Some of the temporary problems of technical university education in “applied electromagnetics” are:

- less contact hours with student for theory of electromagnetic field
- complicated theory for students - difficult to imagine what is “behind all the equations”
- how to teach in different levels, how to start in the very beginning where students are mostly without the deeper mathematical and physical knowledge
- do all the students need the deep background of electromagnetic field theory
- what kind of information do students need and what method of teaching to use
- how to compromise between theory and applications etc.

It is impossible to say that there is a simple final solution that gives the global answer. We can discuss how to use the state-of-art of modeling of electromagnetic field to simplify the understanding of the nature. Based on the good physical level of understanding of electromagnetic processes on up-to-date tools, we can explain complicated behavior of electromagnetic structures. In this way, we can give students good basement which is easier to remember comparing with a way of “only equations and formulas”.

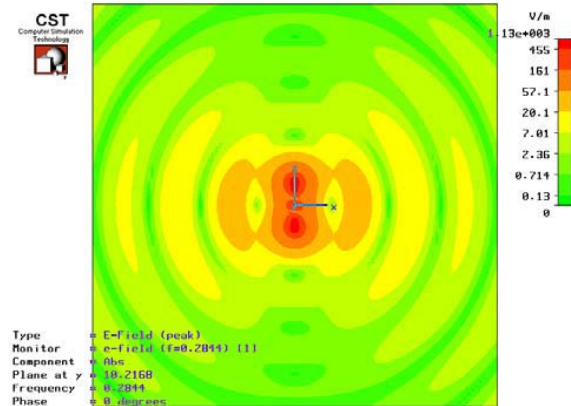

Fig. 1. “Animation” of radiation of the $\lambda/2$ dipole

It is always necessary to keep the balance, not only create interesting computer animations, but to explain them too, describe very carefully in details what everything can be seen from them. Structured and balanced process consists of:

- A. theory, basic equations, philosophy of the mathematical description
- B. modeling, simulations using different software tools (professional and/or written by students)

- C. engineering design and development
- D. measurement and evaluation

Each of these steps has a local feedback loop between the local results and previous goals as well as the final evaluation which really waited the optimum in the whole complexity including not only electrical parameters but also the material science, economy, fabrication and final cost.

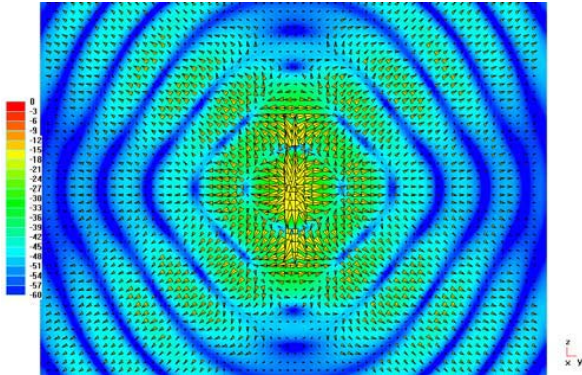

Fig. 2. "Animation" of radiation of $3\lambda/2$ dipole and power flow density

Generally, from the position of a concept of an antenna, "background" includes several well structured items.

- understanding to antennas in their complexity – transmission line, transition between the line to the radiating structure, and radiating structure itself (transformation between guided and radiated wave)
- guided and radiated waves, general concept of radiation, superposition, reciprocity, duality etc., and antenna parameters
- concept of individual sources
 - radiation of wire structures
 - radiation of apertures
- concept of arrays

Explanation of antenna theory is supported by calculations of distribution of radiating elements (e.g. elements of current). It is important that students at first are able to calculate the current distribution using their own written programs based on any software tool background and then to compare their results with the analytical ones (if possible to use them) as well as with the result of the professional simulation software. Then students are able to believe much more in their own abilities, and later they use professional software tools more carefully. Then, they do not overestimate the possibilities of software tools and they are able to find the best criteria for optimization techniques. It is necessary to create a very good description of the simulation of model including many details. Experienced comments are necessary. Fig 1 and 2 shows the near and radiative zones concept, influence of the distribution of the sources in the complex vector meaning (amplitude, phase, polarization), change between the wavelengths in the geometry limited structure (lines) and open space, phase and group velocity etc. Compare to the Figs 1-3, where lines and

planar structures were used, the radiation of an apertures are in the Fig 4 and 5. The concept of geometrical and physical optics and the real currents lines is possible to watch from them too [2]. The concept of distributed and continuous sources can support the understanding of the meaning of "array" here as well.

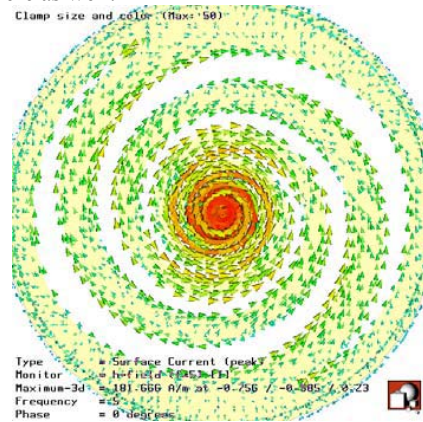

Fig. 3. "Animation" of the current distribution of a spiral structure

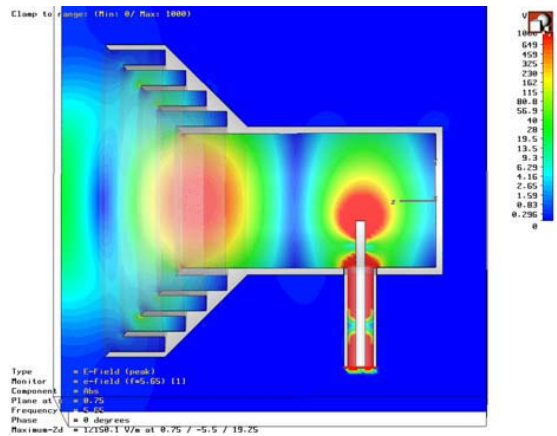

Fig. 4. "Animation" of the radiation of the aperture (corrugated horn antenna) based on the current distribution, (full wave analysis)

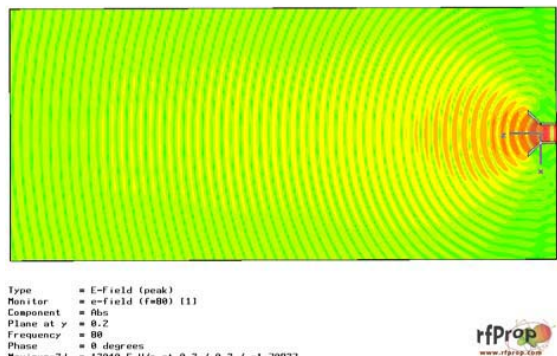

Fig. 5. "Animation" of the radiation from the aperture (horn antenna) based on the geometric optics

Polarization effects and understanding of the antenna as the generalized filter in frequency (time) and spatial domain are explained on the background of the patch antenna – Figs 6, 7, 8 and 9.

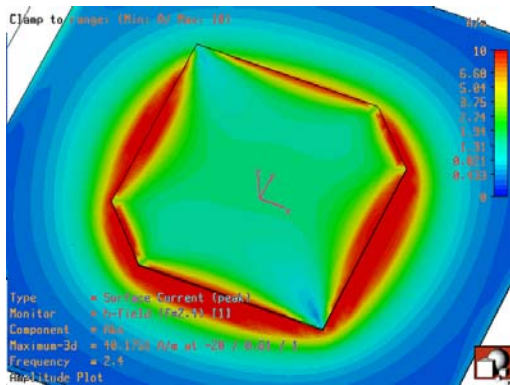

Fig. 6. Current distribution over the structure of the patch antenna

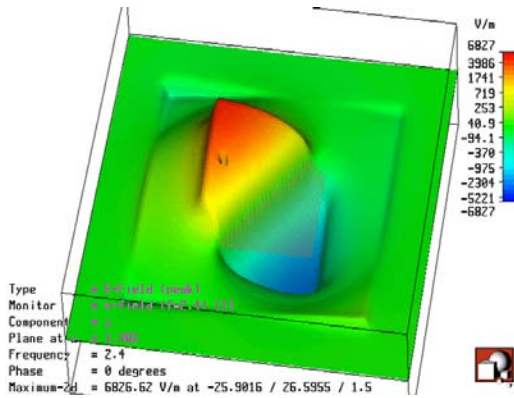

Fig. 7. "Animation" of the E field distribution on the patch antenna

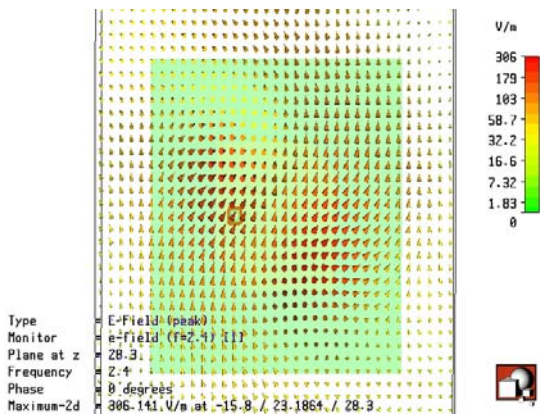

Fig. 8. E field for the polarization study of the patch antenna

“Arrays” and many other things are explained on the example of the Yagi-Uda antenna. Figs. 10, 11, 12, and 13 show the radiation, current distribution, radiation pattern and the set-up designed for measurement. Functions of elements above the resonance (inductive = reflectors) and below the resonance (capacitive = directors) are explained. The analysis of the current distribution shows the dynamic function and mutual coupling between elements (active as well as passive). Directive behavior of such structure is shown. Different phase velocity with the distance from the radiating element can be seen from the animations.

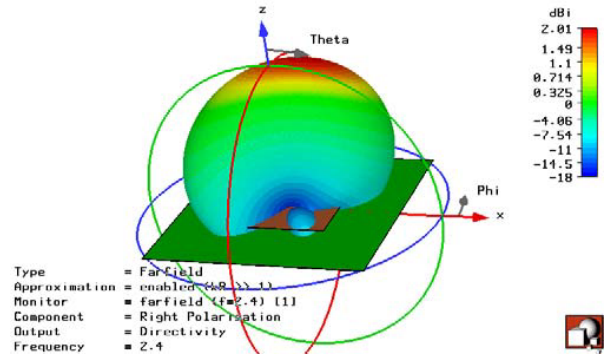

Fig. 9. Radiation pattern of the patch antenna

The “good old standard” of the theory can be used e.g. [3] together with more “modern” written books [4]. Attention is devoted to those things, which are for students usually hidden in textbooks e.g.:

- behavior of any object from a point of view of electromagnetism is only the question of distribution of electromagnetic sources (currents, charges) given by:
 - object geometry (shape, volume)
 - material parameters of the objects and media (permittivity, permeability)
- radiation pattern is a complex question of amplitude, phase, and polarization properties
- there is always relationship between an impedance and radiation characteristic of the antenna

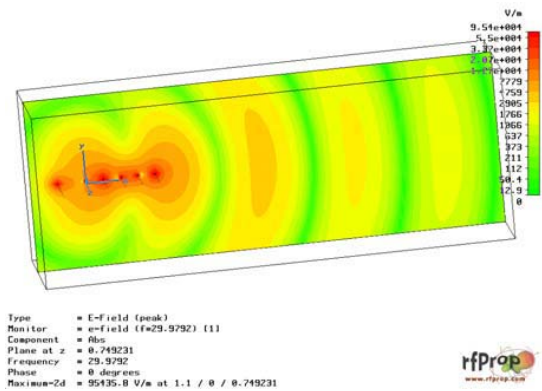

Fig. 10. Radiation of the Yagi-Uda (array) antenna



Fig. 11. Radiation of the Yagi-Uda (array) antenna – current distribution

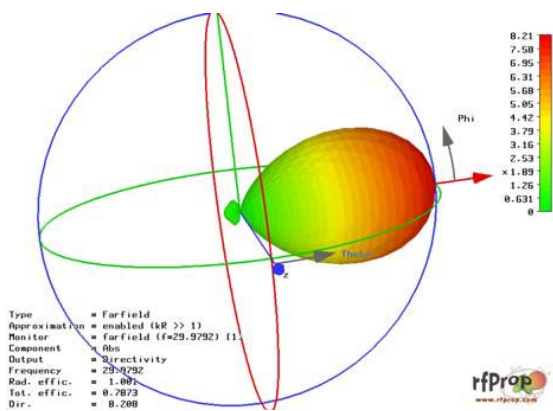

Fig. 12. Radiation pattern of the Yagi-Uda antenna

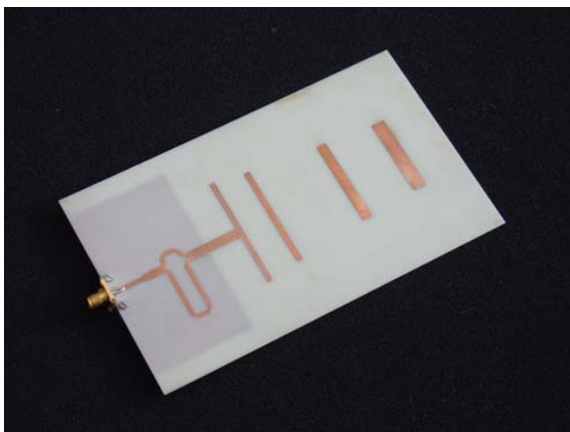

Fig. 13. Yagi-Uda antenna, planar structure setup for student measurement

The other experimental setup for practice of the students is in Fig. 14 (array of different radiators, dipoles with possibility of

capacitive loadings, patches, supply units of different phase shifters, board for spatial distribution of sources etc.).

Students prepare step by step a parametric calculation of current distribution e.g. for linear wire antenna using method of moments to study the results of wire of different length, thickness, shape etc.). They can see, that they are able to obtain good results with quite simple process. Then students can use professional software tools for modeling of more complicated structures. They see that the complexity is only the problem of shape and feeding position. This process is very efficient and students have a chance to understand more about the numerical results compared with the case where directly the “ready made” software tools and calculations are used.

The problem of an antenna design is generally much more coupled with other engineering branches – students need to choose the materials not only from a point of view of its electrical parameters, but they have to choose it from a point of view of mechanical and environmental properties as well. The other thing is to compare different designs from a point of view of economy (reproducibility, needs of individual tuning etc.) and, of course, from a point of view of its final cost. Chosen quality of fabrication depends on the complexity of construction and final needs.

To keep the balance between theoretical and design parts of the education, the measurement with samples designed and directly fabricated or ready made modular antenna prototypes is used. Such an approach has been chosen to support the education process. Most of the measurement is performed in the antenna anechoic chamber of DEF CTU in Prague which enables the limited far field as well as compact range (CATR) and near field (planar scanner) methods of measurement. Students have a chance to measure radiation pattern and the other parameters of the same antenna using different methods and then to compare them.

System of experimental set up antennas has been designed and realized to enable fast and simple modification between individual spatial and electrical configurations of prototypes during a time limited measurement. Modular structure of basic types of antennas to create the experimental set-up to demonstrate influences of individual parameters of the structure was used. Resulting changes in impedance and radiation properties of antennas are measured and evaluated by students in relation with theory (analytical approach) and simulation (numerical approach) of radiating sources distribution.

Patch array (Fig. 14) for 1.8 GHz band has been designed to demonstrate basic properties of antenna array factor. Array enables to change element separation (from 0.6 to $1.0 \lambda_0$ with $0.1 \lambda_0$ step), and feeding current distribution in amplitude (uniform 1-1-1-1 and nearly optimal 1-1.7-1.7-1) and phase. (Fig. 14) The array consists of four patches, two types of power dividers, set of coaxial cables of different length (for

different phase shift) and mechanical mounting for element and power divider handling. Electronically controlled phased array is designed as multifunctional prototype that is able to demonstrate the influence of current amplitude and phase distribution (changes), element separation (achieved by frequency change of equidistantly placed elements) and element type on the array properties. The prototypes consist of synthesized generator, board with feed network and quadrature modulators (AD8346 working in 0.8 - 2.5 GHz) for amplitude and phase shifting and different removable radiators (monopole, spiral and patch).



Fig. 14. Modular antenna array setup

3. EDUCATION AND RESEARCH

For higher level of education, some fringe results of research are directly used. The goal of the example (design of the dual polarized illuminator) is to improve the overall efficiency of a parabolic antenna for the centre frequency 1.3 GHz. We need:

1. high gain
2. low noise
3. RHC and LHC polarization with good axial ratio
4. handle power up to 1.5 kW
5. easy mechanical construction and low cost

Because the structure (Fig. 15) is quite complex to perform a full-wave optimization directly, it is divided into two somewhat independent steps:

1. Design of the 5-step septum in a circular waveguide using the Mician Microwave Wizard (MMW) [5]. This software utilizes fast modal matching techniques.
2. Design and adjustment of the coaxial-semicircular waveguide transition together with the septum by using the full-wave FIT method implemented in CST Microwave Studio (CST MWS) [6].

Simulations in MMW (see Fig.16) were intended to achieve the maximum possible separation between the radiated LHC and RHC components by adjusting all parameters of the 5-step septum. The best separation obtained was about 50 dB. Once the optimum dimensions of the 5-step septum were determined, the entire feed was simulated using CST MWS

applied to the model. Electrical excitation of the waveguide was chosen because of its simplicity. Two probes with conical shapes (see Figs. 17 and 18) were employed to match the waveguide structure to the input coaxial line. Because of the structure's symmetry ($S_{11}=S_{22}$, $S_{12}=S_{21}$), simulation of only one port was necessary. The optimization strategy used was to determine the probe parameters leading to the best matching and isolation between ports. Final results exhibits excellent rotational symmetry – Fig. 19 and the axial ratio does not exceed -1 dB within the range of $-50^\circ < \theta < +50^\circ$ (Fig. 20).

The feed has been fabricated using duralumin and measured. Excellent agreement between CST MWS simulations and actual measurements has been observed (see Fig. 21). The input coaxial connector has been slightly simplified for the simulated model; this may explain the slight deviations in measured S_{11} from the simulated values. However, for 1.3 GHz the measured matching is $S_{11} = -35$ dB (VSWR = 1.00063) and isolation $S_{21} = -26.5$ dB. Frequency bandwidth for $S_{11} < -30$ dB is 11%.

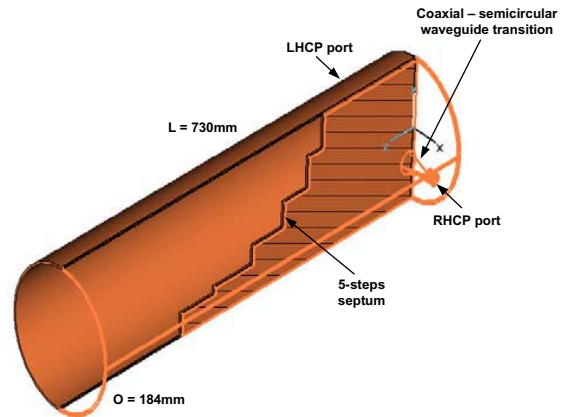

Fig. 15. Proposed septum feed layout

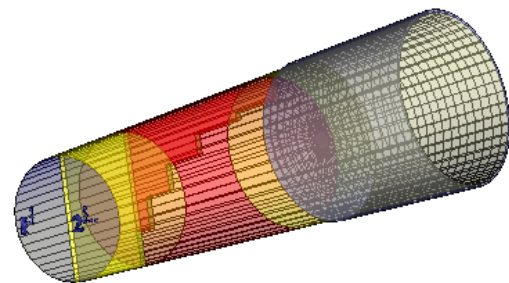
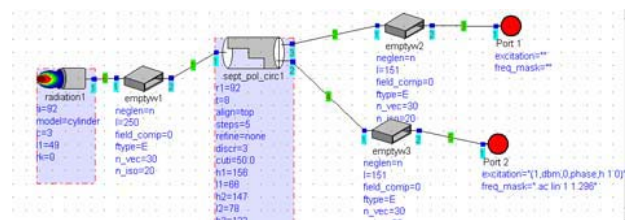

Fig. 16. Simplified feed model for MMW analyses

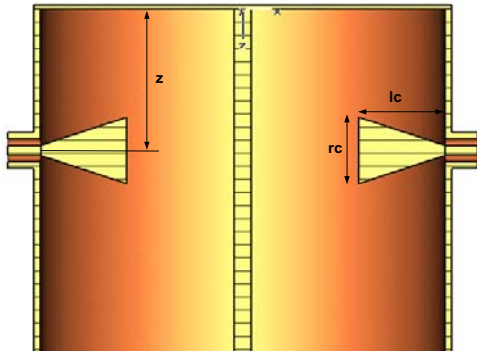

Fig. 17. Detailed sectional view of the cone transition

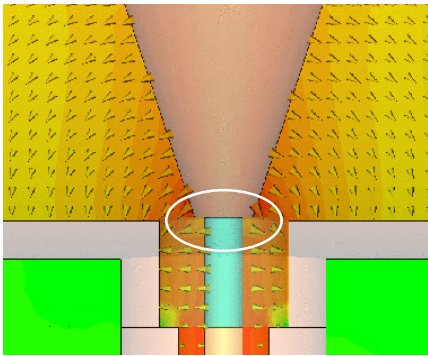

Fig. 18. Intensity of electric field

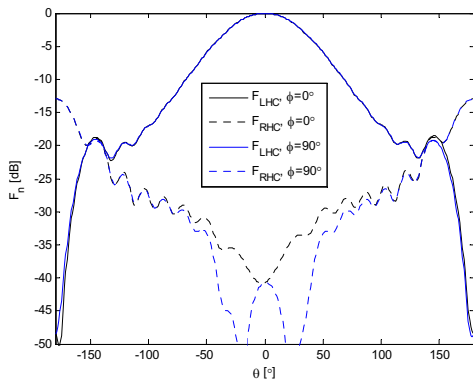

Fig. 19. Normalized LHC and RHC patterns at 1296 MHz for two perpendicular cuts, $\Phi=0^\circ$ and $\Phi=90^\circ$

4. CONCLUSION

Up-to-date attitude to the teaching of antennas, which is used at the Department of Electromagnetic Field, Czech Technical University in Prague was introduced. The general structure of a theoretically and experimentally balanced education (theory, modeling, design, measurement, evaluation) was mentioned. The courses and especially the animations are attractive for students. On the other hand such attitude is always a question of teaching economy due to the time

consuming measurement compare to the mass courses based only on software tools and modeling.

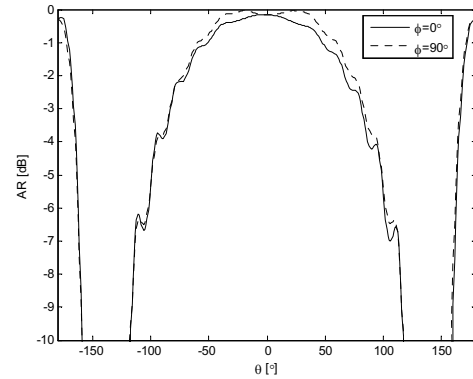

Fig. 20. Axial ratio at 1296 MHz for two perpendicular cuts, $\Phi=0^\circ$ and $\Phi=90^\circ$

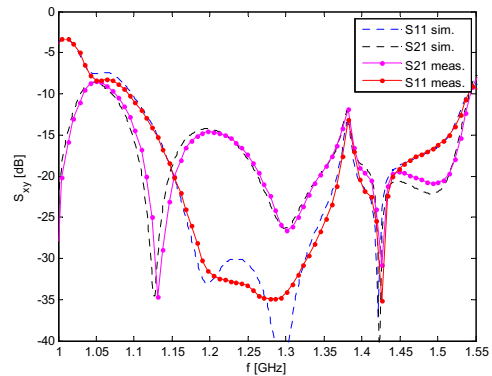

Fig. 21. Simulated and measured S-parameters

ACKNOWLEDGEMENT

This work has been conducted at the DEF of the CTU in Prague and supported by the Czech Ministry of Education, Youth and Sports in the frame of the project FRVS "New methods of teaching antennas and electromagnetics". These activities were included also into European School of Antennas (ESoA) in a frame of Antenna Centre of Excellence (ACE2) [7].

REFERENCES

- [1] www.elmag.org, www.rfspin.com, Department of electrical engineering, CTU Prague, 2006
- [2] Valtr, P., Pechac, P., "Diffraction Calculations and Measurements in Millimeter Frequency Band" *Radioengineering*. vol.13, no.3, p.18-21. September 2004
- [3] Kraus, J., *Antennas*, McGraw-Hill, Inc. Boston 1988
- [4] Balanis, C.A., *Antenna Theory*, John Wiley & Sons, Inc. New York, 1997
- [5] www.mician.com Mician GmbH, 2006
- [6] www.cst.de Computer Simulation Technology, 2006
- [7] www.antennasvce.org, Antenna Centre of Excellence (ACE2), 2006