

DEVELOPMENT OF THE NEW CHARACTERISTIC IMPEDANCE MEASUREMENT METHOD USING THE SINUSOIDAL WAVE TDR

Takehiro Takahashi, Takashi Sakusabe and Noboru Shibuya

Department of Computer Science, Faculty of Engineering, Takushoku University

E-mail: take@cs.takushoku-u.ac.jp

Abstract: The new measurement method of the characteristic impedance is developed. The measurement principle is based on the TDR method using the sinusoidal wave. The new method is experimentally demonstrated for the transmission line cable and the printed circuit board. For the exact derivation of the characteristic impedance, the signal processing such as the wave separation and the impedance extraction methods is applied successfully.

Key words: Characteristic Impedance, Sinusoidal TDR method, Printed Circuit Board

1. Introduction

In recent years the transmission characteristics of the printed circuit board (PCB), especially the characteristic impedance in the high frequency region should be controlled according that the electronic devices operate at high speed and frequency. Therefore, it is considered that the characteristic impedance of the PCB is well "controlled", but in many cases only in time domain.

In general the characteristic impedance of the lossless trace depends only on the geometry of the transmission line. However for the lossy trace like PCB at high frequency region the frequency dependence of characteristic impedance should be taken into account and thus measured with easy method.

The measurement method of the characteristic impedance is divided roughly into two methods; the frequency domain open-short method, and Time Domain Reflectometry (TDR) method. There are merits and demerits in each of these methods.

The frequency dependence of the characteristic impedance can be measured by the open-short method. The measured value, however, lacks correctness in the high frequency region because the difference of the trace length between open and short conditions can't be ignored. Furthermore, the spatial change of characteristic impedance can't be measured by the open-short method.

On the other hand, the TDR method is simple and easy and is often used for the characteristic impedance measurement of the PCB. But the demerit is that the frequency dependence can't be measured.

So, the new measurement method of the frequency

dependence of the characteristic impedance was devised by using the TDR method.

This method uses the sinusoidal wave modulated by rectangular wave shape instead of the simple rectangular wave of the TDR method. (Hereafter, this method is called as the sinusoidal wave TDR method, or SW-TDR)

The principle of the sinusoidal wave TDR method and experimental details using the prototype measurement set-up are described here. The characteristic impedance measurement results and the future subjects are also discussed in this report.

2. The principle of the sinusoidal wave TDR method

In the following the measurement principle of the sinusoidal wave TDR method is explained.

The signal source which has the output impedance Z_s is connected to the source end of the transmission line of the length l , the characteristic impedance Z_0 , and the phase constant β . The receiving end is terminated by the load impedance Z_r . The sinusoidal burst signal V_{in} is input as the signal source. The voltage reflection coefficients are given as Γ_s and Γ_r at the driving and receiving ends respectively.

Considering $\theta(t)$ as a unit step function, the voltage wave shape at the driving end of the transmission line is given as equations (1).

$$V(0) = V_{in} \frac{Z_0}{Z_0 + Z_s} [\sin(\omega t)\theta(t) + \Gamma_r(1 + \Gamma_s)\sin(\omega t - 2\beta l)\theta(t - \frac{2\beta l}{\omega}) + \Gamma_r^2\Gamma_s(1 + \Gamma_s)\sin(\omega t - 4\beta l)\theta(t - \frac{4\beta l}{\omega}) + \dots] \quad (1)$$

$$Z_0 = Z_s \frac{V(0)}{V_0 - V(0)} \quad (2)$$

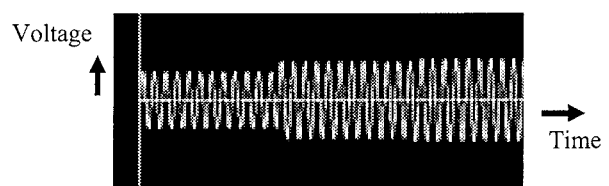

Fig.1 Superimposed lumped sinusoidal wave

3C4-5

Therefore, the reflected wave piles up with the incident wave after the forwarding and returning interval of the trace, and the voltage wave form shows the complex shape like Fig.1 which shows the calculated example of the sinusoidal TDR wave shape at the input end in the case of frequency 200MHz, $l=5m$, $Z_o=70\Omega$, $Z_s=50\Omega$ and $Z_r=\infty$ (open).

The characteristic impedance is obtained from the voltage value V_{in} of the signal source (open circuit voltage) and the voltage value $V(0)$ at the input end of the transmission line in accordance with the eq.(2).

In this case it may be possible that the characteristic impedance at each frequency can be measured by TDR method with making the frequency of the sinusoidal wave of the signal source change.

3. Measurements

3.1 Measurement circuits and method

The circuit system to measure the characteristic impedance by this sinusoidal wave TDR method consists of the sinusoidal wave generator, the step wave shape generator and the switching multiplexer(IC) as shown in Fig 2.

A sinusoidal wave is modulated by the step-shaped wave by switching multiplexer and the burst sinusoidal wave is output and applied to the sample.

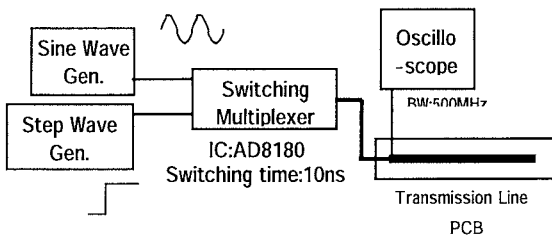

Fig.2 Block diagram of the Circuit

3.2 Measurement results

(1) The measurement on semi-rigid cable

First, to confirm whether this method is valid or not, the long semi-rigid cable (5m in length, $Z_o:50\Omega$) was used because the time interval from incidence to reflection of the wave is more than 10ns which is the switching time of the switching multiplexer used. Then the wave shape can be measured by the oscilloscope.

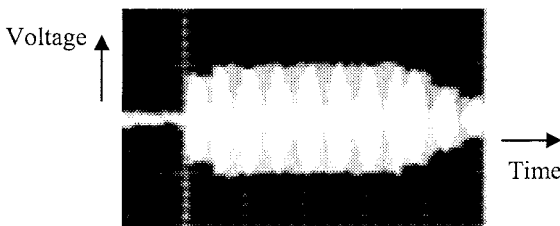

Fig.3 Measured waveform from the long trace

An example of the measurement results is shown in Fig.3. From the measured V_{in} and $V(0)$, the characteristic impedance was calculated by using eq.(2) and is shown in Fig. 4.

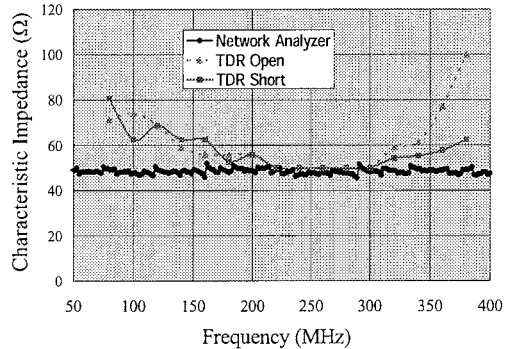

Fig.4 Frequency dependence of the characteristic impedance Z_o (5m trace)

The value of the characteristic impedance was measured as almost 50Ω in the frequency range of 200-300MHz. It was measured about 10% -30% high in the frequency range less than 200MHz and more than 300MHz. As a result the characteristic impedance of 5m long semi-rigid cable can be measured by this measurement method.

Next, the characteristic impedance of the same sample was measured by using network analyzer to ascertain how much the measurement result of sinusoidal TDR method agreed to this measurement result. The result is also shown in Fig. 4.

(2) Microstrip trace.

As the next step, the impedance of the microstrip trace on the printed circuit board (28cm in length and $Z_o:70\Omega$) was measured. An example of the measurement wave shape and the frequency dependence of characteristic impedance are shown in Fig. 5 and Fig.6. The characteristic impedance changes very much around 70Ω in the measured frequency range as shown in Fig.6.

One of the possible reason for inaccurate results is following. Because of the short trace enough cycle of sinusoidal wave necessary for measurement can't be obtained and thus piled up wave shape can't be separated precisely by the visual observation.

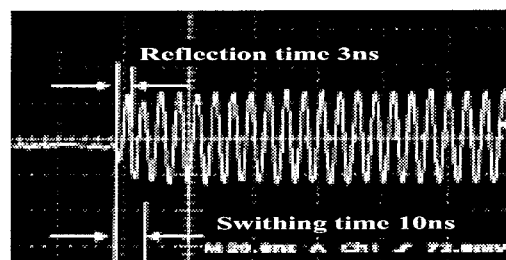

Fig.5 Measured waveform from the short trace

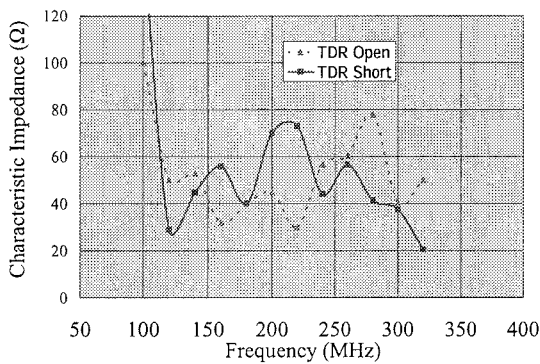

Fig.6 Frequency dependence of characteristic impedance (0.28 m trace)

3.3 Consideration of the experimental results

(1) Long trace case .

The reason why the impedance of 5m long semi-rigid cable couldn't be measured precisely at the frequency below 200MHz and beyond 300MHz can be considered as follows.

① The frequency range of oscilloscope used was 500MHz, and the wave shape couldn't be measured properly at the high frequency region because of the limitation of the frequency band width.

② The lower frequency limit for the precise measurement may depend on the trace length l.

For example, the wavelength of 100MHz electromagnetic wave is 3m in vacuum, and this is the same order of the trace length used this time.

The relationship between the frequency f at which transmission line theory is applicable, and the trace length l is

$$f \approx \frac{nv}{l}, \quad (3)$$

where v is the velocity of the electromagnetic wave in the medium and n is an integer. Here, if n=5, l=5m, v=2x10⁸m/c, then f is nearly 200MHz. Then more accurate measurement can be made over that frequency.

(2) Short trace case.

For example, after the signal input into the 30cm trace, the signal traveling time until return is 3ns (in case of the transmission speed as 2x10⁸m/s.) as shown in Fig.6.

On the other hand, the rising time of used switching element is 10ns, and the reflection comes back in switching transient period in this experiment. Therefore, when the trace to measure is too short, the accurate measurement can't be done by the visual observation.

4. Signal Processing for Impedance Extraction

So, from the reason mentioned above the reflection wave shape thus the reflection coefficient are tried to separate from the composite wave shape by software tools, and the examination was made to obtain the characteristic impedance. The flow of this method is shown in Fig. 7.

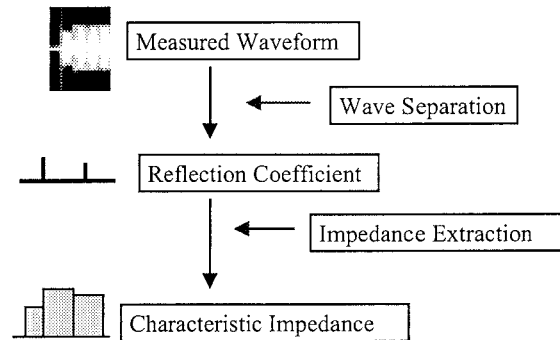

Fig.7 The Flow of Signal Processing

4.1 Wave shape separation

The measured wave shape is transformed to the frequency domain by the Fourier transform and processed by Wiener filter to obtain the reflection coefficient as shown in Fig.8.

The Wiener filter is given by eq.(4)

$$H(f) = \frac{F(f)}{(G(f) + N)} \quad (4)$$

H(f) : Fourier transform of the reflection coefficient t

F(f) : Fourier transform of the measured wave

G(f) : Fourier transform of the reference wave

N : White Noise

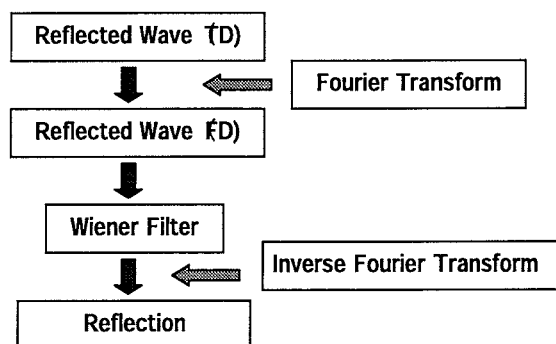

Fig.8 Process Flow of Wave Separation

4.2 Impedance extraction.

An unknown transmission line is divided into segments of the N individuals, and the impedance can be obtained by giving it the reflection coefficient in each segment^[1]. Fig. 9 shows the state in which a lumped voltage wave spreads toward the front and returns back repeating the reflection. In this case, the

3C4-5

relationship between the reflection coefficient and the characteristic impedance is given in eq. (5)

$$Z_i = Z_{i-1} \frac{1-\rho}{1+\rho} \quad (5)$$

- Z_i : Characteristic Impedance of the ith segment
- Z_0 : Characteristic Impedance
- ρ : Reflection Coefficient between the segment layers

After the iterative processing using eq.(5), the characteristic impedance distribution can be obtained.

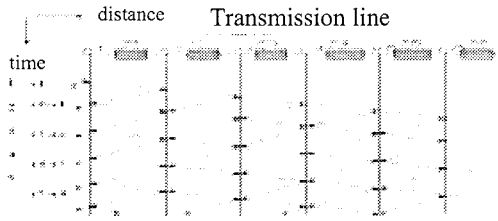

Fig.9 Wave Propagation through the transmission line

5. Processed result and consideration

5.1 Wave shape separation processing

A processed result for the sample wave shape is shown in Fig. 10. In Fig.10 the composite wave shape is made from the certain wave shape and two times wave of it which is moved by 64 dots. In the middle of Fig.10 the Wiener filter was operated on the composite wave shape. A bottom figure shows the reflection coefficient of the composite wave shape by inversely transforming a middle wave form into real space.

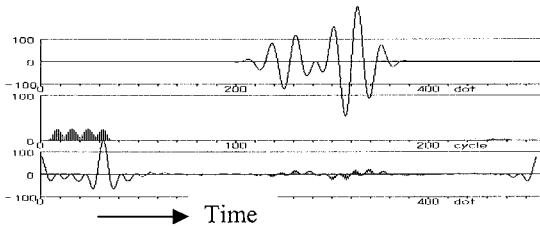

Fig.10 Wave separation (Sample waveform)

From the processed results, the space of two peaks of the reflection coefficient corresponds to 64 dots distances. And it is also confirmed that strength of second peak is about two times of first peak. The validity of this method was confirmed from the result.

5.2 Impedance Extraction Processing

An example of the extraction of the characteristic impedance from the reflection coefficient using eq.(5) is shown in Fig.11. This extraction method was applied to the measured data and the

characteristic impedance (50Ω) of 1.9 m cable was obtained as in Fig.12.

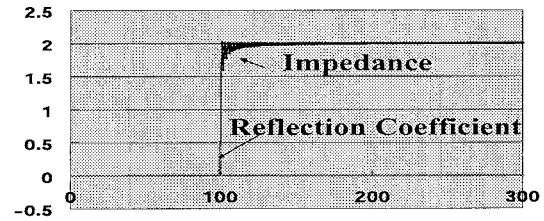

Fig.11 Impedance extraction (sample waveform)

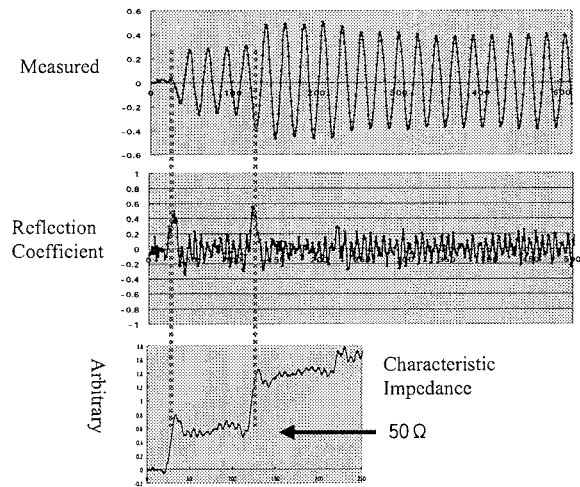

Fig.12 Impedance extraction from measured data

6. Conclusion

It is confirmed that the frequency and position dependence of the characteristic impedance can be measured by the newly developed SW-TDR method. And, it was also found that the impedance can be measured by using software processing technique from the principle viewpoint. But, the actual measurement value could change with the small noise component superimposed to the signals.

As the tasks in future,

- (1) The development of the technique for the separation of the piled-up reflection wave and the extraction of the characteristic impedance for the short trace should be looked for.
- (2) Although the measurement only up to 500MHz can be done at present, the measurement in the high frequency region becomes possible in future by using wide band oscilloscope and high-speed switching IC.

References

[1]N.D.Megil: "Method for Impedance distribution measurement of the transmission line using TDR and Computer", Nikkei electronics, 1981,10.26