

SPHERICAL ARRAY ANTENNA USING DIGITAL BEAM FORMING TECHNIQUES FOR MOBILE SATELLITE COMMUNICATIONS

Wataru CHUJO, Kanshiro KASHIKI, Hisao IWASAKI and Koji YASUKAWA
ATR Optical and Radio Communications Research Laboratories
Sanpeidani, Inuidani, Seika-cho, Soraku-gun, Kyoto 619-02, Japan

1. Introduction

A spherical array antenna, which has a particular advantage in terms of wide angle scan region, may be applied to mobile terminal in maritime, aeronautical and land mobile satellite communications. In mobile satellite communications, since the required number of elements is not large, it will be important to determine proper phase and amplitude distribution to each antenna element to achieve maximum gain rather than low sidelobes.

This paper is concerned with beam forming techniques utilizing the signal-amplitude and -phase information of each element, assuming the usage of digital beam forming (DBF) techniques in which the received signals are detected and digitized at the element level [1]. First, characteristics of a spherical 16-element array antenna with circular polarization, are examined by computer simulation, and it is clarified that the method, in which selection of elements to be excited and adjustment of their phase and amplitude are made using the received signals, is effective to the beam scanning under the condition of maximum gain. Second, it is shown that phase and amplitude detection by reference carrier recovery circuit of each antenna element, is effective to the spherical array antenna, when constant envelope signals such as BPSK, usually used in the satellite communication link, are received by the spherical array antenna.

2. Beam Scanning Characteristics of Spherical Array Antenna

A hemispherical 16-element array which is considered hereafter is shown in Fig.1. The elements are arranged at the vertices and mid points of the sides of an icosahedron inscribed in a sphere [2]. It is assumed that the characteristics of the array, whose elements are selected and phase and amplitude adjusted using the received signals, are considered in this section. In the case of adjusting the phase of each selected element to co-phase and combining each signal with equal amplitude, the beam scanning characteristics of gain are obtained as shown in Fig.2. Although there is a slight difference in gain due to the effective relative permittivity ϵ_e of microstrip antenna, the amount of gain reduction at $\theta = 60^\circ$ is about 2 dB from boresight in all cases. In combining the signals with equal amplitude, however, discontinuities of gain arise at $\theta = 30^\circ$ and 60° . On the other hand, when each signal is combined with the amplitude proportional to the received signal level, the beam scanning characteristics of gain are given as shown in Fig.3. It is seen from the figure that the gain is increased over wide scan angles and there is less difference in gain due to ϵ_e than in Fig.2. These results are compared with the maximum gain calculated by the optimization method[3]

as shown in Fig.4. Thus the method, in which each element signal is combined in proportion to the received signal level, is suitable to maximize gain.

3. Phase Detection Error and Gain Reduction

Configuration of a DBF antenna with carrier recovery circuits in each antenna element is shown in Fig.5. In this section, the phase error detected by the carrier recovery circuit and gain reduction due to the error are presented. The following assumptions are made: digital modulation method is BPSK, incident signals at $\theta = 60^\circ$ are received by 16-element planar array, and bit error rate of combined signals are 10^{-5} without phase and amplitude error. When the received signals are demodulated using a first-order costas loop in N-element planar array, standard deviation of phase detection error of each element is shown in Fig.6, where δ shows loop signal-to-noise ratio. Note that for a 16-element array, phase errors are nearly the same as those of a 5-bit digital phase shifter.

Gain reduction of an array antenna due to phase errors [4] is expressed by

$$G/G_0 = \left[\sum_{n=1}^N \sum_{m=1}^N a_n a_m \cdot \exp(-(\sigma_n^2 + \sigma_m^2)/2) + \sum_{n=1}^N a_n^2 (1 - \exp(-\sigma_n^2)) \right] / \sum_{n=1}^N \sum_{m=1}^N a_n a_m \quad (1)$$

where a_i is multiplication of the i th element factor and the weight, and σ_i^2 is the variance of the phase error of the i th element. The gain reduction of a spherical array antenna is compared with that of a planar array as shown in Fig.7. This figure shows the case of beam scanning in a fixed plane ($\phi = 0^\circ$), and $\delta = 200$. It can be seen that in planar array, the gain decreases at angles away from broadside. On the other hand, in a spherical array, the gain reduction is almost constant independent of the scan angle.

4. Amplitude Detection Error and Gain Reduction

As BPSK signals have a constant envelope, gain contribution of each element in the incident direction of the received signals can be known by detection of the signal amplitude. In this section, the amplitude error detected by the carrier recovery circuit and gain reduction due to the errors are presented. Since amplitude contains no information, unlike phase in BPSK signals, the gain contribution can be determined by the mean value of the detected amplitude.

The mean value of the detected amplitude in an N-element planar array is shown in Fig.8. In a 16-element planar array, the mean value of the amplitude can be controlled in the area from -0.3 dB to 0.2 dB by selecting BT = 0.5 or 1.0.

The gain reduction due to the amplitude error in a 16-element hemispherical array is shown in Fig.9. The beam is assumed to be scanned in a fixed plane ($\phi = 0^\circ$), and the actual gain is compared with the error-free gain in this figure. It is difficult to distinguish between the actual gain and the error-free gain.

5. Conclusion

In this paper, it has been shown that the radiation pattern of a spherical array antenna can be scanned under the condition of maximum gain, without the influence of the element pattern, by use of the received signal-amplitude and -

phase information. Furthermore, in the case of constant envelope signals such as BPSK, the amplitude and phase error of each element has been computed, and the amount of gain reduction due to the errors has been shown quantitatively. As a result, it seems evident that the proposed method using the amplitude and phase information of each element, is suitable for mobile satellite communications. The key to the success of this method is to develop a carrier recovery circuit operating under low signal-to-noise ratio conditions.

Acknowledgment: The authors would like to thank Dr. Y.Furuhama, President of the ATR Optical and Radio Communications Research Laboratory, for his encouragement throughout this work.

References

- (1)H.Steyskal :“Digital beamforming antenna, an introduction”, Microwave Journal, pp.107-124 (Jan.1987)
- (2)D.L.Sengupta, T.M.Smith and R.W.Larson :“Radiation characteristics of a spherical array of circularly polarized elements”, IEEE Trans. Antennas & Propag., AP-16, 1, pp.2-7 (Jan.1968)
- (3)Y.T.Lo, S.W.Lee and Q.H.Lee :“Optimization of directivity and signal-to-noise ratio of arbitrary antenna array”, Proc. IEEE, 54, 8, pp.1033-1045 (Aug.1966)
- (4)B.Steinberg :“Principles of aperture and array design”, John Wiley (1976)

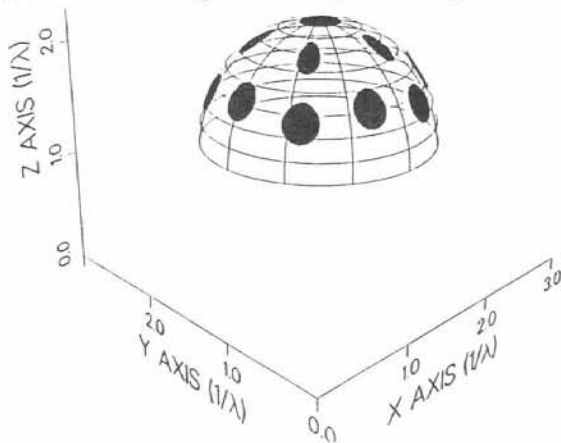

Fig.1. Configuration of a hemispherical 16-element array.

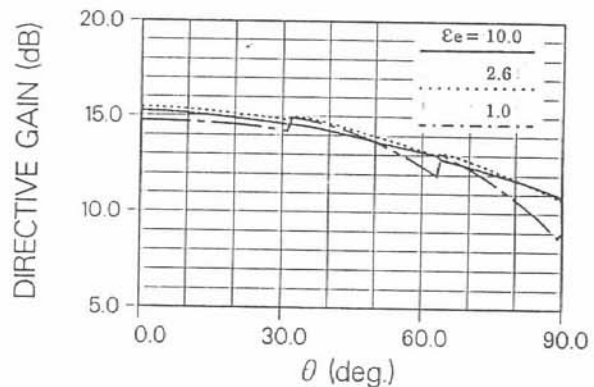

Fig.2. Beam scanning characteristics of directive gain : combining with equal amplitude.

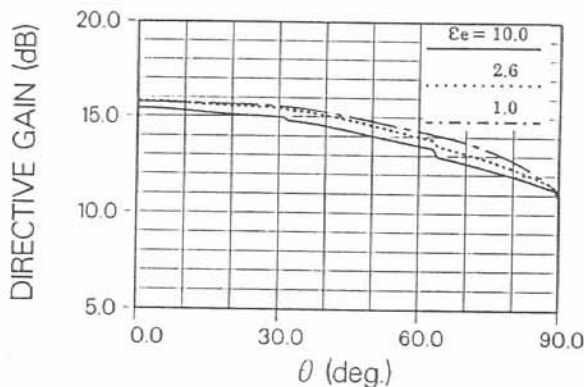

Fig.3. Beam scanning characteristics of directive gain : combining with the amplitude in proportion to the received signal level.

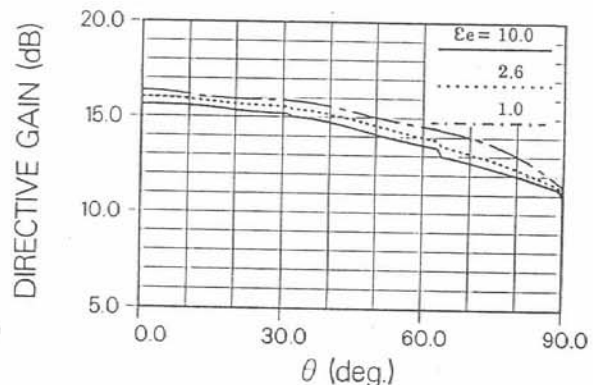

Fig.4. Beam scanning characteristics of maximum directive gain.

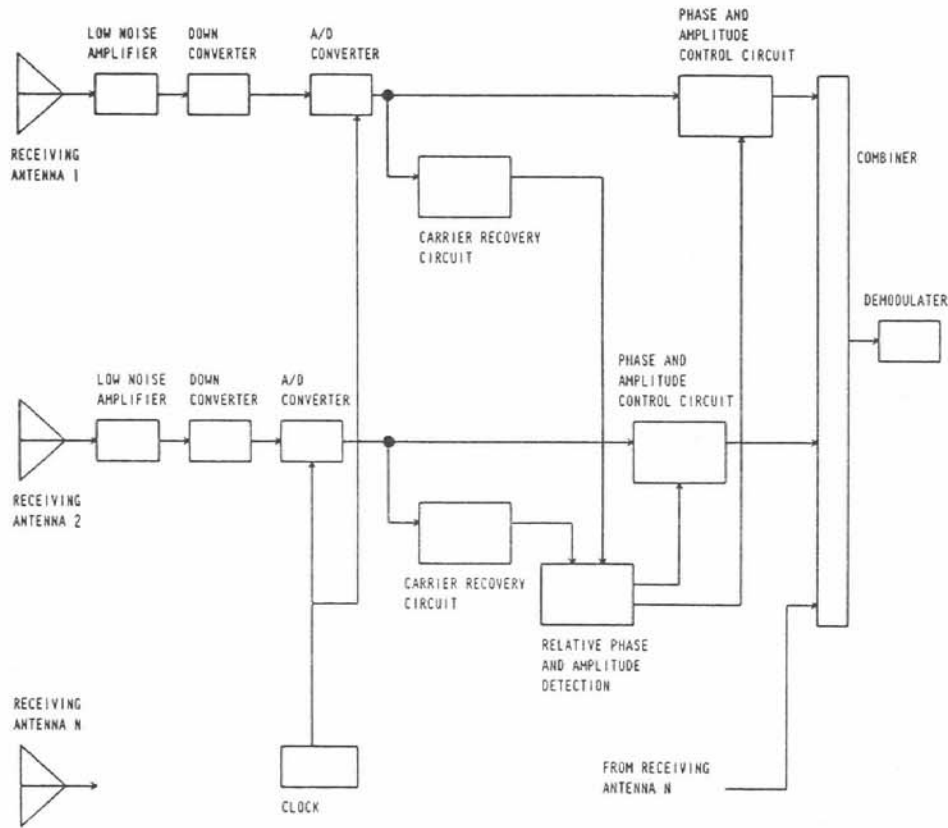

Fig.5. Configuration of a digital beamforming antenna possessing carrier recovery circuits in each antenna element.

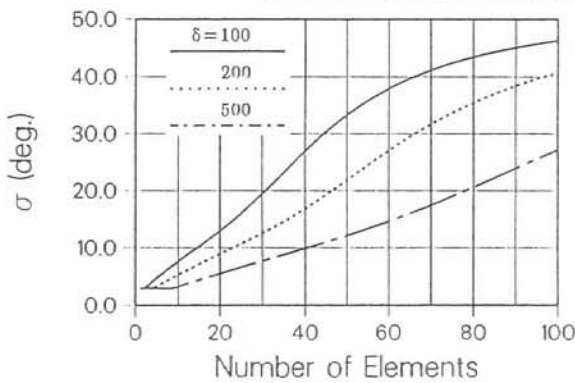

Fig.6. Standard deviation of phase detection error in N-element planar array.

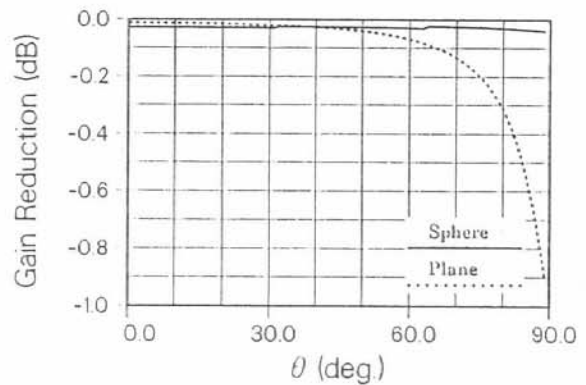

Fig.7. Gain reduction due to phase detection error in 16-element hemispherical array.

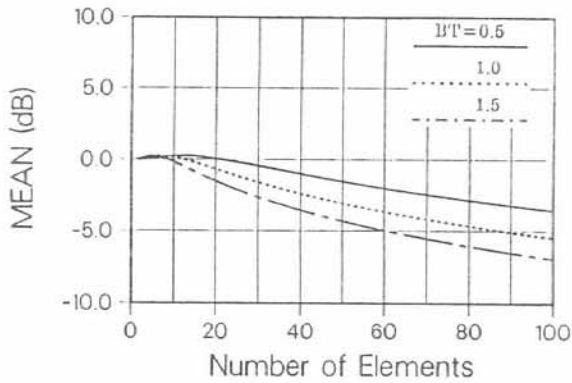

Fig.8. Mean value of detected amplitude in N-element planar array. BT gives the ratio (low pass filter bandwidth)/(bit rate).

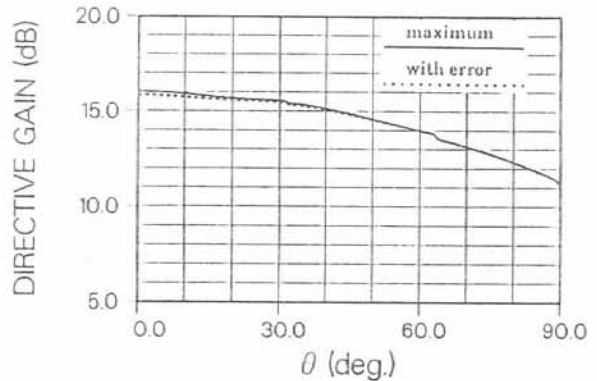

Fig.9. Gain reduction due to amplitude detection error in 16-element hemispherical array.