

**A BROADBAND WAVEGUIDE MONOPULSE COMPARATOR
WITH PHASE COMPENSATION CIRCUITS**

M.Saitoh[†], H.Uchida[†], N.Yoneda[†], K.Kakizaki[‡], Y.Konishi[†] and H.Oh-hashi[†]

[†] Information Technology R&D Center, Mitsubishi Electric Corporation

5-1-1 Ofuna, Kamakura-shi, Kanagawa, 247-8501 Japan

[‡] Kamakura works, Mitsubishi Electric Corporation

325 Kamimachiya, Kamakura-shi, Kanagawa, 247-8520 Japan

m_saito@isl.melco.co.jp

1. Introduction

A monopulse comparator is used in a radar system for determining the azimuth and elevation of a target. Generally, a monopulse comparator consists of four 180° hybrid couplers[1]. A configuration using four 90° hybrid couplers and some phase shifters instead of four 180° hybrid couplers is also known[2]. The later configurations are often applied for waveguide type monopoles comparators, because of simple structure without intersection of waveguides. However, it has a problem with a narrow-band performance due to the frequency characteristic of the phase shifter using waveguide delay lines.

In this paper, we propose a waveguide type monopulse comparator using delay lines with phase compensation circuits. The phase compensation circuit cancels the frequency characteristic of the delay line by utilizing dispersive characteristics of waveguides with different cross sections. The broadband characteristic of proposed circuit has been verified by electromagnetic simulations and experiments.

2. Configuration of monopulse comparator using 90° hybrid couplers

Figure 1 shows a schematic diagram of a monopulse comparator using 90° hybrid couplers and delay lines. In Figure 1, ports of monopulse comparator (A, B, C, and D) are connected to each antenna elements that is quarter part of whole aperture divided with the horizontal axis and vertical axis. E₁ and E₂ are waveguide delay lines which generate phase shifts of $-\pi/2$ and $-\pi$ for E₀, respectively. Although, the coupling phase of a conventional 90°

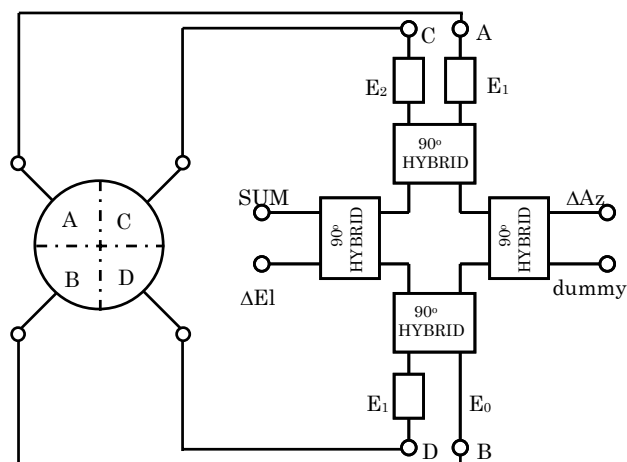

Figure 1: A schematic diagram of a monopulse comparator

hybrid coupler has very small frequency dependence, the phase shift caused by the waveguide delay line changes according to the frequency. Therefore, this configuration is unsuitable for broadband applications without phase compensation circuits.

3. Delay line with the phase compensation circuit

Figure 2 shows the proposed delay line with the phase compensation circuit. In the following discussion, the phase shift generated by the insertion phase difference between Line-1 and Line-2 is set to $\Delta\phi$. Waveguide-A with a same cross section as input/output waveguides and length of l_1 is inserted in Line-1, and Waveguide-B with a wider cross section than input/output waveguides and length of l_2 is inserted in Line-2. The propagation constant β_i of a waveguide is the function of the width of waveguide cross section a_i , and it is calculated by the following equation:

$$\beta_i(\omega) = \sqrt{\omega^2 \varepsilon \mu - (\pi/a_i)^2} \quad (1).$$

Hence, Waveguide-A and Waveguide-B have different dispersion characteristics due to different a_i . Equation (1) shows that wider waveguide has smaller frequency dependence in the propagation constant.

The principle of the proposed phase compensation circuit is illustrated in Figure 3. In this figure, (a) shows frequency characteristic of insertion phase through Line-1. If no compensation is applied, the width of the Waveguide-B is same as Waveguide-A ($a_2 = a_1 = a_0$), and the insertion phase of Line-2 has frequency dependence like (b). So, phase difference between Line-1 and Line-2 is $\Delta\phi$ only at the center frequency. On the other hand, (c) shows frequency characteristic of the insertion phase through Line-2 when the width of Waveguide-B a_2 is properly chosen. Owing to the difference of dispersion characteristic caused by the difference of waveguide width (a_1 and a_2), the group delay of two lines can be matched around the center frequency f_0 . So, the phase difference between Line-1 and Line-2 can be kept $\Delta\phi$ in wide-band.

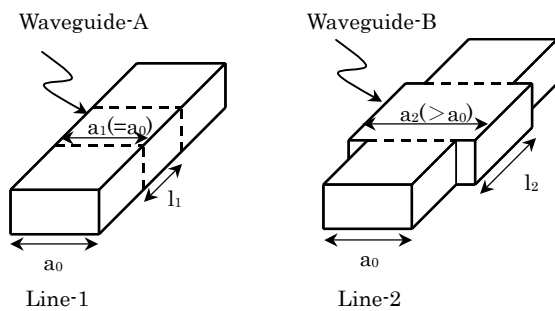

Figure 2: The phase delay line with the phase compensation circuits

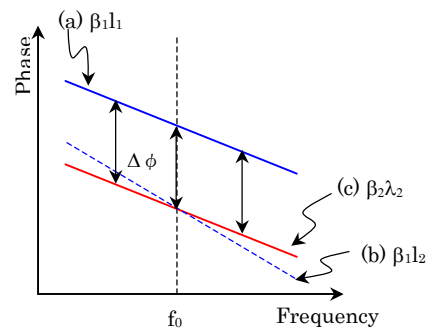

Figure 3: The principle of the phase compensation circuit

4. Design of the phase compensation circuit

The parameters of the phase compensation circuit, length of Waveguide-A l_1 , width of Waveguide-B a_2 and length of Waveguide-B l_2 , can be determined by considering the following condition.

I: Insertion phase difference between Line-1 and Line-2 is $\Delta\phi$ at center frequency (ω_0).

$$\beta_1(\omega_0) \cdot l_1 + \Delta\phi = \beta_2(\omega_0) \cdot l_2 \quad (2)$$

II: Group delay of Line-1 and Line-2 become same around the center frequency.

$$\left. \frac{d}{d\omega} \beta_1 \cdot l_1 \right|_{\omega_0} = \left. \frac{d}{d\omega} \beta_2(\omega) \cdot l_2 \right|_{\omega_0} \quad (3)$$

III: Reflections caused by the step of waveguide width at the both end of Waveguide-B vanishes.

$$\beta_2(\omega_0) \cdot l_2 = n\pi \quad (n=1,2,3,\dots) \quad (4)$$

By using equations (1), (2), (3) and (4), a_2 , l_1 and l_2 can be determined as follows.

$$a_2 = \pi \sqrt{\frac{n\pi - \Delta\phi}{n\pi(\pi/a_0)^2 - \omega_0^2 \varepsilon\mu \Delta\phi}} \quad (5)$$

$$l_1 = \frac{n\pi - \Delta\phi}{\sqrt{\omega_0^2 \varepsilon\mu - (\pi/a_0)^2}} \quad (6)$$

$$l_2 = \frac{n\pi}{\sqrt{\omega_0^2 \varepsilon\mu - (\pi/a_2)^2}} \quad (7)$$

It is noted from above equations, that the design parameter is only n for a given value of $\Delta\phi$. In the case of small n , the value of a_2 becomes large, and the cutoff frequency of higher modes goes down. Oppositely, if a big number is chosen for n , the length of Waveguide-B l_2 becomes long, and the low reflection bandwidth of Line-2 becomes narrow. Hence, the parameter n should be chosen carefully.

5. Simulation and experimental results

Figure 4 shows simulation model and Figure 5 shows picture of the fabricated waveguide monopulse comparator. 3-arm-type branch line hybrid couplers are used as 90° hybrid couplers. Figure 6 shows simulated and measured return losses of SUM port. Figure 7 shows phase difference between two outputs for ΔAz , compared with the simulated characteristic of conventional configuration.

The bandwidth of proposed waveguide monopulse comparator can be 8% for a return loss better than 23dB and for phase difference better than 3.5° while conventional it is better than 12°.

6. Conclusions

In this paper, a waveguide type broadband monopulse comparator using four 90° hybrid couplers and delay lines with phase compensation circuits is proposed. It has been shown that the proposed monopulse comparator has broadband characteristics by simulation and experiment.

References

- [1] G.P.Riblet, "Compact planar microstrip-slotline symmetrical ring eight-port comparator circuits", IEEE Trans. Microwave Theory Tech., vol.MTT-38, PP.1421-1426, Oct.1990.
- [2] T.Kawai, K.Iio, I.Ohta, and T.Kaneko, "A branch-line-type eight-port comparator circuit", in 1991 IEEE MTT-S Int. Microwave Symp. Dig., pp.869-872, June.1991.

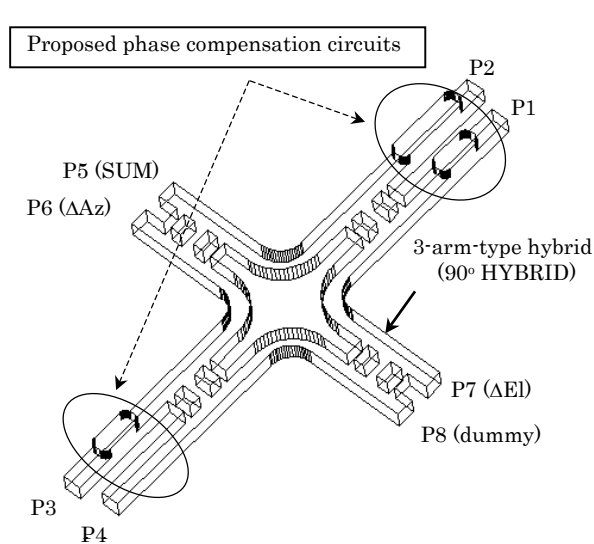

Figure 4: The simulation model of the waveguide monopulse comparator with phase compensation circuits

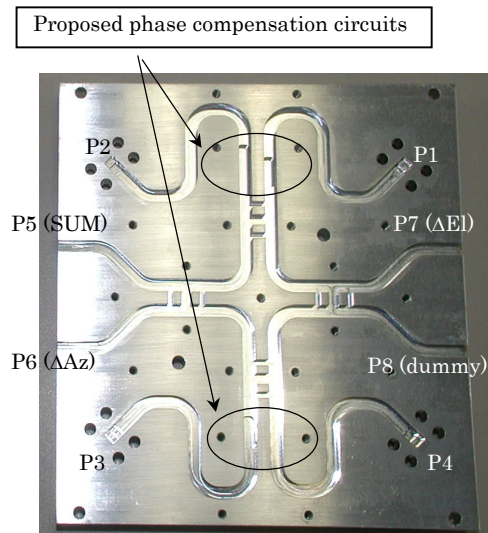

Figure 5: The fabricated waveguide monopulse comparator with phase compensation circuits

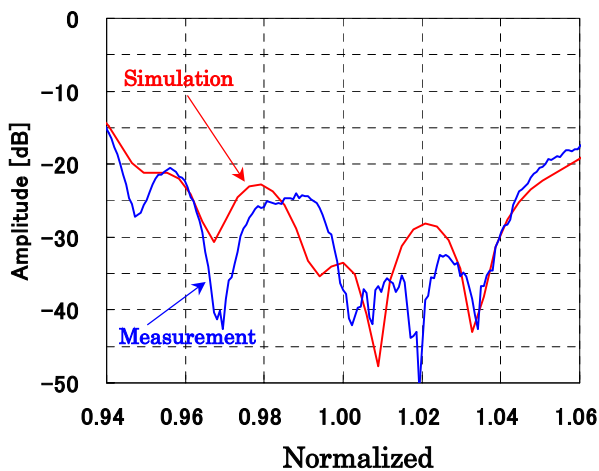

Figure 6: Return loss of SUM port

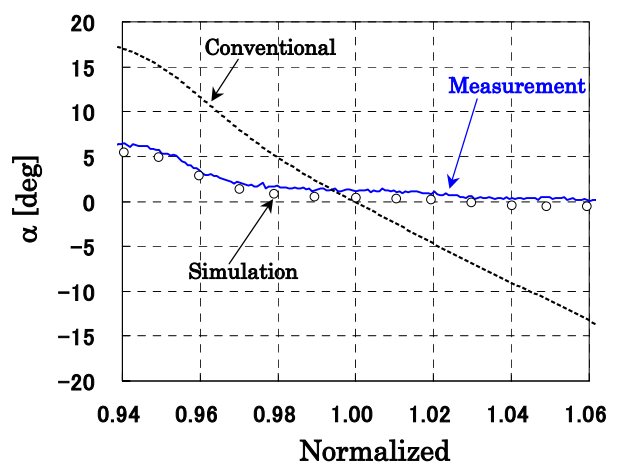

Figure 7: Phase difference of outputs of ΔAz ($180^\circ \pm \alpha$)