

EFFICIENCY IMPROVEMENTS OF NORMAL MODE HELICAL ANTENNAS BY FOLDED CONFIGURATIONS

Woong Hyun Jung, Naobumi Michishita and Yoshihide Yamada
Department of Electrical and Electronic Engineering, National Defense Academy
1-10-20 Hashirimizu, Yokosuka, 239-8686 Japan
E-mail: r04001@nda.ac.jp

1. Introduction

In RFID tags, very small antennas are requested. Here, normal mode helical antennas (NMHA) are thought promising candidates. Extremely small NMHA are used as embedded sensors in wild animals [1]. And ferrite rod antennas in AM receivers are very familiar [2]. In this paper, improvements of antenna efficiencies by employing folded structures are studied. First of all, resonant conditions of original NMHA are discussed. Next, resonant conditions of folded type NMHA are shown. Increases of radiations (R_r) and resistances (R_l) are shown. Finally, improvements of antenna efficiencies are shown.

2. Structural Condition of Small Helical Antenna

Figure 1 shows configurations of original type small helical antennas. In an original type, H and a express the antenna length and radius, respectively. Number of turns is expressed by N . In the case, N is 10. Figure 2 shows resonant conditions of original type helical antennas at 900MHz band. Calculation is conducted through an electromagnetic simulator that uses the Moment Method (FEKO). Currents distributions exhibit simple forms that are tapered to edges as shown in Fig. 1. Interesting thing is that radiuses (a) are hold almost constant. This means that total helical lengths are hold constant in every N number.

Figure 3 shows configurations of folded type helical antenna that the same of original helical antenna conditions. S is interval between both helical antennas. Current distribution is the same type of original helical antenna. Figure 4 shows structural condition of folded type helical antenna. In this case, the self-resonance is realized that the only change of S .

Figure 5 shows radiation and ohmic resistances of original and folded type helical antenna in antenna length of 0.025 to 0.2 wavelengths at 900MHz band. This case is not changed R_l on the change of H , because total helical length is not changed. However, R_r is decreased by H is shortened, not relative N . In the case, R_l and R_r of folded structure are increased by 2 and 4 times that compared by original structure.

Figure 6 shows radiation efficiency and gain of original and folded type antennas. Efficiency (η) of folded structure is increased 2.5 dB, compared by original structure. Gain is increased 5 dB, too.

3. Detailed Characteristics of Folded Type Helical Antenna

Figure 7 shows current distributions of 0.025 wavelength folded type helical antenna. Current amplitudes become large in the 900MHz band. So, this antenna is sensitive near the resonant frequency. Figure 8 shows radiation efficiency and antenna gain. This antenna is near the circular polarization because of Axial ratio is 1.9.

4. Conclusion

Currents distributions of helical antenna exhibit simple forms that are tapered to edges. Although, radiuses (a) are hold almost constant. This means that total helical lengths are hold constant in every N number. And, holed helical antenna is achieved the self-resonance by the only change of interval (S). Folded helical antenna is high efficiency antenna, compared by original type, and the sensitive near the resonant frequency in the 900MHz band.

Acknowledgement

The authors would like to thank Mr. Hirano, Mighty Card Corporation for his valuable suggestions and encouragement.

References

- [1] Klaus Finkenzeller, RFID-Handbuch 2nd edition (Japanese translation), Nikkan Kogyo Simbun, Ltd., pp.331-337, 2004.
- [2] J. D. Klaus, Antennas second edition McGraw-Hill, pp. 259-263, 1988.

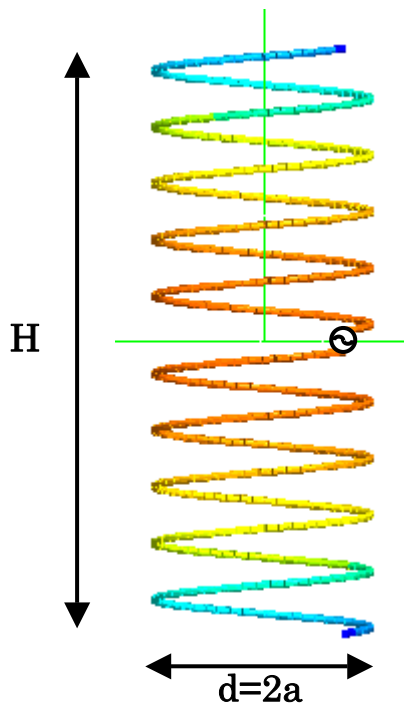

Figure 1 Original type helical antenna and current distribution (N=10)

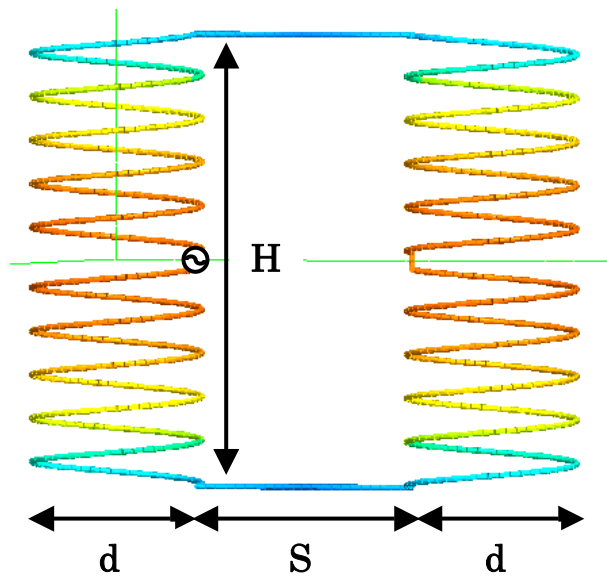

Figure 3 Folded type helical antenna and current distribution

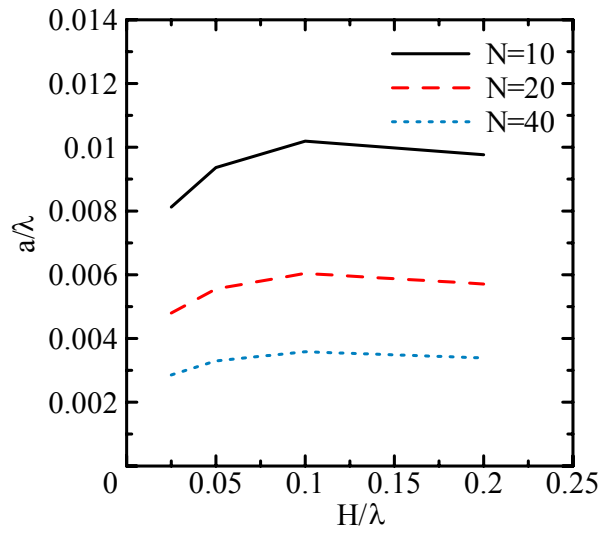

Figure 2 Structural condition of original type helical antenna

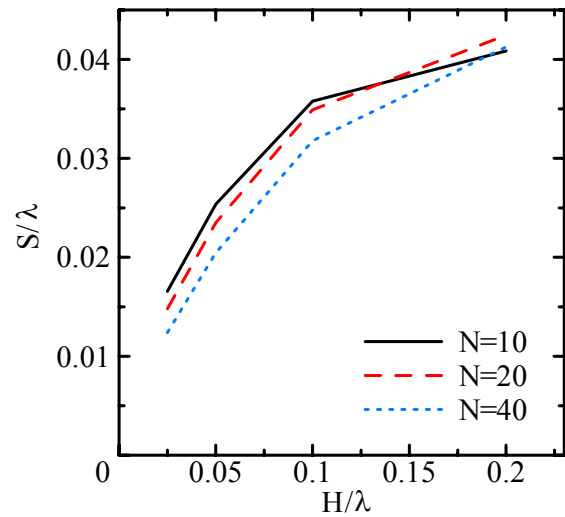

Figure 4 Structural condition of folded type helical antenna

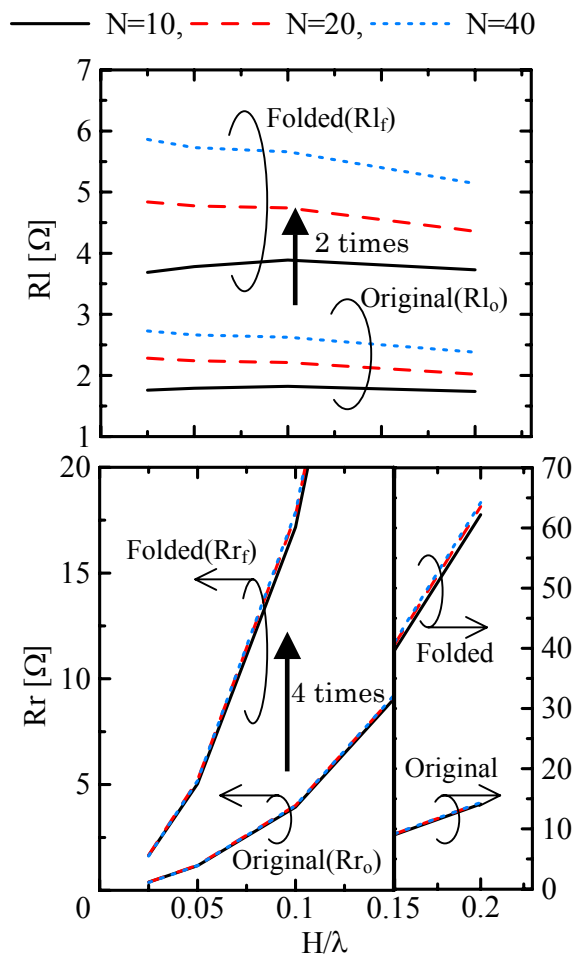

Figure 5 Radiation and ohmic resistances of original and folded type helical antenna

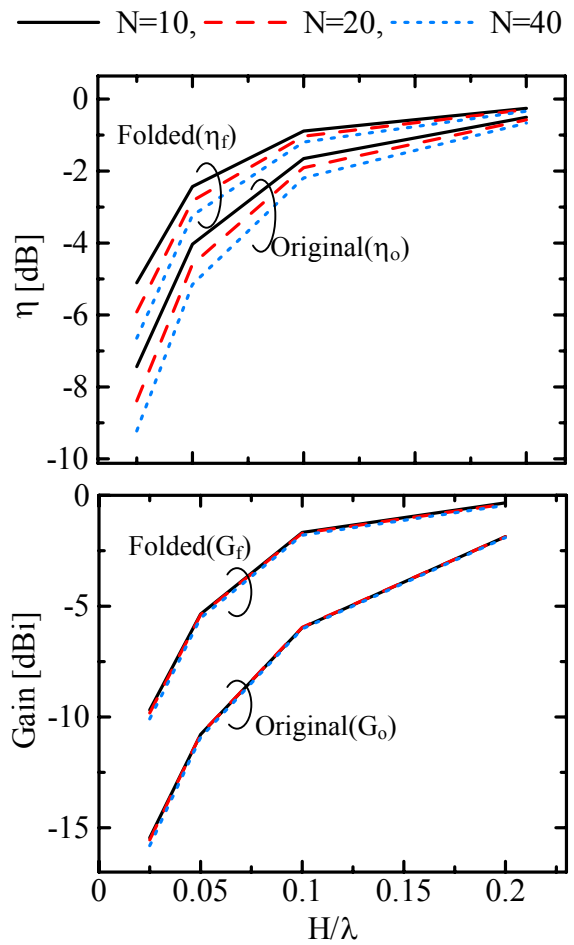

Figure 6 Radiation efficiency and gain of original and folded type antennas

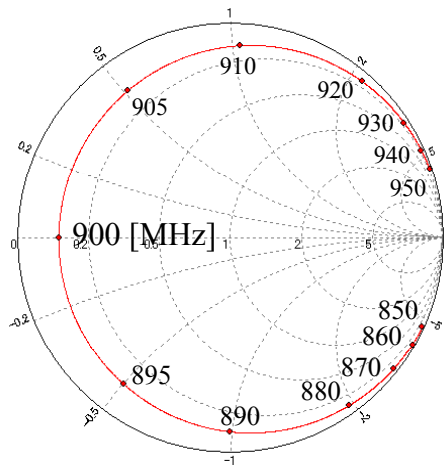

Figure 7 Smith chart of 0.025 wavelength folded type helical antenna

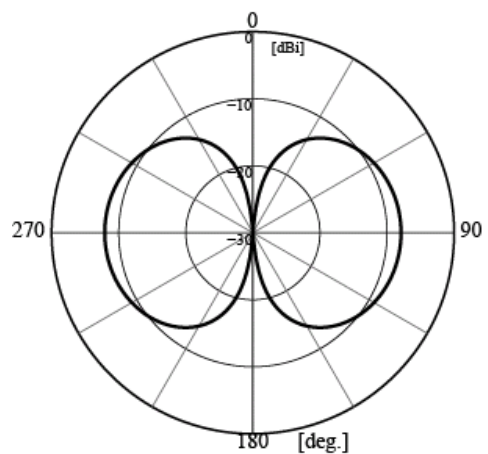

Figure 8 Antenna gain pattern of 0.025 wavelength folded type helical antenna