

**More Results on the Transfer Functions of cross-polarized and Diversity-protected RF-channels**

Markus Liniger, Swiss PTT

### 1 INTRODUCTION

Five years ago, the Swiss PTT started the measurement of the transfer function of RF-channels on several hops in Switzerland. With an extended measurement set-up and an improved data acquisition system, the fourth hop has been under investigation for 1½ years now. The measured signals allow to study the behaviour of individual channels. Beside this, the correlation between the measured quantities can be deduced. First results have been described previously.

### 2 DESCRIPTION OF EXPERIMENT

The experiment has been in progress since August 1983 on a hop of 46.5 km length at frequencies in the upper 6 GHz band. One part measures the transfer functions of the RF-channels (Fig. 1). The RF-signal sweeps over a bandwidth of 60 MHz and is transmitted by a circular parabolic dish antenna (3 m  $\phi$ ) alternately on both polarizations using a latching circulator as a switch. The switch, controlled by the sweep signal, changes every 0.2 seconds between the horizontal and vertical polarization. At the receiver site two parabolic dish antennas were installed. The main antenna (3 m  $\phi$ ) is equipped to receive both polarizations, the diversity antenna (1.2 m  $\phi$ ) only the vertical one. The magnitudes of the three receive signals are fed to the data acquisition system. In addition, the two vertically polarized signals from the main and diversity antenna resp. are combined through an in-phase diversity combiner (STR). A link analyzer measures amplitude and group delay of the combined signal and derives the sweep voltage. The six analog quantities are sampled at a rate of 200 Hz per channel, digitized and collected in a long-term (monthly statistics) and a short-term (special events) data base.

### 3 QUALITATIVE DESCRIPTION OF THE MEASURED DATA

The following examples and results are all taken from the short term data base. As the polarization of the transmitted signal is changed at every sweep from horizontal to vertical and vice versa, real and quasi-simultaneous in-line and cross-polar transfer functions resp. can be derived from the received signals. Figure 2 shows three successive sweeps during a selective fading. The sweeps No. 28 and 30 are vertically transmitted. The vertically received signals are labelled as MAIN VV resp. DIVERSITY VV. The two corresponding horizontally received (cross-polarized) signals are denoted as MAIN VH resp. DIVERSITY VH. The sweep No. 29 represents a horizontally transmitted signal with the in-line receive signal labelled as MAIN HH and the two cross-polarized ones MAIN HV resp. DIVERSITY HV.

Several observations can be made by examining the measured amplitudes:

- the cross-polarized signals show no notches at the frequency where the in-line signals deep fades
- the minima of the in-line signals are below the cross-polarized level
- the minima of the two cross-polarized in-line signals (VV and HH) are not simultaneously at the same frequency.
- The in-line diversity signal is attenuated by 12 dB but shows no distortion.

### 4 STATISTICAL RESULTS

A total of 2.5 Million sweeps, taken during two periods (autumn 83 and 84) of heavy fading, were available for analysis. A polynomial of second degree, namely,  $A(f) = a_0 + a_1 f + a_2 f^2$ , is fitted to the measured received levels in dB. The results are triplets of coefficients ( $a_0, a_1, a_2$ ) for each examined signal. The coefficient  $a_0$  denotes the attenuation at the center of the RF-

channel in dB,  $a_1$  describes the slope in dB/MHz and  $a_2$  the parabolic distortion in dB/MHz<sup>2</sup>. From this data, one can study the behaviour of the single channels and the correlation between the different signals.

#### 41 Cumulative distribution function of the constant terms

The cumulative distribution function of the in-line signals follows the well known  $L^2$  rule (Fig. 3). The cross-polarized received signals show a normal distribution (Fig. 4). The long-term 50% values of the in-line signal are 0 dB, the values of the cross-polarized signal are plotted in figure 4.

#### 42 Distortion in the single channels

Figures 5 and 6 show the probability density function  $p(a_1, a_2 | \text{all } a_0)$  of the signal, vertically received by the main-antenna and vertically or horizontally transmitted. Further results are plotted in Fig. 7 and 8. They show the percentiles of the marginal density functions  $p(a_1(a_0) | \text{all } a_2)$  and  $p(a_2(a_0) | \text{all } a_1)$  respectively. The distribution of the slope remains symmetrical for all fade depths. The distribution of the parabolic distortion shows an increasing 50% value and an asymmetrical density function for deep fades. The same observations can be made by interpreting the probability density functions of the two other in-line signals (MAIN HH and DIVERSITY VV). As an example, the marginal distribution of the slope of the cross-polarized signal MAIN HV is presented in Fig. 9.

#### 43 Correlation between the in-line and the cross-polarized signal

Figure 10 shows the correlation matrix of the linear coefficients (slope) of the vertical in-line signal and the horizontal cross-polarized signal. The logarithm of the density function  $p(a_{1V}, a_{1H} | \text{Tx:vertical})$ , which is depicted in the direction of the third axis, indicates the presence of two subsets of pairs  $(a_{1V}, a_{1H})$ . The more numerous ones form the "long, slender mountain": During weak distortions of the in-line signal the cross-polarized one shows non-correlated distortions with four times steeper slopes. The less numerous ones formed by a circular cone about the center indicate that large linear distortions of the in-line signal are not correlated with the linear distortions of the cross-polarized signal. Similar observations can be made by interpreting Figure 11, which describes the correlation matrix of the parabolic distortions.

#### 44 Correlation between the vertical and the horizontal in-line signal

Results of the quasi-simultaneous measurement of the horizontal and the vertical in-line signals are presented in Figures 12 and 13. The first shows the density function  $p(a_{1V}(t), a_{1H}(t+0.2s) | \text{both in-line})$ , i.e., the joint probability of the quasi-simultaneously measured slope of the vertical and horizontal in-line signals. A slender mountain crosses the plain in the 45° axis and indicates that the two signals are correlated. The parabolic terms (Fig. 13) show less correlation for weak values of  $a_2$ . But deep notches (large positive values of  $a_2$ ) are present at the same time on both polarizations.

#### 45 Correlation between the signals of the main and diversity antennas

The density function  $p(a_{1M}, a_{1D} | \text{both in-line})$  (Figure 14) shows a mountain with a cross-shaped ground plane, which indicates that one polarization has strong linear distortions whilst the other shows practically none and vice versa. Strong simultaneous distortions have not been observed until now. Similar conclusions can be drawn for the parabolic distortions (Figure 15). However, in the corner toward positive values of  $(a_{2M}, a_{2D})$  one can find a subset of correlated events, representing weak simultaneous notches.

## 5 CONCLUSIONS

- the time below level of the in-line signals is Rayleigh distributed.
- the time below level of the cross-polar signals is normal distributed.
- the distortions of the horizontal and vertical in-line signals are similar and correlated.
- the horizontally and the vertically polarized in-line signals are simultaneously affected by multipath fading. More detailed studies show that the notches of deep selective fades are not at the same frequency for any given instant.
- large distortions of the in-line and cross-polarized signals are not correlated
- large distortions of the main and diversity antenna signals are not correlated.

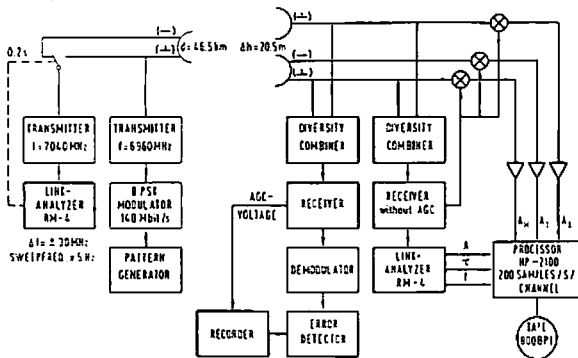

FIGURE 1. BLOCK DIAGRAM OF THE FIELD EXPERIMENT

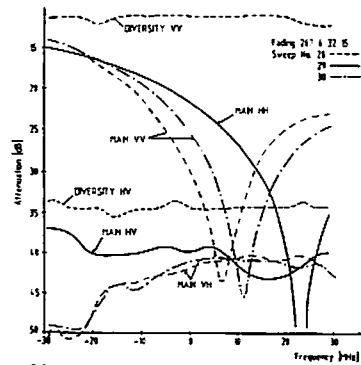

FIGURE 2. EXAMPLE OF SUCCESSIVE SWEEPS

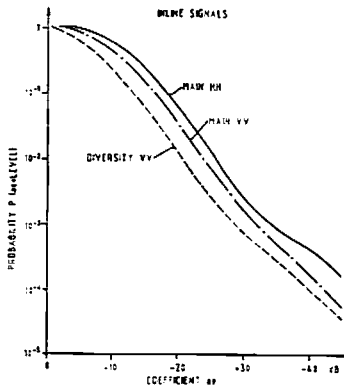

FIGURE 3

PROBABILITY DENSITY FUNCTION OF THE COEFFICIENTS OF THE FIT-POLYNOMIAL ATTENUATION (MAIN-VV, MAIN-VV, DIVERSITY VV) 115.2 MHz, 14.53 m, 70.5 m

MAIN-ANTENNA, VERTICAL, IN-LINE-SIGNAL

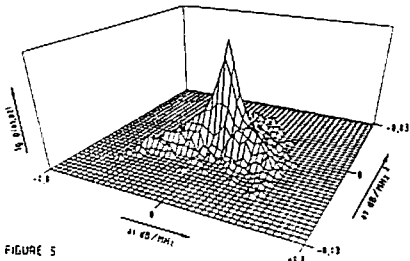

FIGURE 5

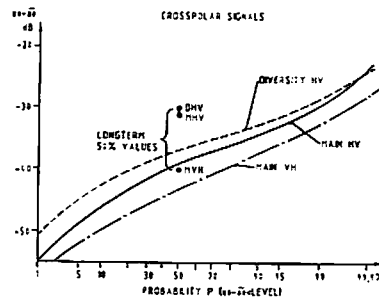

FIGURE 4

PROBABILITY DENSITY FUNCTION OF THE COEFFICIENTS OF THE FIT-POLYNOMIAL ATTENUATION (DIVERSITY HV, MAIN HV, MAIN VH, DIVERSITY VV) 115.2 MHz, 14.53 m

MAIN-ANTENNA, VERTICAL, CROSSPOLAR-SIGNAL

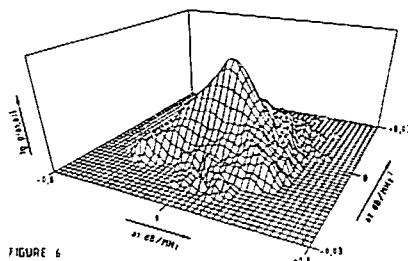

FIGURE 6

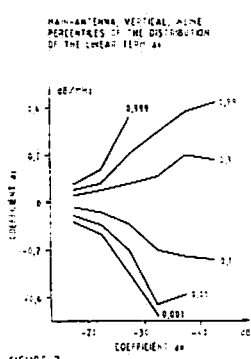

FIGURE 7

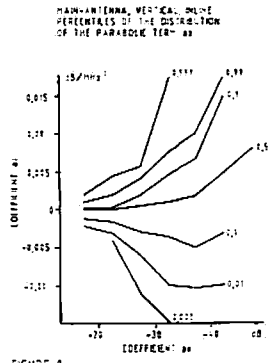

FIGURE 8

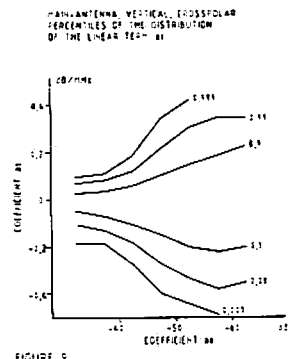

FIGURE 9

COMPARISON 1 SIGNALS FROM THE VERTICAL VS SIGNALS FROM THE HORIZONTAL POLARIZATION (VERTICAL VS HORIZONTAL LINEAR TERMS) CORRELATION MATRIX OF THE LINEAR TERMS OF THE FIT-POLYNOMIALS

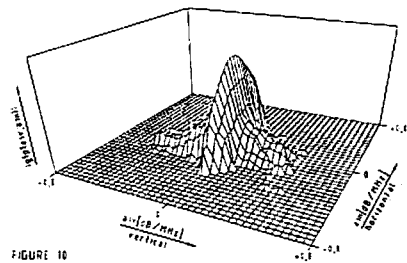

FIGURE 10

COMPARISON 1 SIGNALS FROM THE VERTICAL VS SIGNALS FROM THE HORIZONTAL POLARIZATION (VERTICAL VS HORIZONTAL QUADRATURE TERMS) CORRELATION MATRIX OF THE PARABOLIC TERMS OF THE FIT-POLYNOMIALS

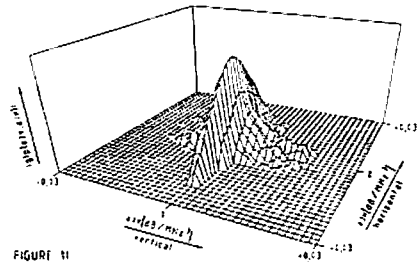

FIGURE 11

COMPARISON 2 SIGNALS FROM THE VERTICAL VS SIGNALS FROM THE HORIZONTAL POLARIZATION (VERTICAL VS HORIZONTAL QUADRATURE TERMS) CORRELATION MATRIX OF THE LINEAR TERMS OF THE FIT-POLYNOMIALS

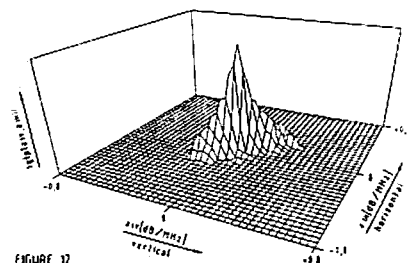

FIGURE 12

COMPARISON 2 SIGNALS FROM THE VERTICAL VS SIGNALS FROM THE HORIZONTAL POLARIZATION (VERTICAL VS HORIZONTAL QUADRATURE TERMS) CORRELATION MATRIX OF THE PARABOLIC TERMS OF THE FIT-POLYNOMIALS

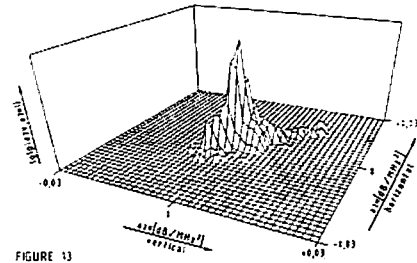

FIGURE 13

COMPARISON 3 SIGNALS FROM THE MAIN VS SIGNALS FROM THE DIVERSITY ANTENNA POLARIZATION (VERTICAL VS VERTICAL) CORRELATION MATRIX OF THE LINEAR TERMS OF THE FIT-POLYNOMIALS

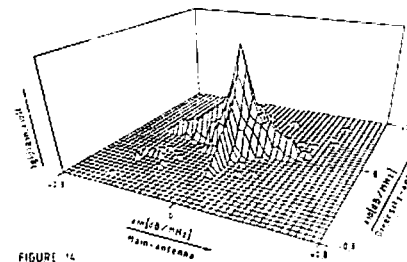

FIGURE 14

COMPARISON 3 SIGNALS FROM THE MAIN VS SIGNALS FROM THE DIVERSITY ANTENNA POLARIZATION (VERTICAL VS HORIZONTAL) CORRELATION MATRIX OF THE PARABOLIC TERMS OF THE FIT-POLYNOMIALS

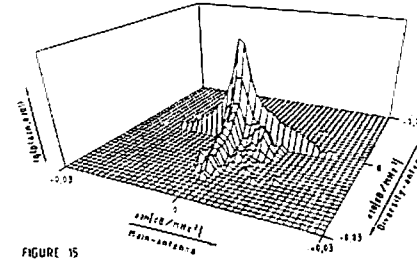

FIGURE 15