

Fast Measurement Technique Using Multicarrier Signal for Transmit Array Antenna Calibration

Kazunari Kihira, Toru Takahashi, and Hiroaki Miyashita
 Information Technology R&D Center, Mitsubishi Electric Corporation
 5-1-1 Ofuna, Kamakura, Japan

Abstract- Calibration is a key technology to realize the desired radiation pattern in phased array antennas. Various techniques have been proposed for array antenna calibrations. The main objective is to obtain the complex electric fields (amplitude and phase) of the individual antenna elements and to compensate for the element-to-element variations. A new technique is required for a fast and efficient measurement operation since the measurement time increases in proportion to the number of antenna elements and/or measurement frequencies. In this paper, we propose a novel measurement method using multicarrier signal for phased array antenna calibration. The proposed method can simultaneously measure the complex electric fields of all antenna elements, therefore fast calibration is possible. The experimental result in an anechoic chamber is also demonstrated.

I. INTRODUCTION

Phased array antennas based on Digital BeamForming (DBF) have been investigated for a variety of wireless systems [1]-[3]. This antenna system, in which the beamforming is performed directly on a digital level, allows the most flexible and powerful control of the radiation pattern of the antenna. Therefore, each radiator (antenna element) must be equipped with its own receiver or transmitter. For proper operation, all channels (antenna plus microwave circuit) of the DBF antenna should exhibit defined amplitudes and phases. Calibration is a key technology to realize the desired radiation pattern. Many measurement techniques have been proposed for phased array calibrations. The main objective is to obtain the complex electric fields (amplitude and phase) of the individual antenna elements and to compensate for the element-to-element variations. Unlike a single-element measurement, where the electric fields of the individual elements are determined with only a single element illuminated, the measurement techniques described in [4]-[8] measure the in-situ electric fields with the entire array radiating and include some error terms such as T/R module variations, feed-circuit variations, mutual coupling, and diffraction due to antenna structures etc.

For phased array calibrations, an important issue is to overcome the large measurement times which increases in proportion to the number of antenna elements and/or measurement frequencies. Thus, it is required for a fast and

efficient measurement operation. In this paper, a novel calibration method using multicarrier signal is proposed. The proposed method can simultaneously measure the complex electric fields of all antenna elements, therefore fast calibration is possible.

In the next section, the principle of the proposed measurement method using multicarrier signals is presented. Section III shows the experimental results in an anechoic chamber and section IV describes the conclusions.

II. PROPOSED METHOD

A. System Configuration

Figure 1 shows the system configuration of the proposed method. Each antenna element is equipped with high power amplifier (HPA), and up-converter (U/C) and digital to analog converter (D/A). In digital signal processing part, it has a function of inverse discrete fourier transform (IDFT), and subcarrier arrangement and multicarrier signal generation for calibration. In receiver, for the measurement of all channels of transmit array antenna, Rx antenna is equipped with low noise amplifier (LNA), and down-converter (D/C) and analog to digital converter (A/D). It has a function of the demultiplexing of subcarriers and calculation of the relative amplitude and phase between antenna elements.

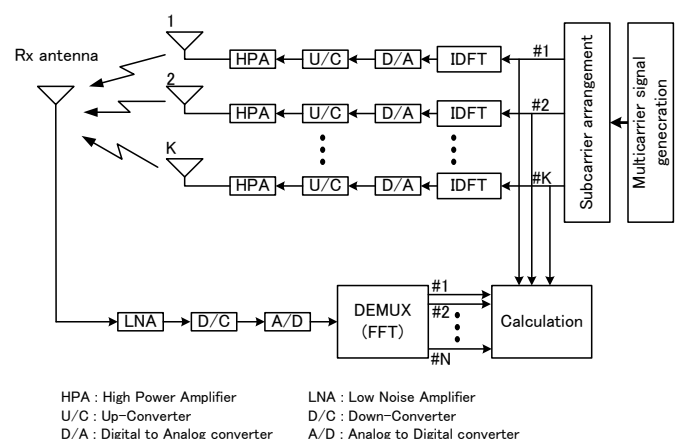

Figure 1. System configuration of the proposed method

B. Procedure in Transmitter

First, a multicarrier signal (called as reference signal) for calibration is generated in transmitter as shown in Figure 2. N signals $c(n)$ ($n=1, 2, \dots, N=MK$) are arranged in a measurement frequency band. K is the number of antenna elements and M is that of measurement frequencies, respectively. The reference signal is designed as an orthogonal frequency division multiplexing (OFDM) signal, that is, each subcarrier is orthogonal to the others.

Next, Subcarrier signals $c(n)$ are assigned to each antenna element by every K as shown in Figure 3. This arrangement can be uniformly assigned subcarriers in the measurement frequency band, and does not produce interference to the reference signal between antenna elements. After that, the reference signal of each antenna element is transformed to the time-domain signal by the inverse discrete fourier transform (IDFT) as follows.

$$s_k(t) = \frac{1}{N} \sum_{n=0}^{N-1} c_k(n) e^{j\frac{2\pi}{N}nt} \quad (1)$$

where

$$c_k(n) = \begin{cases} c(n) & n = k, k+K, \dots, k+(M-1)K \\ 0 & n \neq k, k+K, \dots, k+(M-1)K \end{cases} \quad (2)$$

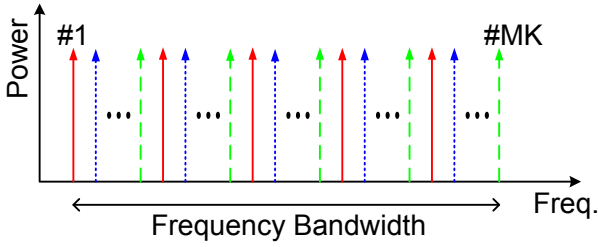

Figure 2. Subcarrier arrangement of the reference signal

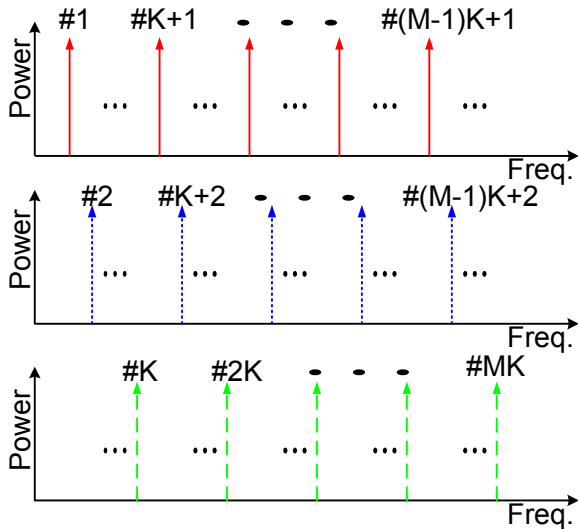

Figure 3. Subcarrier arrangement for each antenna element

C. Procedure in Receiver

The received microwave signal of RX antenna is converted into a complex digital signal on baseband. The signal is transformed to frequency-domain signal by DFT. Since the reference signal of each antenna element is orthogonal to the others, it is easy to separate those signals. Therefore, the relative complex amplitudes are obtained by,

$$\beta_{k,m} = \frac{x(k+(m-1)K)}{c(k+(m-1)K)} \quad (3)$$

where $x(n)$ is the received complex signal after DFT.

III. EXPERIMENTAL RESULTS

A. Measurement Condition

Table 1 shows the measurement conditions in an anechoic chamber. The proposed measurement method is evaluated with some radiation patterns after calibration. To compare with the proposed method, the results of the single-element and single-frequency measurement method (conventional method) are also shown. The transmit power are the identical values for each antenna element in both methods. The proposed method can reduce measurement time to 1/48 compared with the conventional one.

TABLE I
Measurement conditions

Array configuration	16 element linear array
Element spacing	0.76 [wavelength]
Center frequency	2.185 [GHz]
Data size for calibration	2^{18} [sample]
Subcarrier interval	2.5 [kHz]
Number of subcarrier each element	3
Frequency bandwidth	10 [MHz]

B. Spectrum of Received Reference Signal

Figure 4 shows the spectrum of the received signal for measuring by the proposed method. It turns out that subcarriers are in three points (0MHz and ± 5 MHz). Furthermore, Figure 5 is a figure which expanded near 0 MHz of Figure 4. It turns out that the subcarriers of each antenna element are detectable at intervals of 2.5 kHz.

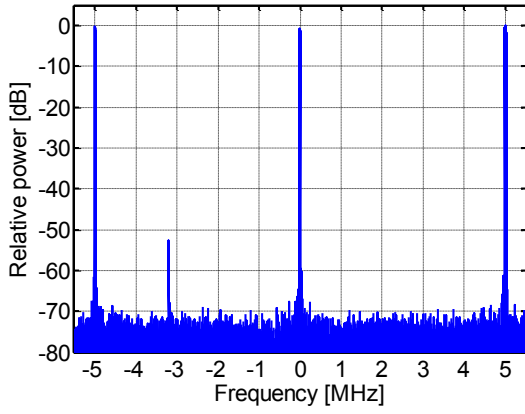

Figure 4. Spectrum of the received signal

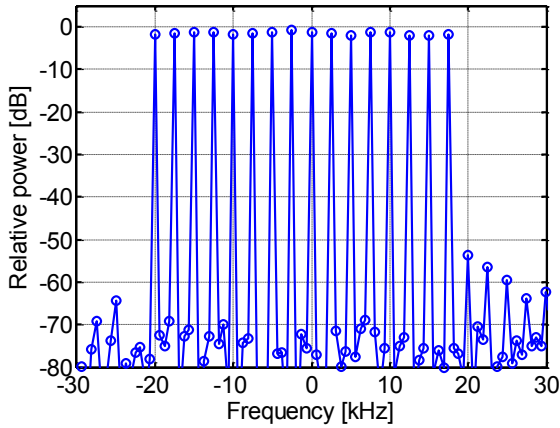

Figure 5. Spectrum of the received signal (expanded near 0MHz)

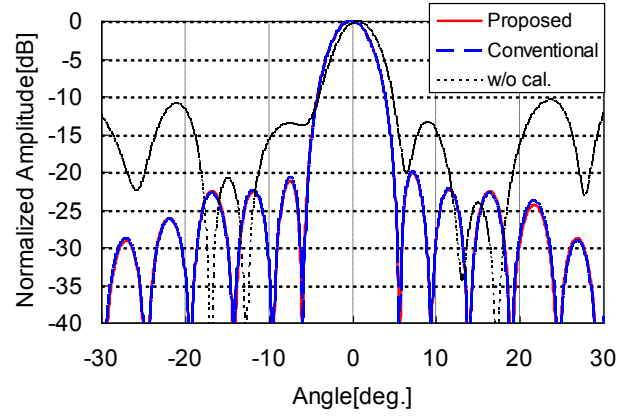

Figure 6. Radiation pattern (2.185GHz)

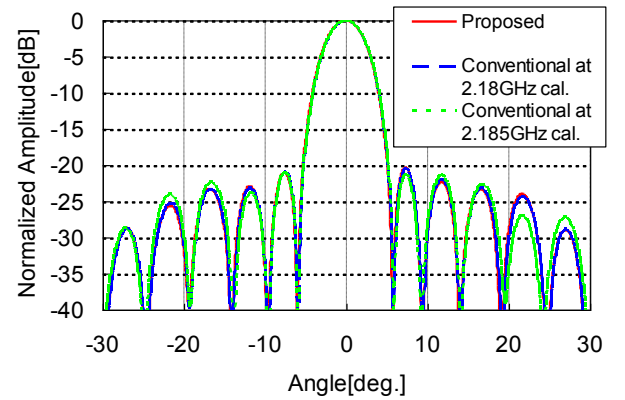

Figure 7. Radiation pattern (2.18GHz)

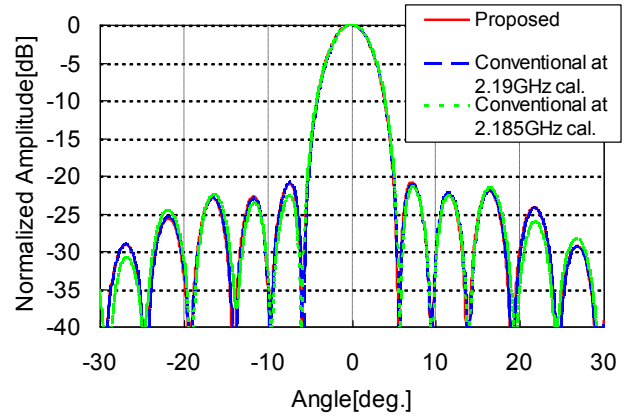

Figure 8. Radiation pattern (2.19GHz)

C. Radiation Pattern

Figure 6 shows the measured radiation pattern at center frequency (2.185GHz). The nominal excitation amplitudes and phases of each antenna element were designed to form a main lobe to 0 degree and to achieve a sidelobe level of -20dB. The pattern before calibration (w/o cal.) causes the beam pointing error and the sidelobe level is very high. On the other hand, the pattern using the proposed method has good performance corresponding to the nominal design. The result of the proposed method and that of the single-element method are in good agreements. Therefore, the proposed measurement method is experimentally validated.

Figure 7 shows the radiation patterns at the lower frequency. The result of the proposed method and that of the single-element method at 2.18GHz measurement also are in good agreements. In conventional method, when using the measurement values at the center frequency (2.185GHz), the sidelobe characteristic has deteriorated. Thus, the proposed method that can simultaneously measure the complex electric fields of multiple frequencies is very effective. Figure 8 also shows the radiation patterns at the higher frequency.

IV. CONCLUSIONS

A fast measurement technique for phased array antenna calibration was presented. The approach exploits multicarrier signal to execute all elements simultaneously, which makes the

method N times faster than single-element measurement, where N is the number of the products of antenna elements and frequency points. Moreover, measured results demonstrated the effectiveness of the proposed method.

REFERENCES

- [1] H.Steyskal, "Digital Beamforming Antennas - An Introduction," *Microwave Journal*, vol.30, no.1, pp.107-124, Jan. 1987.
- [2] J. Litva and K. Y. Lo, *Digital Beamforming in Wireless Communications*, Artech House, 1996.
- [3] A.Garrood, "Digital Modules for Phased Array Radar," *IEEE International Radar Conference, RADAR-95*, 1995.
- [4] S. Mano and T. Katagi, "A method for measuring amplitude and phase of each radiating element of a phased array antenna," *Trans. IECE*, vol. J65-B, no. 5, pp. 555-560, May 1982.
- [5] K.M.Lee, R.S.Chu, and S.C.Liu, "A built-in performance monitoring/fault isolation and correction (PM/FIC) system for active phased-array antennas," *IEEE Trans. Antennas Propag.*, vol.41, pp.1530-1540, Nov. 1993.
- [6] G.A.Hampson and A.B.Smolders, "A Fast and Accurate Scheme for Calibration of Active Phased-Array Antennas," *IEEE AP-S Int. Symp. Digest*, pp.1040-1043, 1999.
- [7] S.D.Silverstein, "Application of Orthogonal Codes to the Calibration of Active Phased Array Antennas for Communication Satellites," *IEEE Trans. SP.*, vol.45, no.1, pp.206-218, Jan. 1997.
- [8] T.Takahashi, Y.Konishi, S.Makino, H.Ohmine and H.Nakaguro, "Fast Measurement Technique for Phased Array Calibration," *IEEE Trans. Antennas Propag.*, vol.56, no.7, pp.1888-1899, July 2008.