

# A Beam Steerable Plane Dielectric Lens Antenna

Yingsong Zhang<sup>1,2</sup>, *Member, IEEE*. and Wei Hong<sup>1</sup>, *Fellow, IEEE*. Yan Zhang<sup>1</sup>, *Member, IEEE*.

1, State Key Laboratory of Millimeter Waves, Department of Radio Engineering,  
Southeast University, Nanjing 210096. P. R. China

2, Institute of Communication Engineering, PLA University of Science and Technology, Nanjing 210007

[yszhang@emfield.org](mailto:yszhang@emfield.org), [weihong@seu.edu.cn](mailto:weihong@seu.edu.cn)

**Abstract-** A planar dielectric lens is designed, and the performance is simulated with HFSS. The performances of plane layers dielectric lens antenna are analyzed when microstrip patch antenna is adopted as the feeding antenna. The influence of the distance from the lens to feeding antenna is discussed. The deviation from the central axis and the unparallel between the feeding antenna and the lens towards the lens antenna are investigated. A beam steerable plane dielectric lens antenna is achieved. The maximum gain of the lens antenna is about 17.43 dB which is about 9.07 higher than that of the patch antenna and the feeding antenna is allocated flexible.

## I. INTRODUCTION

The conventional Luneburg lens is sphere symmetrical structure. The dielectric is radial, which decreases from centre of the sphere to the edge of the sphere. That makes a high consistency between the multi-beams<sup>[1],[2]</sup>. But the symmetrical distribution of the dielectric leads to that it is difficult to fabricate. So some transformative Luneburg lens have been attached importance by the researchers recently. A sliced spherical Luneburg lens (SLL) is proposed<sup>[3]</sup> easy to manufacture. The idea was to drill radial holes in a homogeneous dielectric substrate in such a way that their radii change with position in the substrate in order to produce an approximation of the continuous Luneburg distribution. Afterwards all the substrates are cascaded into Luneburg lens. But the air slot between layers impacts on the lens performance. Using in a polymer-jetting rapid prototyping technique the gradient permittivity is realized by the filling ratio of a polymer<sup>[4]</sup>. Recently a nanostructure Luneburg lens is investigated. The lens used electron beam lithography on silicon on insulator wafer with Hydrogen silsesquioxane as the resist material and mask for reactive ion etching of the silicon structure layer<sup>[5]</sup>. The designs showed high-directivity, low FSLL, and steering capabilities outperforming other antenna systems in the literature<sup>[6]</sup>.

In this paper, a plane dielectric lens antenna is proposed and investigated. The lens is easy to fabricate and possess good performance such as: high directivity, the flexible location for the feeding antenna, and insensitive to the declination of the feeding antenna.

TABLE I  
PARAMETERS OF THE PLANE LENS

Layers	Relative Dielectric Constant	Radius (mm)
1	12	17
2	7.4	25.7

3	6.8	34
4	4.8	38
5	6.2	44
6	2	49

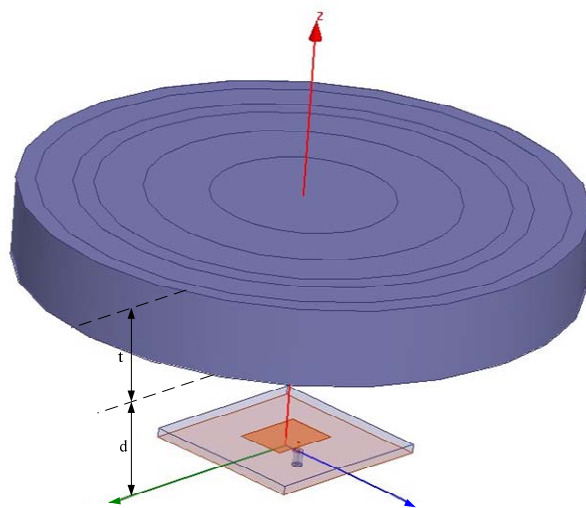

Figure 1. The structure of the plane lens antenna

## II. DESIGN OF THE LENS ANTENNA

### A. Structure of the Lens

Fig. 1 shows the structure of the plane lens antenna. Taking into account manufacturing limitation, the lens is discretized into 6 layers. The thickness of lens is  $t$ . A patch antenna operating at 10 GHz with dimensions  $11.9\text{mm} \times 9\text{mm}$  is used as feeding antenna, and is designed on the dielectric substrate with a thickness of 1.6 mm and a relative permittivity of 2.2. The patch antenna emits a spherical-like wave, which is transformed in the lens, and a high directive beam achieves. The distance from feeding antenna to the lens is  $d$ .

The size of lens is about  $3.2\lambda_0$ .

The relative dielectric constant and radius of each layer are listed in TABLE I.

### B. Performances

Fig. 2 gives S11 of the patch antenna and lens antenna, when the distance between patch antenna and lens is  $\lambda_0$ . The bandwidth of the lens antenna is wider than patch antenna, but reflection creases because of the discretizing for the lens makes that every dielectric layer is weakly reflecting the incident wave.

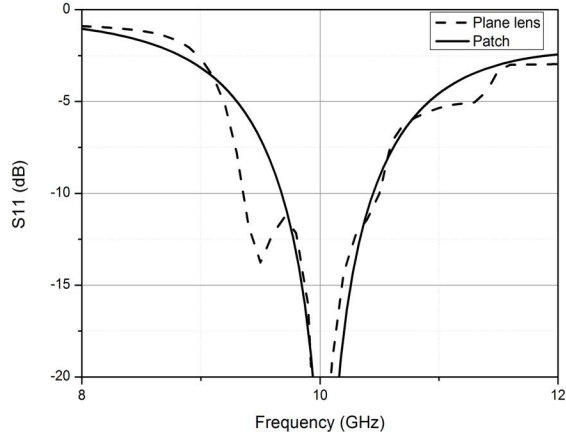

Figure 2. S11 of the patch antenna and lens antenna.

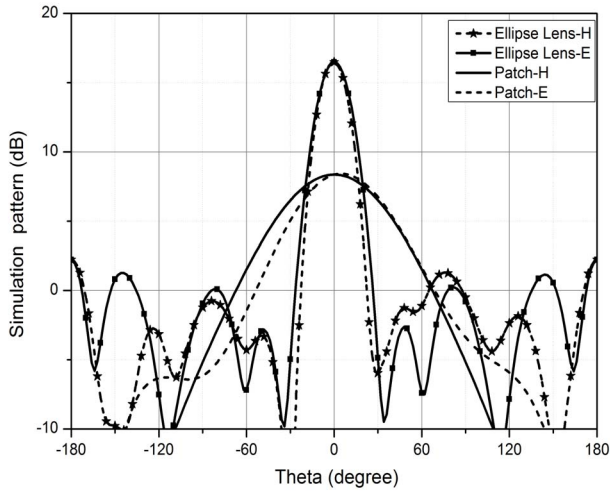

Figure 3. Comparison of the E-plane and H-plane pattern between patch antenna and lens antenna.

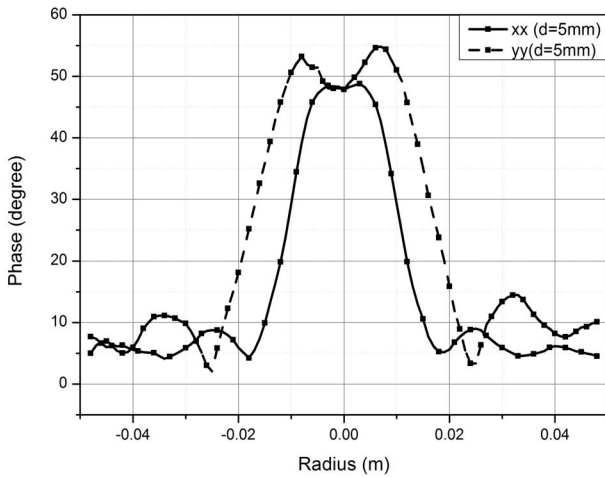

Figure 4. The phase distribution on XX=5mm and YY=5mm cross the lens.

Fig. 3 represents the E-plane and H-plane pattern of the patch antenna and the lens antenna for comparison. The maximum gain of the patch antenna is about 8.36 dB. With electromagnetic wave converging when breaking through the lens, the gain of the lens antenna is strengthened. The maximum gain of the lens antenna is about 17.43 dB which is about 9.07 dB higher than that of the patch antenna accompanying with a narrower beam width for E-plane and H-plane. In TABLE II the performances comparison of the two antennas are listed.

TABLE II  
PERFORMANCES OF THE PLANE LENS ANTENNA AND THE PATCH ANTENNA

Performance	Patch antenna with lens	Patch antenna
Gain(dB)	17.43	8.36
E-HPBW	22°	78°
H-HPBW	22°	54°
E-FSLL(dB)	19.11	-
H-FSLL(dB)	16.7	-

The phase velocity is variation when the dielectric constant is different in different dielectric lens location. The higher of the dielectric constant is, the slower of the phase velocity is. Thus the wave front of the lens is approximately a plane front which makes the energy propagates ahead on an equal footing. This is the primary cause for the lens antenna with high gain.

In Fig. 4 the phase distribution on line XX and YY at  $d=5\text{mm}$  across the dielectric lens is described. For the inconformity of the radiation pattern of the patch antenna on xoz plane and yoz plane, the phase distribution is also different. In the x direction for a radius of about 17mm, the phase fluctuation is about 48 degrees, but from -6mm to 6mm there is hardly no fluctuation. In y direction the phase fluctuation radius is slightly larger than that of x direction, for a radius of about 20mm, the phase fluctuation is about 50 degrees, but from -10mm to 10mm the phase fluctuation is about 6 degrees. In this range of the planar lens there is only a single high dielectric. It is not enough for the phase adjustment, which can be resolved to increase the number of hierarchical lens, but the more layers, the design industry will be more complicated. Outside the above range, the phase fluctuation is about 10 degrees which is so small to be ignored.

### III. BEAM STEERABLE PERFORMANCE

#### A. The Lens Focal Length

Focal length of the lens greatly affect its performance. Figure 5 gives the maximum gain as the distance increases between the feeding and the dielectric lens. With the distance increasing, the maximum gain increases until  $f = 35\text{mm}$ . In the range from 20mm to 45mm the focal length, the maximum gain of the lens antenna is greater than 17 dB. With the increasing of the focal length exceeding 35mm, the gain decreases for the lens being small to cover the 3 dB beamwidth of E-plane and H-plane of the patch antenna.

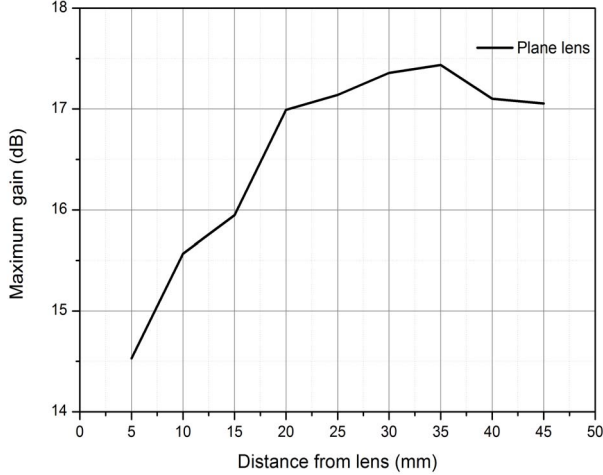

Figure 5. The maximum gain of the lens antenna when the distance from lens to feeding antenna is increases.

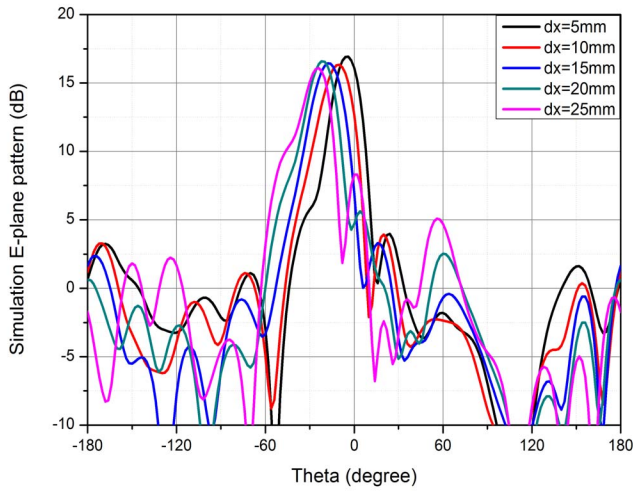

Figure 6. The E-plane pattern of the lens antenna when the feeding antenna is moved along x direction.

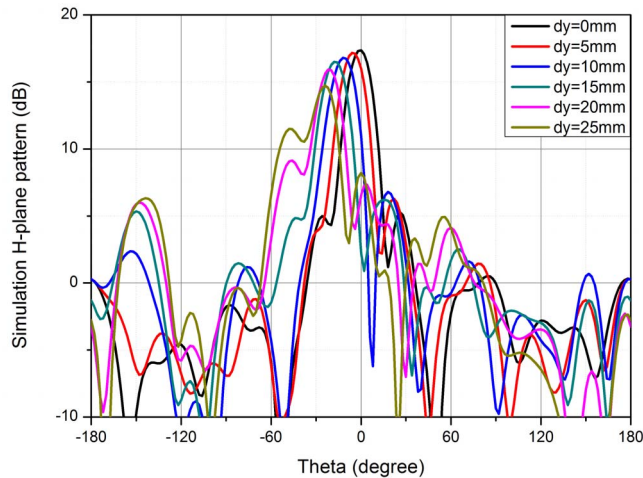

Figure 7. The H-plane pattern of the lens antenna when the feeding antenna is moved along y direction.

### B. Axial Displacement

When the feeding antenna (or the lens) is moved along the axes by a distance, the main lobe of the directivity steers at an angle as plotted in Fig. 6 and Fig. 7. Fig. 6 shows the E-plane pattern with the feeding antenna displacement along the x direction. When the displacement is less than 5mm, its main beam is consistent with that of no offset. With the displacement increases, the lens antenna maximum gain decreases, and the greater the feeding antenna offset is, the level of the side lobes is higher for the lens edge diffracting more energy. When the offset reaches 15mm ~ 20mm the lens antenna main lobe will expand, and then increase offset pattern and restore the original shape, but the gain has fallen only about 1 dB. When the offset exceeds 25mm, the gain of the lens antenna reduces rapidly.

Since three-dimensional distribution of the feeding antenna is not rotational symmetry, its beam shift is not the same for displacement of the feeding antenna in x, y direction. Fig. 7 shows the H-plane pattern with the feeding antenna displacement along the y direction. With the Y-direction offset increases the main lobe directivity deviates from the normal directivity, and the maximum gain decreases gradually accompany with the side lobe level increasing.

### C. Angular Deflection

When there is a certain angle between feeding antenna plane and the lens plane, the lens antenna radiation characteristics will be affected. For convenience of discussion, maintaining the feed antenna to the axis of the lens, the feed antenna plane is deflected toward the x- direction. Fig. 8 gives the E-plane and H-plane patterns for different deflection angle. the antenna maximum deflection  $\pm 25$  degrees. The maximum radiation direction is not the same as pre-deflection, but still normal to lens. The maximum gain margin change is not obvious. Feeding antenna along the x- deflection angles caused only a H-patterns side lobe level changes. Deflecting from negative to positive the side lobe level rises gradually.

## IV. CONCLUSION

This paper presents a design of hierarchical planar dielectric lens. The distance from the feeding antenna to lens, the offset of the feeding antenna deviating from the axis of the lens, feed angle between the feeding antenna and the lens are analyzed in detail. Concluded that, with increasing distance from the feed to the lens, the maximum gain of the lens antenna increases, with increasing offset from the center axis of lens the deflection of the main lobe increases largely, while the maximum gain is reduced, the feed angle between the antenna and the lens changing do not affect the basic radiation performance such as pattern shape and the maximum gain basically unchanged. The structure of the lens antenna is simple, easy to process. and the lens obtains high gain.

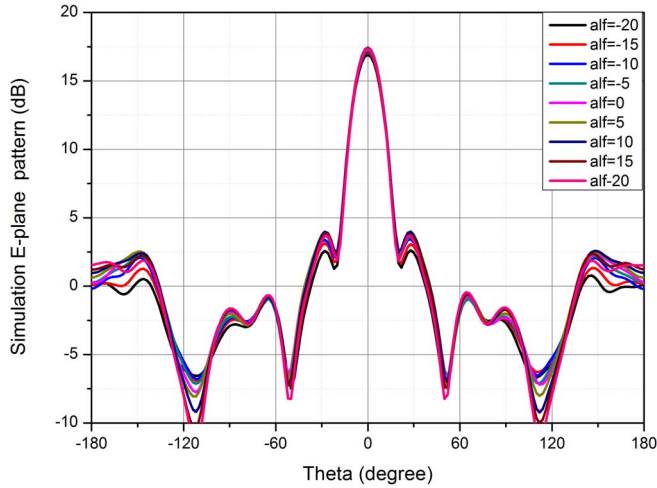

(a) E-plane pattern

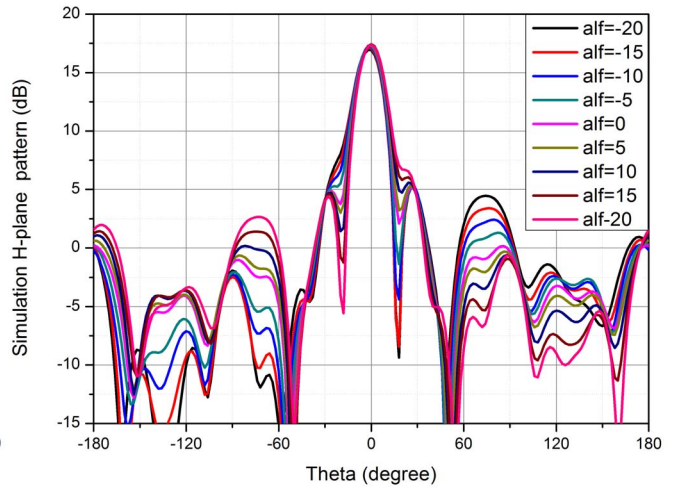

(b) H-plane pattern

Figure 8. The pattern of the lens antenna when the feed antenna plane is deflected toward the x- axis.

### References

- [1] Schoenlinner B. , Wu X. . Wide-scan Spherical-Lens Antennas for Automotive Radars. *IEEE TranS. on MTT* 2002, VOL 50, Num. 9, pages 2166-2175.
- [2] B. Fuchs, Olivier L. , S. Palud, L. Le Coq, M. Himdi, Design Optimization of Multishell Luneburg Lenses. *IEEE TRANSACTIONS ON ANTENNAS AND PROPAGATION*, VOL. 55, NO. 2, FEB. 2007. Pp: 283-289.
- [6] A. Demetriadou and Y. Hao, A Grounded Slim Luneburg Lens Antenna Based on Transformation Electromagnetics. *IEEE ANTENNAS AND WIRELESS PROPAGATION LETTERS*, VOL. 10, 2011. PP: 1590-1593.
- [3] Rondincau S. , Himdi. M. , Sorieux J. . A sliced spherical Luneburg lens. *IEEE Antennas and Wireless Propagation Letters*, 2003, Vol. 2, Issue 1, pp: 163-166.
- [4] M. Liang, W. R. Ng, K. H. Chang, M. E. Gehm and H. Xin, An X-Band Luneburg Lens Antenna Fabricated by Rapid Prototyping Technology.
- [5] Satoshi Takahashi, Chih-hao Chang, Se Young Yang, Design and Fabrication of Dielectric Nano-structured Luneburg Lens in Optical Frequencies. *2010 International Conference on Optical MEMS & Nanophotonics*. PP: 179-180.