

## CIRCULAR POLARIZED CHIP ANTENNAS FOR 5 GHz ISM-BAND APPLICATION

Chia-Lun Tang

Industrial Technology Research Institute

Computer &amp; Communications Research Laboratories

M400, CCL/ITRI Bldg. 14, 195 Sec. 4, Chung Hsing Rd.

Chutung, Hsinchu 310, Taiwan

E-mail: [allentang@itri.org.tw](mailto:allentang@itri.org.tw)

## 1. Introduction

Recently, the practical utilization in WLAN is booming and is rapidly expanding their application scopes. The wireless communication products, such as wireless LAN or PDA terminals, have been realized to reduce the size and weight by the miniaturization and integration of RF devices. So it would be very desirable that chip-type antennas with small size and surface mountable are required. In this paper, we propose novel CP chip antenna designs, which are satisfied such size and suitable for WLAN applications. With the use of CP radiation, the antenna can overcome the problem of multipath fading and no strict orientation among the wireless communication equipments is required [1]. Details of the designs with the CP chip antennas and experimental results are presented and discussed.

## 2. Single-Band Circular Polarized Chip Antenna Design

In this paper, the circular polarized chip antenna is implemented using LTCC (low temperature co-fired ceramic) technology. The LTCC processing has with 19 ceramic layers, and the thickness ( $h$ ) of each layer is 3 mil, or total thickness is 57 mil. First, the single-band circular polarized chip antenna with a CP tuning stub [2] is shown in Fig. 1(a). The square patch has a side length  $L$ , and is embedded in ceramic body (print on the layer 2). With the proper stub length, the resonant mode in the direction parallel to the stub can have a slightly lower resonant frequency than in direction perpendicular to the stub orientation. In this case, the tuning stub is made up of two narrow metal strips which are separately printed on layer 1 and layer 2 and connected by a via. The upper metal strip of length  $l$  and width  $w$  is placed on surface of the chip antenna, and the lower metal strip of length  $s$  and width  $w$  is printed on layer 2. By following this design, the tuning stub can be easily adjusted for CP operating. For the feed position at point  $(x_p, y_p)$ , the two near-degenerate orthogonal modes can have equal amplitudes and a  $90^\circ$  phase difference, and CP operation can thus be obtained. The dimensions of the chip antenna ground plane are  $480 \text{ mil} \times 480 \text{ mil}$ . The proposal antenna has smaller size and surface mounted advantages that can easily integrate on PCB, shown in Fig. 2. The test PCB size is  $1600 \text{ mil} \times 1600 \text{ mil}$  and RF-4 is assumed to be used. With two different lengths of patch ( $L$ ), 366 mil (Antenna 1) and 330 mil (Antenna 2), the single-band CP chip antenna can be designed for 5.2 GHz and 5.8 GHz ISM-band WLAN applications. The proposed antenna design parameters and measured return loss are presented in Fig. 3, and the detailed measured data are listed in Table 1. The measured impedance bandwidths of two cases are larger than 5.0%, and the 3-dB axial ratio are at about 0.9%. Fig. 4 shows the measured radiation patterns for two CP chip antennas at center frequency. Both antenna designs have the broadside patterns and good right-hand CP radiation. The antenna gains of Antenna 1 and 2 are the same at about 3.3 dBic.

Table 1: CP performance of the single-band CP chip antennas (Antenna 1 and Antenna 2): parameters are given in Fig. 2. The impedance bandwidth is determined from 7.3-dB return loss ( $VSWR \leq 2.5$ ).

	$L$ (mil)	Center Frequency (MHz)	Impedance Bandwidth (MHz, %)	3-dB Axial-Ratio CP Bandwidth (MHz, %)	Antenna Gain (dBic)
Antenna 1	366	5275	265, 5.0	48, 0.9	3.3
Antenna 2	330	5750	300, 5.2	55, 0.9	3.3

### 3. Dual-Band Circular Polarized Chip Antenna Design

Fig. 1(b) shows the geometry of a dual-band CP chip antenna (Antenna 3) for 5 GHz ISM-band application. Dual-band operation by using stacked patches [3] is easily implemented by multilayer ceramic structure (with LTCC technology). Two stacked patches are embedded in ceramic body and individually printed on layer 2 and layer 10. The length of upper and lower square patches are 360 mil ( $L_u$ ) and 352 mil ( $L_l$ ), respectively. By choosing the proper tuning stub length and the feed position, dual-band CP radiation can be obtained. The measured return loss of the proposal antenna is shown in Fig. 3. It is clearly observed two operating bands with CP radiation, included 5.2 GHz and 5.8 GHz ISM-band, are excited. The impedance bandwidth of lower operating band, determined from 7.3-dB return loss, is about 4.3%, and the impedance bandwidth for upper operating band is about 1.9%. The detailed antenna performance is listed in table 2. The measured radiation patterns are shown in Fig. 5 for the operating bands at 5.3 GHz and 5.8 GHz. It can be seen that good right-hand CP radiation patterns for both bands is obtained. The antenna gain is at about 3.0 dBic at center frequency 5.3 GHz, that is almost the same as single-band CP chip antenna design. At the upper operating band, the antenna gain is smaller at about 0.5 dBic, which is probably the energy is not having a good coupling between two stacked patches. This can be improved the antenna gain by adjusting the distance of two patches, and it will be studied later.

Table 2: CP performance of the dual-band CP chip antenna (Antenna 3): parameters are given in Fig. 2. The impedance bandwidth is determined from 7.3-dB return loss ( $VSWR \leq 2.5$ ).

	Center Frequency (MHz)	Impedance Bandwidth (MHz, %)	3-dB Axial-Ratio CP Bandwidth (MHz, %)	Antenna Gain (dBic)
5.2 GHz band	5300	225, 4.3	45, 0.8	3.0
5.8 GHz band	5800	110, 1.9	10, 0.2	0.5

### 4. Conclusion

Novel designs of the signal-band and dual-band CP chip antennas by using LTCC technology have been demonstrated. With the tuning stub and multilayer ceramic designs, a good CP performance and smaller size chip antenna can be easily achieved. The total size of the proposed antennas are about 480 mil  $\times$  480 mil  $\times$  57 mil. The CP chip antennas are useful for 5 GHz WLAN applications. In this paper, the single-band CP chip antenna, with the 3-dB axial-ratio CP bandwidth greater than 0.9% and antenna gain at about 3.3 dBic, has been obtained. The dual-band CP chip antenna, with dual-band operating included 5.2 GHz and 5.8 GHz bands, has also been achieved for the case with stacked patches. The impedance bandwidths of dual operating mode are satisfied, and furthermore good CP radiation characteristics have also been observed. The proposed CP chip antennas have potentially applications in wireless communication products.

### References

1. K. L. Wong, *Planar Antennas for Wireless Communications*, John Wiley & Sons, New York, 2003.
2. K. L. Wong and Y. F. Lin, "Circularly polarized microstrip antenna with a tuning stub," *Electron. Lett.*, vol. 34, pp. 831-832, 1998.
3. S. A. Long and M. D. Walton, "A dual-frequency stacked circular-disk antenna," *IEEE Trans. Antennas Propagat.* Vol. 27, pp. 270-273, 1979.

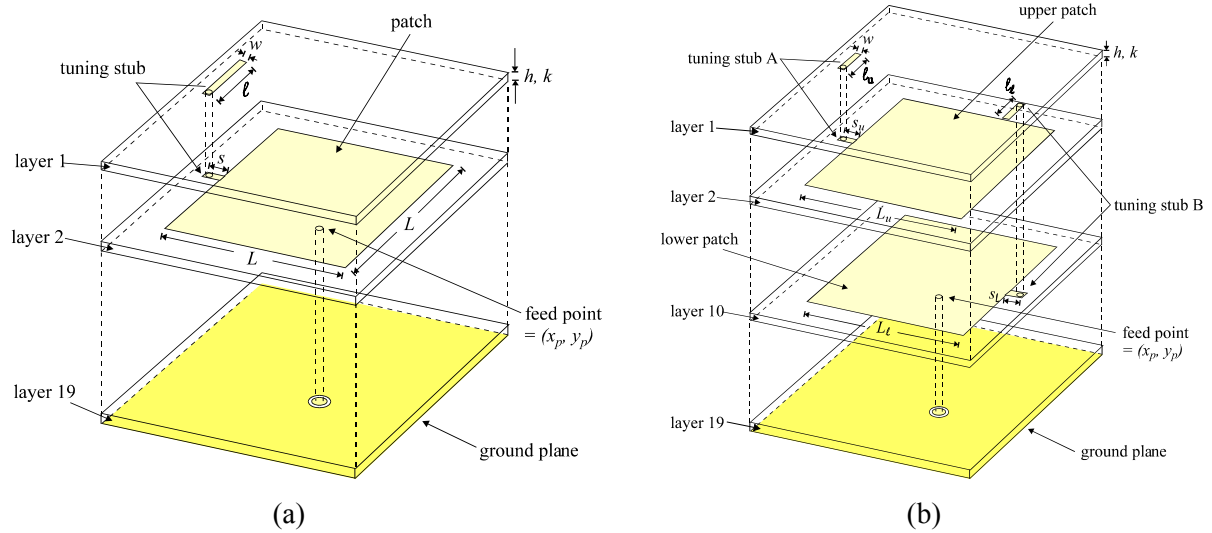

Fig. 1 Geometry of the proposed antennas: (a) Single-band CP chip antenna; (b) Dual-band CP chip antenna.

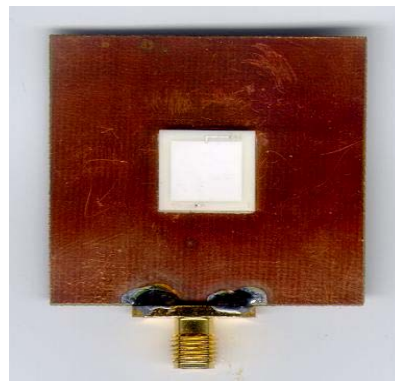

Fig. 2 Photo of the proposed antenna on test board.

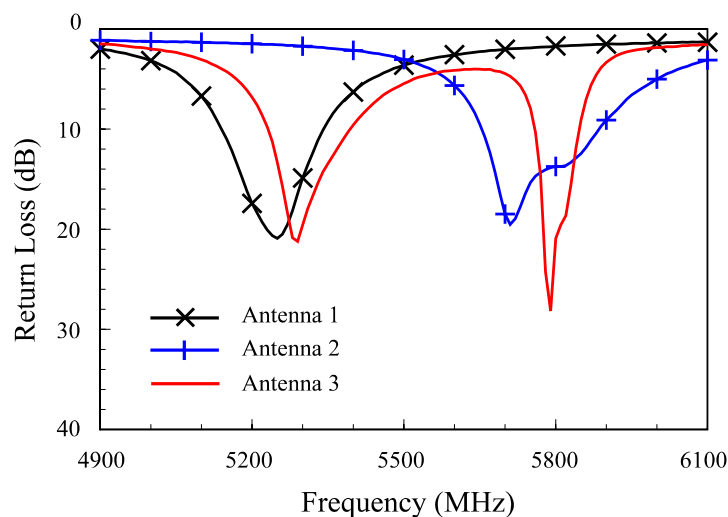
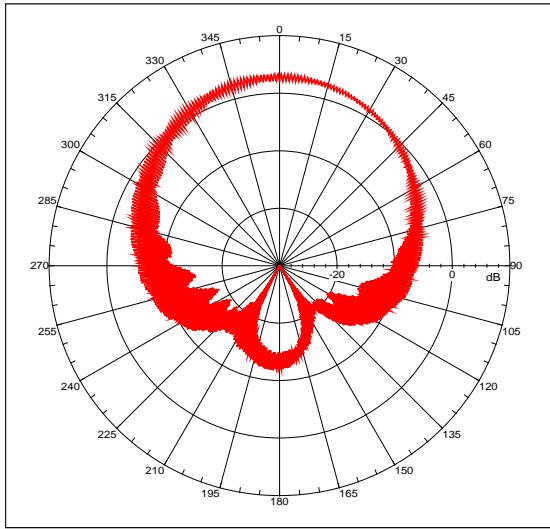
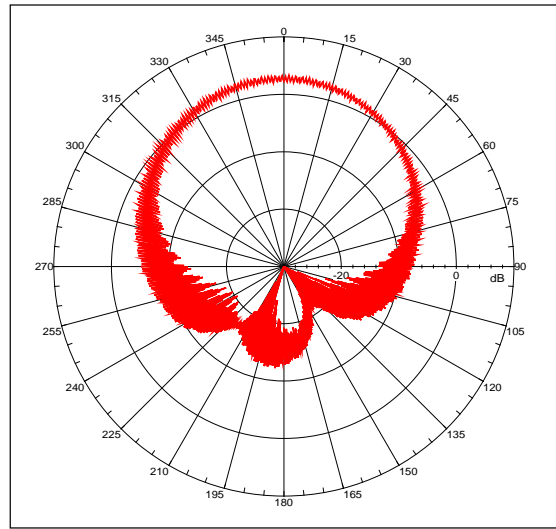

Fig. 3 Measured return loss for the proposed antenna with  $k$  (dielectric constant) = 7.8,  $h$  = 3 mil, ground-plane size = 480 mil  $\times$  480 mil; Antenna 1: with  $L$  = 366 mil,  $s$  = 44 mil,  $l$  = 80 mil,  $w$  = 12 mil,  $(x_p, y_p)$  = (-38 mil, -38 mil); Antenna 2: with  $L$  = 330 mil,  $s$  = 44 mil,  $l$  = 85 mil,  $w$  = 12 mil,  $(x_p, y_p)$  = (-35 mil, -35 mil); Antenna 3: with  $L_u$  = 360 mil,  $L_l$  = 352 mil,  $s_u$  = 44 mil,  $l_u$  = 120 mil,  $s_l$  = 20 mil,  $l_l$  = 40 mil,  $w$  = 12 mil,  $(x_p, y_p)$  = (-80 mil, -80 mil).



(a)



(b)

Fig. 4 (a) Measured radiation pattern for Antenna 1 at  $f = 5.275$  GHz;(b) Measured radiation pattern for Antenna 2 at  $f = 5.75$  GHz.

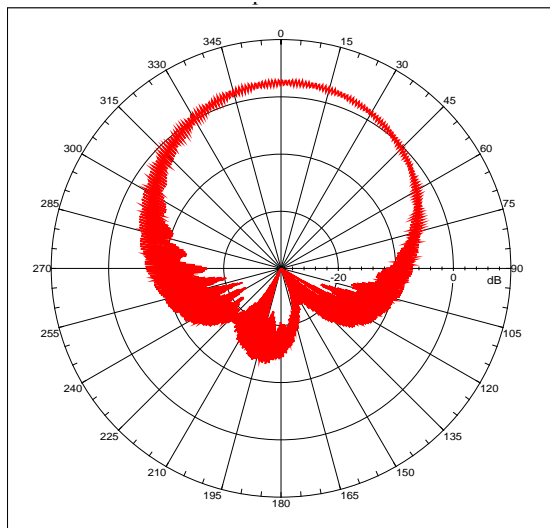

(a)

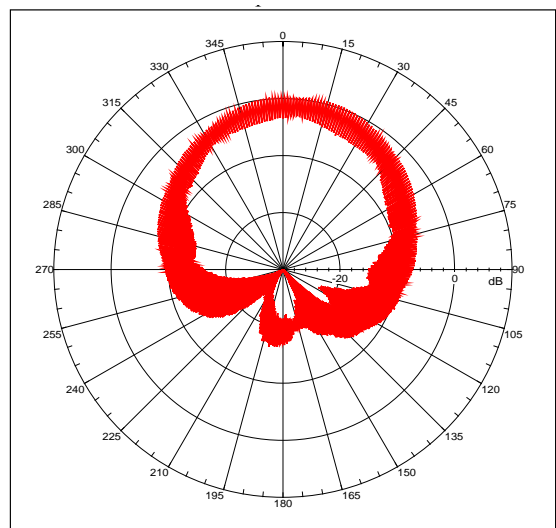

(b)

Fig. 5 Measured radiation patterns for the dual-band CP chip antenna (Antenna 3); (a) at  $f = 5.3$  GHz, (b) at  $f = 5.8$  GHz