

EFFECT OF PERTURBATION ON THE PARASITIC PATCH OF SINGLY-FED CIRCULARLY-POLARISED STACKED PATCH ANTENNAS

Kwok L. Chung
 Microwave and Wireless Technology Research Laboratory
 Faculty of Engineering,
 University of Technology, Sydney
 1 Broadway, Sydney, NSW 2007, Australia
 E-mail: klchung@ieee.org, ananda@eng.uts.edu.au

1. Introduction

It is well-known that circularly polarised (CP) waves can be generated using a singly-fed (SF) microstrip patch antenna. When a positive or negative perturbation segment (such as a strip, slot, stub or truncated segment) is added to a circular or square patch, the degenerative orthogonal waves of TM_{10} and TM_{01} mode are created simultaneously [1]-[2]. Typical shapes of singly-fed patches such as nearly square, circular with stubs, square with truncated corners are regarded as the simplest elements for exciting circular polarisation. No matter the type of SFCP patches, the amount of perturbation has to be precisely fine-tuned to obtain a low axial-ratio. The amount of perturbation is related to the total unloaded quality factor (Q_o) of the patch resonator [2] whereas the sense of CP depends on the feed location. Unfortunately, the quality factor is not an inherent physical parameter, although it substantially adheres to the physical dimensions as well as the materials which make up the resonator.

Earlier type of SFCP patch antennas were single layer, whose obtainable maximum gain, impedance and axial-ratio bandwidths were very limited. Therefore, broadband and high-gain multilayer structures that make use of stacked patches soon become popular [3]-[4]. An interesting problem arises when considering an additional patch: should the perturbation be introduced on the parasitic patch? Will the CP quality be degraded if it is not included? Design examples of parasitic patch added with perturbation are common [6]-[8]. Recently, the author presented a systematic method [5] for the design of multilayer SFCP stacked patch antennas. By using this design method, a CP stacked patch should for the first time that the perturbation on the parasitic patch is not mandated [9]. The orthogonal modes were created although one degree of freedom (one design variable) was lost. Low axial-ratio and wide bandwidths are still readily obtained. In this paper, we present a study on the effect of perturbation on the parasitic patch of SFCP stacked patch antennas. We demonstrate the relative advantages of such an effect by using two design examples: with zero and finite perturbation made on the parasitic patches of two antennas, respectively. The sequentially rotation feeding technique is an effective way to increase the bandwidths and directivity to suit the requirements of general CP applications [7]-[9]. However, the rotations of SFCP elements would be the constraint on the design of arrays using a coplanar feed network with a small element spacing [7]-[8]. A parasitic patch with zero perturbation shows a promising solution [9].

2. Parasitic Patches with zero and finite Perturbation

The SFCP stacked patch antennas under investigation are X-band designs with a desired centre frequency of 10 GHz. A common right-hand CP geometry with a 50 ohm microstrip line fed on its median line as shown in Fig. 1. The normal and inverted patches printed on a high ($\epsilon_1 = 6.15$) and a low ($\epsilon_3 = 2.2$) dielectric-constant laminate, respectively. The unequal-sized patches are separated by a middle layer of air dielectric ($\epsilon_2 = 1.0$) so that the antenna is made up of *hi-lo-lo* dielectrics combination. Its basic structure is similar to the conventional electromagnetically coupled patch (EMCP) antenna [3], so they are denoted as CP-EMCP elements [5]. The two CP-EMCP antennas with different design parameters are detailed in Table 1. Antenna 1 has a zero perturbation ($q_2 = 0.0$) on its parasitic patch with a square size of 9.4 mm whereas Antenna 2 has a finite perturbation of $q_2 =$

2.0 mm. Both antennas have the same thicknesses on their substrates and superstrates whereas the air layers have the different thicknesses as shown.

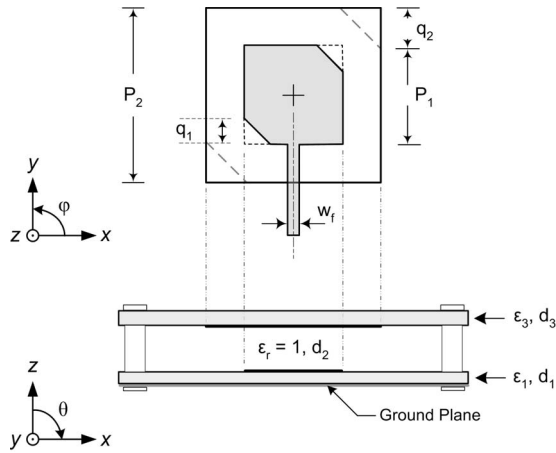

Fig. 1 The geometry of the stacked patch with CP-EMCP structure, where P_1 , P_2 , q_1 , and q_2 are the square patch length and the corresponding perturbation length of the stacked patches, respectively [5].

Table 1 Design parameters of two X-band CP-EMCP elements whose common geometry as shown in Fig. 1.

Parameter	Antenna 1	Antenna 2
P_1	6.2 mm	6.1 mm
P_2	9.4 mm	10.0 mm
q_1	1.6 mm	1.68 mm
q_2	0.0 mm	2.0 mm
ϵ_3, d_3	2.20, 0.78 mm	
d_2	3.3 mm	2.5 mm
ϵ_1, d_1	6.15, 0.64 mm	

3. Effect of Perturbation on Rotated Parasitic Patch

The performance of the two CP stacked patch antennas are shown in Figs. 3(a)-(f) in terms of return loss, CP gain and boresight axial-ratio, respectively. Antenna 2, which has one more design variable as compared to Antenna 1, achieves a wider axial-ratio bandwidth than that of Antenna 1 as shown in Figs. 3(e) and (f). Meanwhile, the results on gain and impedance bandwidth of two antennas are similar as indicated by the solid lines in Figs.3 (a) to (d). The measurement results of Antenna 1 were reported in [9] and are not repeated here. We apply an angular rotation about the z -axis to the parasitic patch of both antennas and exam the effects on the abovementioned performance. Two angular steps at 22 and 45 degrees in both clockwise (CW) and counter-clockwise (CCW) directions, as shown in Fig. 2, were used. The impedance matching characteristics, gain, boresight axial-ratio are calculated using the EM simulator Ensemble and compared to the performance with no rotation (0°) in Fig. 3. Antenna 2, which has finite perturbation on its parasitic patch, not only breaks the symmetry in the x - y plane but also depresses the coupling between stacked patches when rotation occurs. A difference in symmetry is observed from the geometry of Antenna 2 at the rotation of 45° in CW and CCW directions whilst no difference is found from Antenna 1.

The difference in perturbation on the parasitic patch between the two antennas produces a marked difference on their performance when a relative rotation occurs. The 10-dB impedance bandwidths for Antenna 1 are almost constant whilst changes on the return loss curves from Antenna 2 are recorded in Fig. 3(b). The rotation effects on the gain and axial-ratio from Antenna 1 are also trivial for all angles of rotation. However, the effect on the boresight axial-ratio of Antenna 2 is observed to be significant although the changes on gain are acceptable with rotations in both directions. Moreover, at the maximum rotation of 45° the antennas exhibit a large difference in axial-ratio bandwidth: 7.5% from Antenna 1 against 0% from Antenna 2. As mentioned in Section 1, small element spacing inside a sequentially rotated array (SRA) is hardly achieved due to the rotation of elements and the feed network. For example, SRAs presented in [7] has a large spacing of $0.85\lambda_0$ owing to the placement of feed lines for the rotated elements. With zero perturbation on the parasitic patch of CP-EMCP elements, a small element spacing of $0.67\lambda_0$ with short feed-lines can be realised as reported in [9].

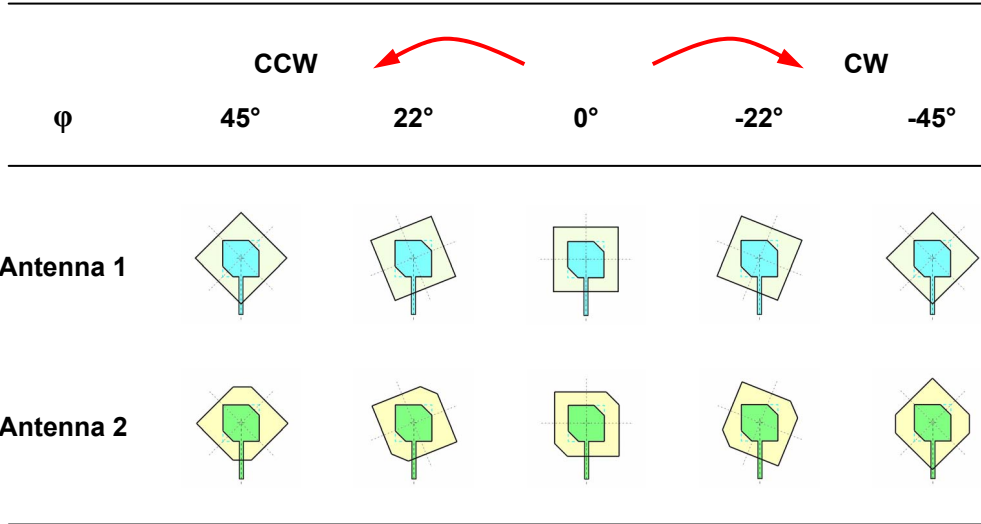
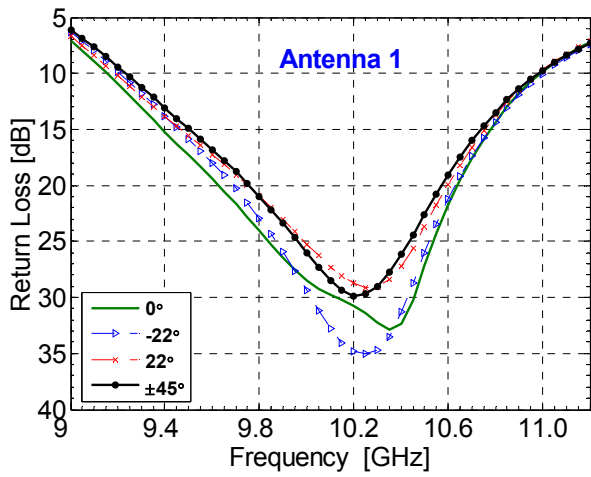
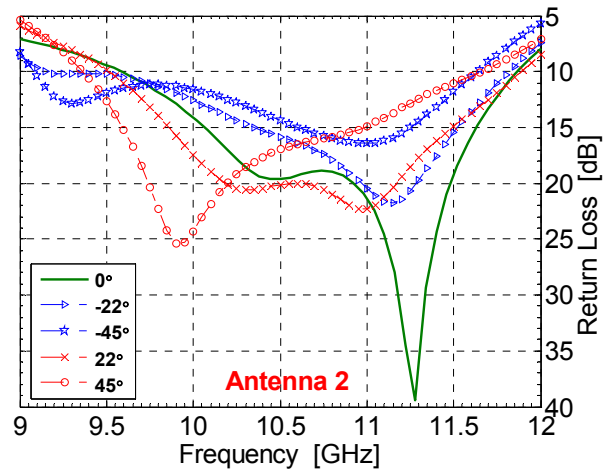

Fig. 2 Angular rotation of parasitic patches on two CP-EMCP antennas in four angles.



(a) Effect on Return loss of antenna 1.



(b) Effect on Return loss of antenna 2.

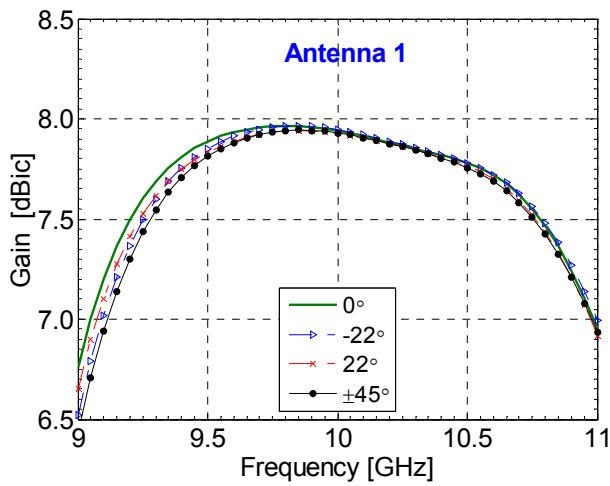

(c) Effect on Gain of antenna 1.

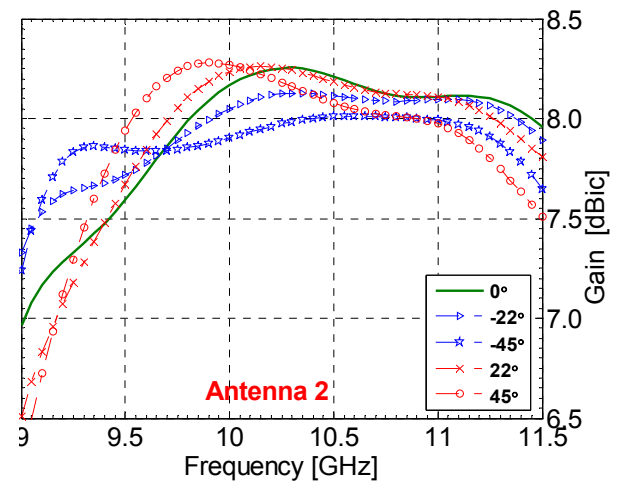

(d) Effect on Gain of antenna 2.

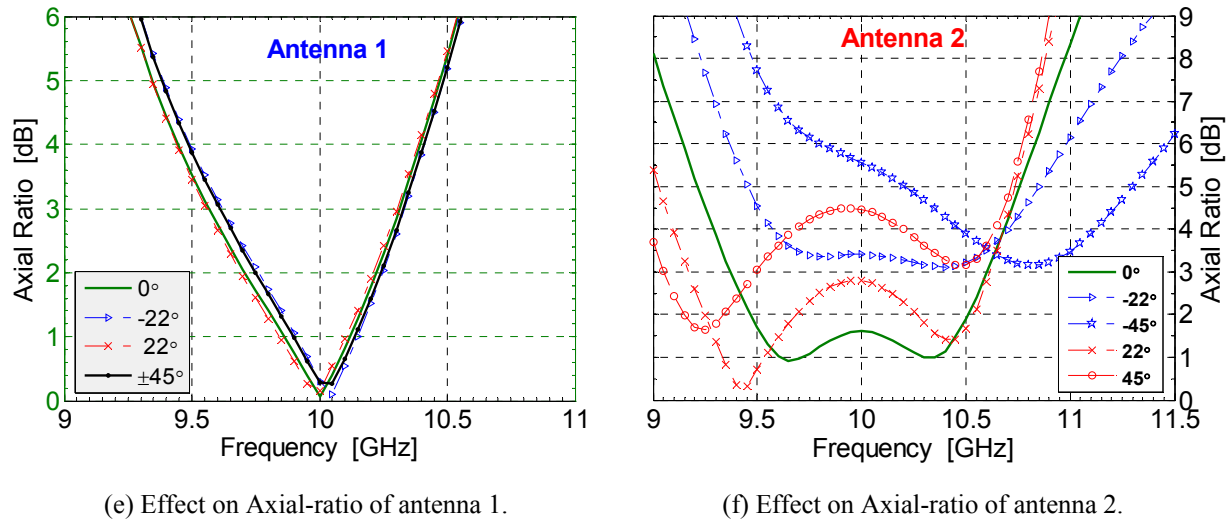

Fig. 3 The variation of (a)-(b)Return loss; (c)-(d)Gain and (e)-(f)Axial-ratio versus frequency for two CP stacked patch antennas, whose parasitic patches are rotated in four angles. CW: -22° , 45° CCW: 22° , 45° . Solid lines show the results for normal (0°) aligned parasitic patches of both antennas.

4. Conclusion

In this paper, the effects due to the angular rotations on the parasitic patches that have different perturbation amounts of two CP stacked patch antennas were investigated. The design examples indicate that the perturbation on the parasitic path of a CP stacked patch antenna may not be required in terms of antenna performance, although one degree of freedom is lost during the fine-tuning process. The performance between two antennas having different perturbations is compared. A comparison reveals the one with zero perturbation is robust in its overall performance when a relative rotation between stacked patches occurs. Such an element is a good candidate in the design of high performance sequential rotation array.

References

- [1] Y. T. Lo and W. F. Richards, "Perturbation approach to design of circularly polarised microstrip antennas", *Electron. Lett.*, vol. 17, pp. 383-385, May 1981.
- [2] M. Haneishi and S. Yoshida, "A design method of circularly polarised rectangular microstrip antenna by one-point feed", *Electronics and Communications in Japan*, vol. 64-B, pp.46-54, 1981.
- [3] C. H. Chen, A. Tulintseff and R. M. Sorbello, "Broadband two-layer microstrip antenna", *IEEE AP-S Int. Symp. Dig.*, 1984, pp. 251-254.
- [4] P. S. Hall, C. Wood and C. Garrett, "Wide bandwidth microstrip antennas for circuit integration", *Electron Lett.*, vol. 15, pp. 458-460, Jul 1979.
- [5] K. L. Chung and A. S. Mohan, "A systematic design method to obtain broadband characteristics for singly-fed electromagnetically coupled patch antennas for circular polarisation", *IEEE Trans. on Antennas and Propag.*, vol. 51, pp. 3239-3248, Dec 2003.
- [6] N. C. Karmaker and M. E. Bialkowski, "Circularly polarised aperture-coupled circular microstrip patch antennas for L-band applications", *IEEE Trans. Antennas and Propagat.*, vol. 47, pp. 933-940, May 1999.
- [7] W. Choi, C. Pyo and J. Choi, "Broadband circularly polarised corner-truncated square patch array antenna", *IEEE AP-S Int. Symp. Dig.*, 2002, vol. 2, pp. 220-223.
- [8] Y. Liu, M. Shahabadi, S. Safavi-Naeini and S. Suleiman, "Gain improvement of an array of sequentially rotated circularly polarised microstrip antennas using stacked parasitic patches", *IEEE AP-S Int. Symp. Dig.*, 2003, vol. 1, pp. 614-617.
- [9] K. L. Chung and A. S. Mohan, "A circularly polarized stacked electromagnetically coupled patch antenna", *IEEE Trans. Antennas and Propagat.*, vol. 52, pp. 1365-1370, Jun 2004.