

PARTIALLY-DIELECTRIC-FILLED OVERSIZED RECTANGULAR WAVEGUIDE  
FOR SUPPRESSION OF SIDE LOBES IN SLOT ARRAYS

Miroslav Samardzija\*, Takafumi Kai, Jiro Hirokawa, Makoto Ando  
Department of Electrical and Electronic Engineering, Tokyo Institute of Technology  
S3-19, 2-21-1, O-okayama, Meguro-ku, Tokyo, 152-8552 Japan  
E-mail: miro@antenna.ee.titech.ac.jp

### 1. Introduction

We propose a hollow-waveguide-fed parallel plate slot array antenna in which two dielectric rods are installed at the both side walls of an oversized rectangular waveguide as shown in Fig.1(a). The size of the proposed antenna is assumed to be small, around  $2 \times 2 - 3 \times 3 \lambda$ . The specific purpose is to achieve a uniform field distribution and a low side lobe level of radiation pattern. The slot pairs in the antenna are arrayed in spacing of one guided wavelength to be excited in phase.

Conventionally, the guided wavelength in an oversized rectangular waveguide is reduced by filling the whole region with dielectric material to suppress the grating lobes in longitudinal direction [1], [2]. In the proposed structure, the guided wavelength is controlled and reduced by changing the width of the two dielectric rods installed at the side walls of the oversized rectangular waveguide. Since the oversized rectangular waveguide is only partially filled with dielectric material, the power loss due to the dielectric will be noticeably less than that of the overall-filled waveguide [2].

In this paper, we estimate the reduction of the guided wavelength of the lowest mode and the field distribution in the oversized rectangular waveguide due to the installation of the dielectric rods. Based upon these phenomena, we calculate and investigate array factors of  $4 \times 4$  array for various widths of the dielectric rods to suppress the side lobes in both  $E$  and  $H$  plane.

### 2. Configuration and Analysis

Fig.1(a) shows the configuration of the proposed waveguide-fed oversized rectangular slot array antenna. The radiating units are slot pairs etched on the top plate. In the radiating unit, two slots are spaced approximately by a quarter of a guide wavelength to cancel the reflections from the two slots. Two dielectric rods are installed at the both narrow walls of the radiating waveguide. A feed waveguide is placed on the same layer as the radiating waveguide and arranged as a cascade of several coupling windows.

An analysis model for a partially-dielectric-filled oversized rectangular waveguide is shown in Fig.1(b). The air region is in the middle of the rectangular waveguide and is the region of interest. In partially filled waveguide, the hybrid modes that are the solution and satisfy the boundary conditions are transverse electric  $TE^x$  and transverse magnetic  $TM^x$ , for which  $E_x=0$  and  $H_x=0$ , respectively [3]. In this paper, we deal with only  $TE^x$  modes uniform along  $y$ -direction in a thin oversized rectangular waveguide. For the symmetry in the  $x=0$  plane, a perfect magnetic conducting (PMC) wall in the  $x=0$  plane assumes only propagating modes that are odd and symmetric. A transcendental equation is derived by enforcing the condition of continuous admittance along the interface surface, i.e. along  $x=d$  plane. Solving the transcendental equation numerically the propagation constant ( $2\pi/\lambda_g$ ) is obtained as function of the width of the air region and the width of dielectric rods.

### 3. Design for suppression of grating lobes

The spacing of the radiating units should be set to less than the free space wavelength ( $\lambda_0$ ) to suppress the side lobes in the longitudinal direction. The width of a partially-dielectric-filled waveguide is set to  $2.8\lambda_0$ , which provides space for four radiating units in  $x$ -direction, spaced at the distance of  $0.7\lambda_0$ . In  $z$ -direction, the guided wavelength is originally reduced due to the coupling of non-resonant slots with an incident field [1]. The radiating units are arranged with  $0.84\lambda_0$  spacing by

taking in to account the average phase delay of  $60$  degrees due to the slot coupling. Considering this slow wave effect, the reduction of the guided wavelength by the dielectric rods is utilized actively to get the desired grating lobe suppression. On the other hand, the increase of the width of dielectric rods causes the inner field degradation in transverse direction and thereby increases the level of side lobes in  $x$ -direction. As a preliminary step, we calculate an array factor of the radiating units both in transverse and longitudinal direction for various widths of the dielectric rod. We evaluate the grating lobe variation caused by both guided wavelength reduction effect and the degradation of the field distribution in  $x$ -direction. The optimal width of the dielectric rods is determined to minimize the grating lobe.

#### 4. Results

In partially–dielectric-filled oversized rectangular waveguide, the number of propagating modes increases with the total width of the waveguide as shown in Fig.2. In the waveguide of  $2.8\lambda_0$  air-region width and  $0.23\lambda_0$  dielectric width there are three propagating modes. Only the lowest mode is discussed throughout this paper.

The guided wavelength as a function of the width of dielectric rods for various widths of the air region is presented in Fig.3. The dielectric material is PTFE (*Teflon*) and the dielectric constant is  $2.17$ . The operating frequency is  $12\text{GHz}$ . The width of dielectric rods is independent of the air region width for guided wavelengths shorter than free space wavelength. It is of interest to note that for certain width of dielectric rods ( $0.23\lambda_0$ ) the guided wavelength becomes equal to the free space wavelength ( $\lambda_0$ ). For the width of dielectric rods above  $0.23\lambda_0$  the guided wavelength ( $\lambda_g$ ) becomes shorter than the free space wavelength ( $\lambda_0$ ). In Figure 4, the width of the dielectric rods is given as a function of the air-region width for a desired guided wavelength. It converges to a certain value for increase of the air-region width.

The magnitude of the electric field component in the  $y$ -direction ( $E_y$ ) throughout the cross section of the air region is shown in Fig.5. When the guided wavelength is equal to the free space wavelength the magnitude of  $E_y$  becomes uniform across the air region independent of the air-region width. In case of the guided wavelength shorter than that of free space, the  $E_y$  in the waveguide becomes a cosine-hyperbolic function depending on the propagating constant. The difference in the magnitude of the  $E_y$  in the centre of the waveguide and at the air-dielectric interface increases exponentially as the guided wavelength decreases. This is taken in account when considering the radiation pattern in  $x$ -direction.

An array factor of a  $4$  by  $4$  array is calculated in  $z$ - and  $x$ - directions and shown in Fig.6. The array factor in the  $z$ -direction shows the grating lobe suppression as the guided wavelength decreases, i.e. the width of dielectric rods increases above  $0.23\lambda_0$ , as is expected. The radiation pattern in Fig.6(b) is calculated by allocating the field distribution in  $x$ -direction to each radiating unit. In addition, the side lobe level in the  $x$ -direction increases from  $-25\text{dB}$  to  $-7\text{dB}$  at  $\pm 45\text{deg}$ . as the guided wavelength decreases from  $1.0\lambda_0$  to  $0.97\lambda_0$ . A proper guided wavelength in a  $2.8\lambda_0$  air-region wide partially–dielectric-filled waveguide for which the highest grating lobe suppression of  $-9.0\text{dB}$  is  $0.978\lambda_0$  with respect to lowest side lobe level in  $x$ -direction as shown in Fig.7.

#### 5. Discussion

In the present analysis model of the partially–dielectric-filled oversized waveguide, only the lowest mode with cosine-hyperbolic field distribution is considered. As shown in Fig.2, number of propagating modes increases with the increase of the width of partially-filled waveguide. Propagating modes of higher order have cosinusoidal distributions while the lowest mode cosine-hyperbolic distribution, in  $x$ -direction. The uniformity of the inner field in  $x$ -direction would be improved by summing up the lowest mode and a few higher modes with proper ratio by the feed waveguide.

The degradation of the inner field of the lowest mode in the waveguide generates higher side lobes in the  $x$ -direction due to the non-uniform excitation of the radiation units in transverse direction. The feed waveguide structure with coupling windows is to be included and designed to excite the desired excitation into the oversized radiating waveguide region in the analysis model.

## 6. Conclusion

A partially-dielectric-filled rectangular waveguide has been proposed to suppress the side lobes in the small-size waveguide fed parallel plate slot array. The transcendental equation has been derived and thereby the guided wavelength as a function of the geometry of the partially-filled rectangular waveguide. For a partially-dielectric-filled waveguide of a size  $2.8 \times 2.8\lambda_0$  with slot array of 4 by 4 radiating units, a proper guided wavelength, i.e. width of the dielectric rods is given with respect to maximal grating lobe suppression of  $-9.0\text{dB}$  in longitudinal direction and minimal side lobe level of the worst case, in transverse direction in Fig.7.

## References

- [1] J.Hirokawa, M.Ando and N.Goto, "Waveguide-Fed Parallel Plate Slot Array Antenna," IEEE Trans. Antennas & Propagat., vol.40, no.2, pp.218-223, Feb. 1992.
- [2] J.Hirokawa and M.Ando, "Single-Layer Feed Waveguide Consisting of Posts for Plane TEM Wave Excitation in Parallel Plates," IEEE Trans. Antennas & Propagat., vol.46, no.5, pp.625-630, May 1998.
- [3] C.A. Balanis, Advanced Engineering Electromagnetics, New York: Wiley, 1989.

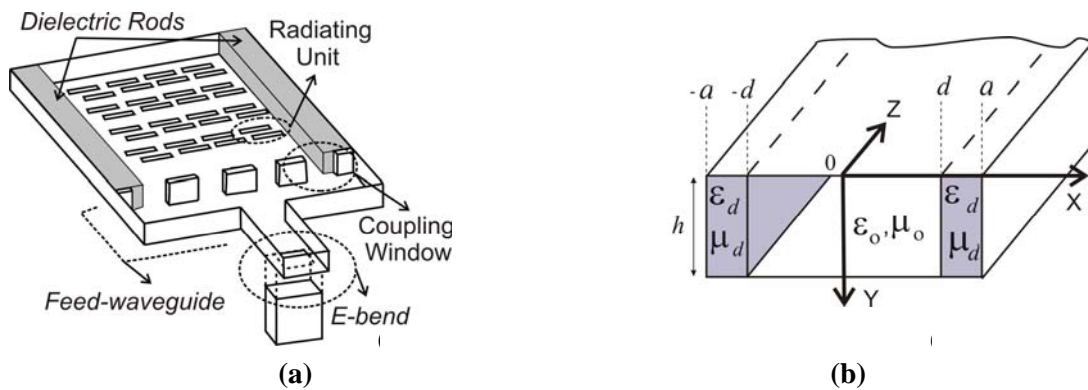

**Figure 1:** (a) Antenna outline, (b) Analysis model of a partially dielectric filled rectangular waveguide.

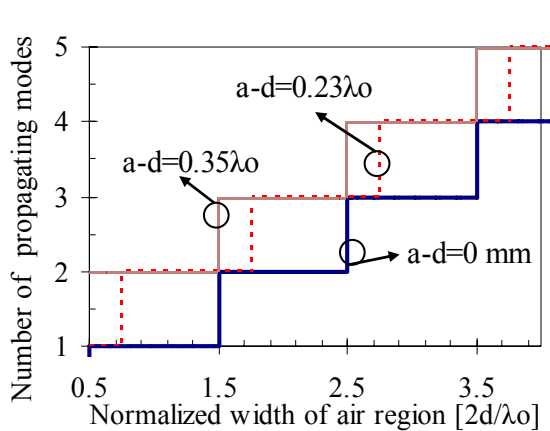

**Figure 2:** Number of propagating modes as a function of the air region width for various widths of dielectric rods.

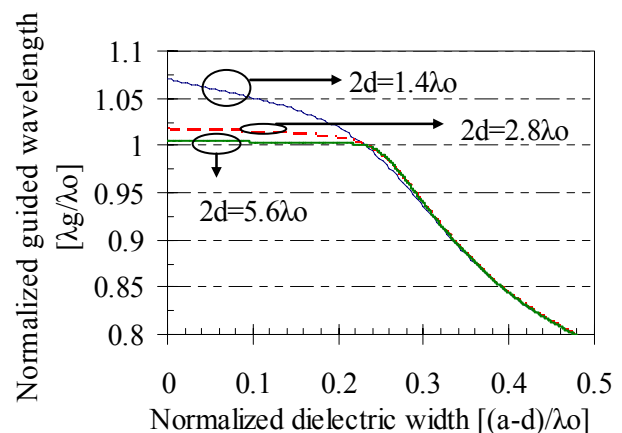

**Figure 3:** Guided wavelength as a function of dielectric width for various air region widths.

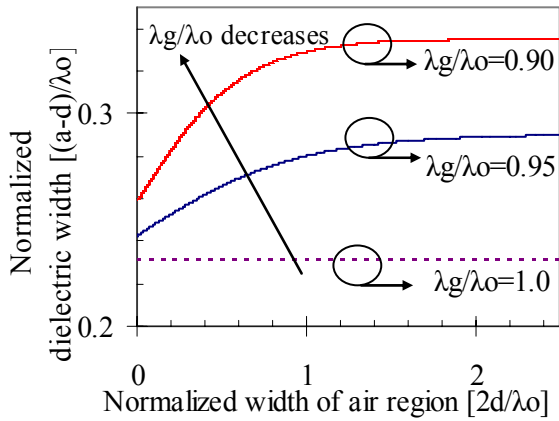

**Figure 4:** Design geometry for the partially filled rectangular waveguide at the desired guided wavelength.

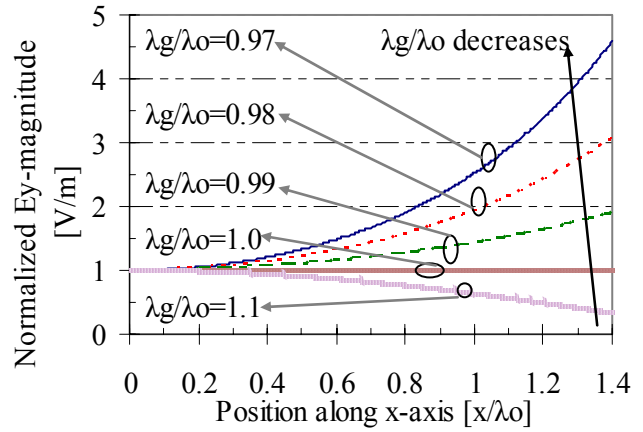

**Figure 5:** Field distribution throughout the cross section of the air region in the waveguide.

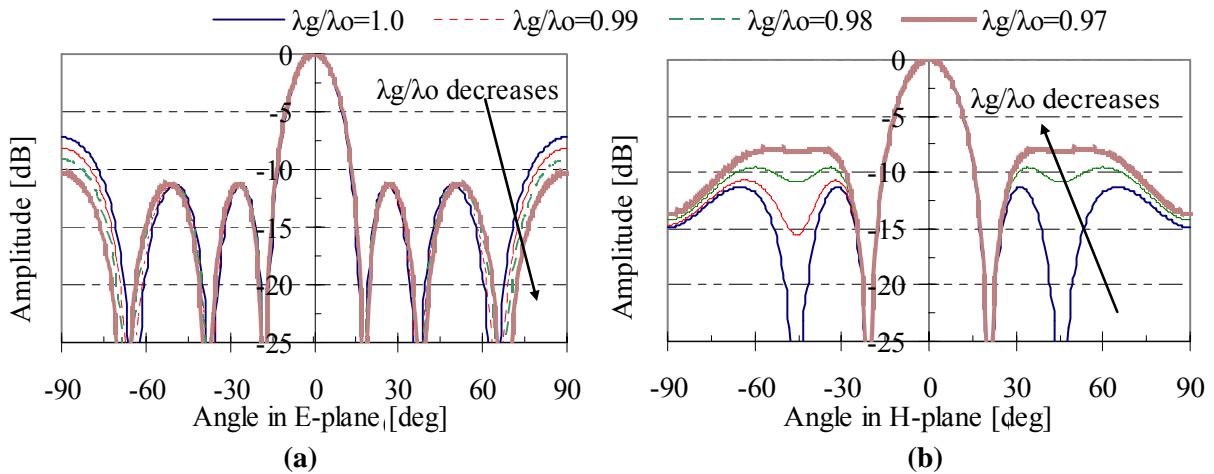

**Figure 6:** Radiation pattern of the array factor for 4 radiating units at various desired guided wavelengths a) in the z-direction b) in the x-direction.

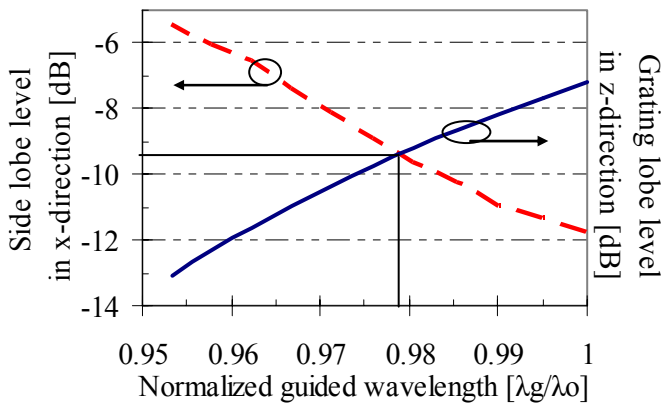

**Figure 7:** Optimal guided wavelength of  $0.978\lambda_0$  (dielectric width of  $0.26\lambda_0$ ) for the waveguide of  $2.8\lambda_0$  air-region width and the  $4 \times 4$  radiating-unit array. Side lobe level is the worst case scenario due to the analysis of the lowest mode only.