

Experimental Verification of Multipactor Breakdown for Space RF Hardware

Seung-woon Choi¹, Day-young Kim¹, Jong-in Lee¹, Hak-jung Kim¹ and Pil-yong Lee²
¹Dept. of Satellite Electronics, KOMPSAT Program Office, Korea Aerospace Research Institute (KARI),
 45, Eoeun-Dong, Yuseong-Gu, Daejeon, 305-333, Republic of Korea, antelch@kari.re.kr
²M&MLYNX R&D center, M&MLYNX, Inc.,
 302-1, Sangha-Dong, Kiheung-Gu, Yongin-Si, Kyoungki-Do, Republic of Korea, pylee@mmlynx.com

Abstract

An experimental verification of multipactor(MP) breakdown for S-band duplexer as a sample DUT for space application by an in-house MP test facility is proposed. The designed duplexer having two BPFs for Rx and Tx is applied to a design of five pole inter-digital cavity type band pass filter with chebyshev response, it has 2.7 % bandwidth centred at 2.232 and 2.055 GHz for Rx, Tx, respectively. To avoid the MP breakdown, the accurate design and analysis methods based on 3D EM field analysis are considered. The proposed in-house MP test facility consists of a phase detecting system using a doubly balanced mixer in addition to a phase nulling system, RF power measurement, electron current detector and so forth. The calculated MP threshold RF input power is 43.13 dBm. The measured MP breakdown power is 43 dBm and 44 dBm for CW mode and pulsed mode test, respectively. The designed S-band duplexer for MP breakdown is worthily verified by the in-house developed MP test facility.

1. INTRODUCTION

The RF hardware in space born communications should be taken into account with extreme space environments such as high/low temperature, vacuum, and thermal stress. The RF components such as a duplexer especially handled high RF power under high vacuum condition can make the multipactor(MP) discharge phenomena [1]. MP is a resonant multiplication of secondary electrons which can occur when a free electron caught in input RF fields that impact to a surface wall with sufficient energies to release more than one secondary electron at a phase, and the RF field can finally accelerate these secondary electrons. As a consequence, it can affect RF performance degradation such as increasing of spike noise, return loss and noise level in pass band as well as damaging of physical structure of the surface [1], [2].

In this review, the description of designed duplexer mainly deals with only focused on Tx BPF part of the duplexer rather than that of Rx because the former is located in front of a transmitter with high RF power and the latter is only receiving path with exactly same configuration except for operating frequency. And a commercial full wave finite-element method(FEM) is used to design and optimize the

electrical performance of the proposed duplexer and analyze the MP breakdown phenomena after the initial design.

2. DUPLEXER DESIGN

The designed structure is a conventional type of duplexer as a sample DUT(Device Under Test) and consists of two band pass filters and the proposed topology has a 5 pole chebyshev response with inter-digital cavity type made by silver plated aluminium as shown in Fig. 1. Each resonator is a quarter-wavelength long at mid-band and is short circuited at one end and open-circuited at the other one for each centre frequency. The initial design is performed from well-known filter design technique calculated by [3], [4].

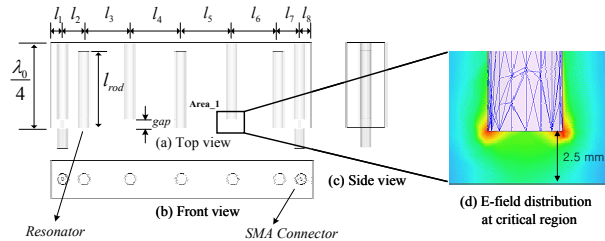

Fig. 1: Simulation model of Tx BPF in a part of duplexer and the identification of maximum E-field accumulated region with 2.5 mm gap

The duplexer however should be a MP free structure operated in space handled with high RF power, so more detail design analysis are needed such as following. In order to get the MP free structure up to 20 watt RF input power, the duplexer was designed without any performance degradation as following; the first is the length of resonator was more 3.68 mm shorter than the initial quarter-wave length value (33.63 mm) to increase the gap spacing up to more than 2.5 mm, the second is the diameter of rods (5 mm) was more bigger to get the same fringing capacitance C_f and the last is the duplexer was designed as the cavity length is about 1.32 mm larger than that of initial value. Based on well-known filter synthesis technique [3], [4] and some design modifications as above, the external quality factor Q_{ext} is found to be 37.1 and the lengths of $l_1(=l_8)$, $l_2(=l_7)$, $l_3(=l_6)$, $l_4(=l_5)$ and l_{rod} , l_{gap} are 5 mm, 9.75 mm, 19.57 mm, 20.73 mm and 29.95 mm, 2.5 mm, respectively.

3. MULTIFACTOR ANALYSIS

In order to calculate the MP threshold RF power for above designed duplexer, the multipactor susceptibility curve is adapted from [1] and the threshold gap voltage ($V_{th}(h_i, \omega)$) is about 496.7 voltage with 5.58 GHz×mm of F×d product. The worst gap field voltage inside of the structure is calculated by integral of E-field through the critical gap distance, 2.5 mm using (1) and (2).

$$E(t) = \text{Re} \left(\sum_i E(f_i) e^{j(2\pi f_i t + \phi_i)} \right) \quad (1)$$

$$V_{gap} = \max_{x \in (0, \omega)} \int E_y(x, y, z = z_i; \omega) \cdot dy \quad (2)$$

Next to evaluate the power handling capability of the device, the VMF (Voltage Magnification Factor) is employed [5], [6] and the handling power without MP discharge is calculated from (3), (4) and frequency responses are shown in Fig. 2 and Table 1. The below table shows the maximum RF power without MP breakdown as 20.57 watt (43.13 dBm) at 4th pole of Tx filter.

$$VMF(z_i, \omega) = \frac{V_{gap}}{V_{in}} \quad (3)$$

$$P_{i, \max}(\omega) = \frac{V_{th}^2(h_i, \omega)}{2Z_0(\omega)(V_{gap}/V_{in})^2(z_i, \omega)} \quad (4)$$

TABLE 1: GAP VOLTAGE AND MP THRESHOLD POWER AT EACH RESONATOR

	Gap volt [V]	VMF	MP Threshold power	
			Watt	dBm
1st pole	54.62	7.72	41.35	46.16
2nd pole	74.48	10.53	22.24	43.47
3rd pole	71.97	10.18	23.81	43.77
4th pole	77.44	10.95	20.57	43.13
5th pole	56.17	7.94	39.10	45.92

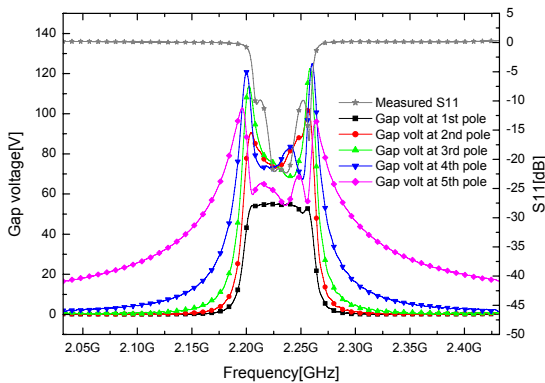

Fig. 2: Simulated E-field voltage between each resonator end and wall surface with operating frequencies

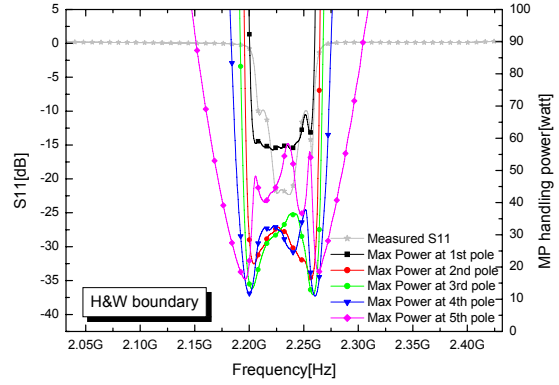

Fig. 3: Simulated MP free RF handling input power between each resonator end and wall surface with operating frequencies

4. EXPERIMENTAL RESULT

A. In-house developed MP test facility and test conditions

The fabricated duplexer with silver plated aluminium body is shown in a sub-figure of right side in Fig. 5 with dimension of 240×47.78×15 mm and functionally tested as insertion loss is less than 0.65 dB and VSWR is less than 1.22 at ambient condition.

MP test should be performed under the high vacuum condition with reasonable free electron clouds as making in-orbit situation. So, the electron seeding which can be simulated by electron gun is necessary for MP test. Though there are a number of test methods, MP test is mainly divided by two categories as CW or pulsed mode test and also exist different test concepts as single carrier or multi-carrier approach. And the test methods are also categorized with two cases; one is global detection method, the other is local detection method [1], [5].

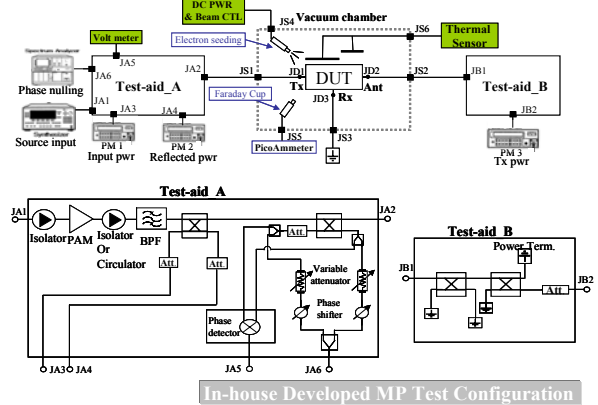

Fig. 4: In-house developed MP test facility

MP test condition is following; the vacuum level of less than 10^{-5} torr, dwell time of 5 minutes and 3 minutes for CW, pulsed respectively, incremental RF power step of 0.5 dB with electron seeding and the test is performed by both CW

and pulse mode test of single carrier with additional aging test under 1dB below RF power level of that of MP detected with more than 2hrs duration in order to verify the our MP test methodology.

the in-house developed MP test method is hybrid method which is capable of both global detection methods as a phase imbalance DC voltage detecting system with doubly balanced mixer(DBM) by DC voltmeter Agilent 34401A, RF power measurement by power meter Agilent E4418B and phase nulling spectrum monitoring by spectrum analyzer Agilent E4440B and local detection methods as electron current detection with faraday cup by pico-ampere meter Keithly6485. The test configuration is shown in Fig. 4 and vacuum chamber(VC) interface and the electron gun, faraday cup and duplexer(DUT) in side of VC are shown in Fig. 5. The test acquisition and test control are performed by LabView, national instrument through GPIB interface for a real time measurement.

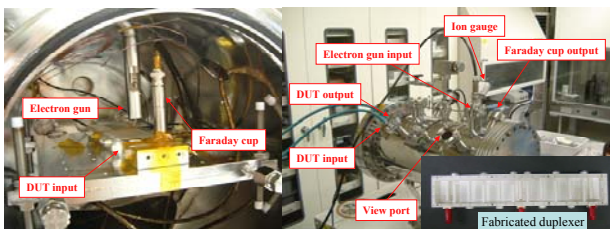

Fig. 5: Vacuum chamber (VC) configuration and fabricated duplexer (Left: Setup of inside of VC), (Right: VC interfaces with test facility and fabricated S-band duplexer without top cover)

B. CW(Continuous Wave) mode test

CW mode is tested with Fig. 4 configuration and major test results are shown in Fig. 6 and Fig. 7 under high vacuum condition. The main test methods are DC output voltage, electron current and phase nulling spectrum monitoring. The first is detected by the voltage output difference measurement of mixed signals' phase and amplitude between input and reflected RF signal, the second method is measured by an amount of radiated secondary electrons' current level synchronized with RF field using an electron collector named faraday cup and the last method is to monitor the nulling spectrum of input and reflected RF signals as shown in Fig. 4.

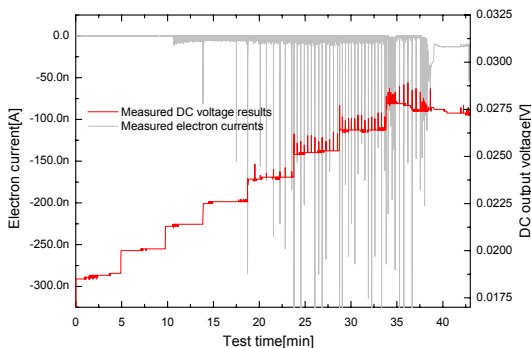

Fig. 6: The measured DC output voltage and electron current of CW mode

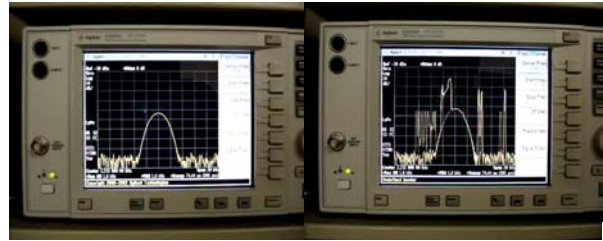

Fig. 7: Nulling spectrum of CW mode at 43dBm RF input power (Left: No MP, 42.5 dBm input), (Right: MP detected, 43 dBm input)

From about 20 minute in Fig. 6, the electron current and DC output voltage show the burst-like noise that increase continuously the test time up to 33 minute and at around 35 minute the DC output voltage detected by DBM is decreased slowly and electron current is also increased with some period about 36 minute. At that time the RF input power is 43 dBm and the nulling spectrum show the spike noise in the spectrum as shown in Fig. 7 that clearly give the MP breakdown phenomena compared with MP and without MP detected.

C. Pulsed mode test

Pulsed mode test is performed with PRF(pulse repetition frequency) of 1KHz, duty cycle of 3 % with same configuration of that of CW mode test. The test results for pulsed mode are also shown in Fig. 8 and Fig. 9 with almost same symptoms except for MP detecting RF input power level of 44 dBm.

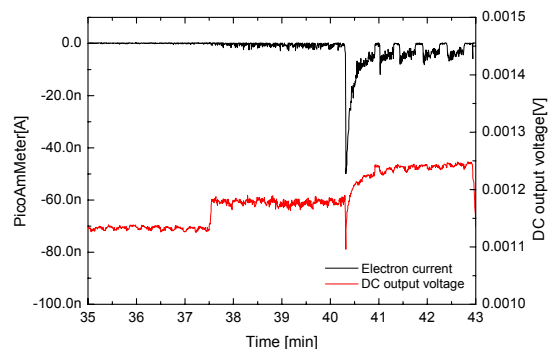

Fig. 8: The measured DC output voltage and electron current of pulsed mode

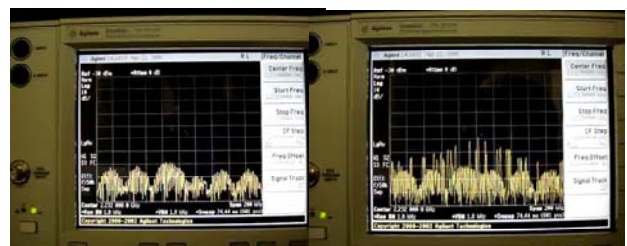

Fig. 9: Nulling spectrum of pulsed mode at 43dBm RF input power (Left: No MP, 43.5 dBm input), (Right: MP detected, 44 dBm input)

D. Aging test

To verify the operating of the duplexer, the additional aging test is performed at CW mode which is much worse than pulsed mode in terms of MP breakdown. The aging test time is more than 2 hours and testing RF power is just 1dB below than that of CW mode MP detected. The test results are shown in Fig. 10 to Fig. 11 and no abnormality is detected.

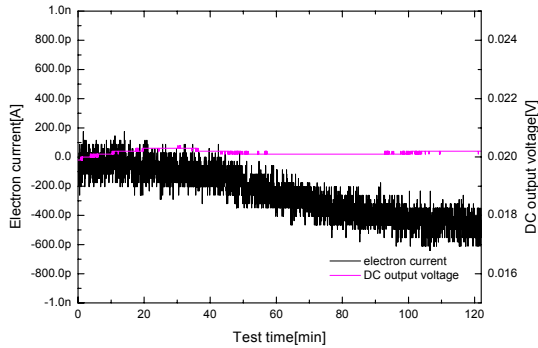

Fig. 10: Aging test results of electron current and DC output voltage

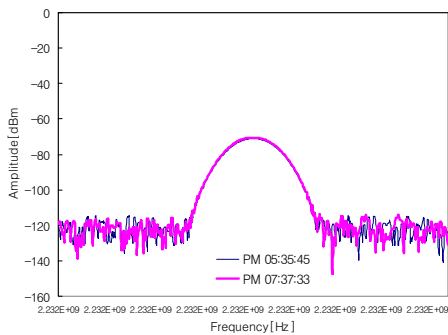

Fig. 11: Aging test result of phase nulling spectrum

E. MP test summaries

The results of the CW and pulsed mode test show the MP sensitivity RF input power level as the 43 dBm and 44 dBm respectively with 0.5 dB incremental step and that give only 1 dB difference of MP detected power. The reasons are that the CW signals generate more heat dissipation at MP occurring spot point even though the temperature control for base plate is conducted for all testing time compared with pulsed mode test and the probability of the electrons' ejection from the wall of duplexer which can easily make the trapped electron by the sufficient RF input power is much more than that of pulsed mode. The discrete 0.5 dB step was moreover applied to the MP test so that the ambiguity also exists with ± 0.25 dB. And to confirm the MP test method developed in-house, the additional aging test is performed with no abnormality detected.

As above statements no more than 1 dB difference is reasonable one and the in-house developed MP test method is well constituted and verified.

The DC voltage detection system is low cost and simple configuration as a global method. It can easily predict the MP initial starting time similar with an electron current detecting system which is high cost and have more complex setup for testing rather than that of the nulling spectrum system as a well-known global detecting system that is very difficult to estimate the beginning time of MP breakdown.

5. CONCLUSION

The S-band duplexer as a sample DUT is designed and fabricated with electrical good performances. Multipactor breakdown for the duplexer is calculated and experimentally verified by using of the in-house developed MP test facility. The proposed in-house MP test facility consists of a phase detecting system using a doubly balanced mixer in addition to a phase nulling system, RF power measurement, electron current detector and so forth. The calculated MP threshold power is 43.13 dBm and the measured MP breakdown power is 43 dBm and 44 dBm for CW mode and pulsed mode test, respectively. The designed S-band duplexer for MP breakdown is worthily verified by our test facility. The developed MP test method is powerful for applying of one port device such as antenna as well as more than 2 port devices and is low cost, simple structure and gives a good agreement.

ACKNOWLEDGEMENT

The authors acknowledge support of this work by MOCIE (Ministry of Commerce, Industry and Energy) and MOST (Ministry of Science and Technology) Rep. of Korea.

REFERENCES

- [1] A. J. Hatch and H. B. Williams, "Multipacting Modes of High Frequency Gaseous Breakdown," *The Physical Review*, vol. 112, No 3, pp. 681-685, November 1958.
- [2] A. Woode and J. Petit, "Diagnostic Investigations into the multipactor effect, susceptibility zone measurements and parameters affecting a discharge," *ESA Working paper* No. 1556, Noordwijk, The Netherlands, Nov. 1989.
- [3] G. L. Matthaei, L. Young, and E. M. T. Jones, *Microwave Filters, Impedance-Matching Networks, and Coupling Structures*. Norwood, MA: Artech, 1980.
- [4] Edward G. Cristal, "Coupled Circular Cylindrical Rods Between Parallel Ground Planes," *IEEE MTT*, pp.428-439, July. 1964.
- [5] ESA publication division, *Space engineering, Multipaction Design and Test, ECSS-E-20-01A*. ESA-ESTEC, May. 2003.
- [6] M. Ludovico, G. Zarba, L. Accatino, and D. Raboso, "Multipaction analysis and power handling evaluation in waveguide components for satellite antenna applications," *IEEE AP-S International Symposium and USNC / URSI National Radio Science Meeting*, 2001.