

Design of Novel Slot UHF Near-Field Antenna for RFID Applications

Qichao Yang¹, Jingping Liu¹, Safieddin Safavi-Naeini²

¹School of Electronic and Optical Engineering, Nanjing University of Science and Technology
Nanjing 210094, Jiangsu, China

²Electrical and Computer Engineering, University of Waterloo
N2L 3G1, ON, Canada

Abstract—A novel slot near-field antenna is proposed for UHF (ultrahigh frequency) RFID (radio frequency identification) applications in this paper. The antenna overcomes the limitations in large dimension and weakness of environmental impact of slot antenna. The antenna prototype is printed onto a piece of FR4 substrate, with an overall size of $108\text{mm} \times 72\text{mm} \times 0.8\text{mm}$ while the slot area dimension is $54\text{mm} \times 40\text{mm}$. This antenna can achieve strong and uniform magnetic field in column interrogation zone with the radius of 30cm and height of 60cm, and it has good read efficiency in a wide frequency band of 900MHz-950MHz.

Index Terms: near-field, slot antenna, UHF (ultrahigh frequency), RFID (radio frequency identification)

I. INTRODUCTION

RFID (radio frequency identification) is a kind of automatic identification technology that uses RF (radio frequency) signal with the space coupling mode to achieve non-contact transmission of information and information processing, so as to recognize the objects. Due to its various superiorities such as high reading speed, large storage space, the capability of wireless working, adaptability in multiple environment, the RFID technology receives a lot of attention. It is currently in a stage of rapid evolution. More and more industries put emphasis on its applications research^[1]. Technologies such as Internet of Things, radio frequency identification, near-field communication technology will be several key technologies in the future which can change people's daily life and make our life more convenient.

The paper proposes the design of the antennas those are smaller, better performance in metallic environment than other near-field antennas. Perhaps in the majority opinions, the stronger and bigger coverage of the field of the antenna should be the better, while a small range of reading is not functional. In fact, some applications situation just like engineering manufacture requires a wider range of reading the tag data. Imagine the scene in family or the shelf in library, there are many household appliances can be used on RFID technology to make our lives more comfortable. The affection each other in a small range area will be especially prominent. The near-field technology can be a good solution, to this problem. Interrogator zone of near-field antenna can be limited in a

particular region with a very uniform and strong electromagnetic field without dead area, avoid the mutual interference between the respective antennas, and ensure the effective reliability of the region.

Generally, there are three methods to achieve near-field antenna:

- 1、Use antenna cavity.
- 2、Reduce the transmit power.
- 3、Segmented structure.^[2]

In this paper we construct a kind of antenna with uniform magnetic field and with the second method to achieve near-field antenna. Compared to other near-field antennas, this antenna has the advantages such as novel structure, small size, uniform magnetic field and fabrication easily, the most important thing is that it can work well in metallic environment while other near-field antennas can hardly work closing to metal.

II. ANTENNA STRUCTURE ANALYSIS

Slot antenna has an uniform magnetic field, but its dimension is large. What we must do is to optimize its structure.

According to Babinet Theorem: the dipole and slot antenna is the complementary structure so we can predict the gap length and the input impedance of the slot antenna corresponding to the dipole with the same resonant frequency.^[3] As shown in Fig. 1.

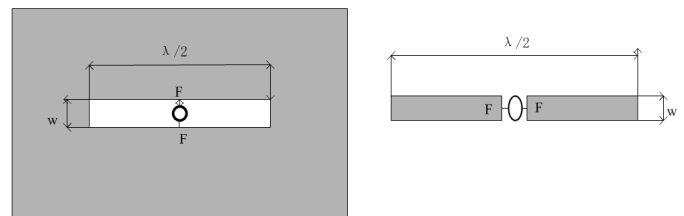

Figure 1. Slot antenna and complementary dipole

According to the formula: $\lambda = c/f$, the size of a half wavelength slot antenna is about 163.9mm. For RFID applications such as mobile payment, bio-sensing, it is not a suitable size. So we thought of bending the gap to increase current path while reduce antenna dimension. as shown in the following diagram Fig. 2.

Compared to other methods, such a bending structure can achieve some advantages. We can see the differences in the following diagram Fig. 3.

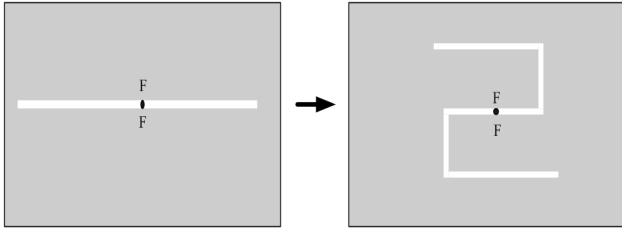

Figure 2. Gap structural changes

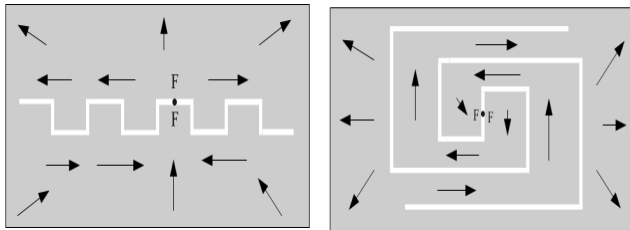

Figure 3. Current distribution of two slot antennas

Since the current is not strictly in accordance with the gap direction, but to flow on the plane messily. The left diagram shows that the current is still disorder in the entire plane, which result in no increasing in current path. However, the right diagram is an efficient bending structure because the entire conductor piece is divided into several areas by the gap masterly. The current direction is roughly along the gap, so as to effectively increase the current path. The disadvantages of this structure is to produce parasitic resonant frequency, but also affect the radiation efficiency of the antenna. So appropriate gap spacing and gap width is necessary.

Furthermore, if we can reduce the size of the gap portion of the antenna plane, the benefits of doing so is that the antenna can work well in case of closing to meal. As shown in diagram Fig. 4 below:

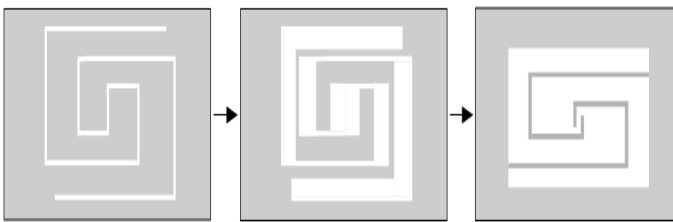

Figure 4. Gap width increases gradually

Imagine that, the gap width is gradually increased while the conductor width is gradually reduced, until a limiting case shown in the third diagram in Fig. 4. The current flows along the conductor strip the flows to the large conductor plane. This structure can be regarded as the variation of slot antenna, also

can be seen as the variation of the folded dipole because they are complementary antenna. This antenna reduces the portion of slot which decides the resonant frequency. It can achieve a strong and uniform magnetic field even when works close to metal.

III. ANTENNA STRUCTURE

The two antennas are printed on an FR4 (relative dielectric constant of 4.4, and loss tangent of 0.02) printed circuit board (PCB), thickness is 0.8 millimeter. The two proposed antenna are shown in Fig. 5 and Fig. 6. Detailed parameters of these two antennas are shown in diagrams.

Dimensions of the PCB of the two antennas are the same, $108 \times 72 \times 0.8 \text{ mm}^3$, while the slot portions are different. They are $100 \times 46 \text{ mm}^2$ and $54 \times 40 \text{ mm}^2$ respectively. We can select different size of the antenna depending on different applications.

IV. RESULT AND TEST

The slot antenna 1 and 2 is shown in Fig. 7, The S11 simulation diagram and S11 tested with real antenna by Vector Network Analyzer are shown in Fig 8, they match very well. The resonant frequency is 919MHz and the -10dB bandwidth is from 910MHz to 930MHz. This antenna has a column interrogation zone with the radius of 30cm and the height of 70cm.

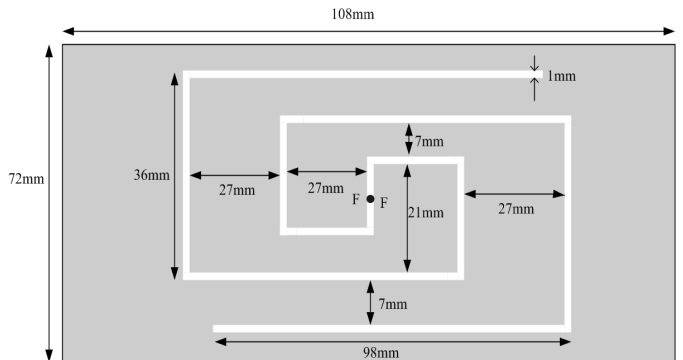

Figure 5. Configuration of slot antenna 1

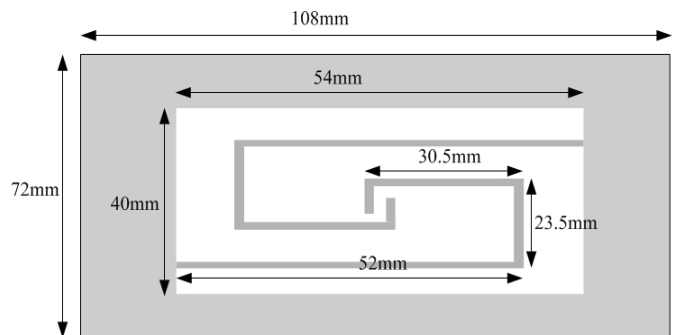

Figure 6. Configuration of slot antenna 2

The slot antenna 2 is shown in Fig. 7, The S11 simulation diagram and S11 tested with real antenna by Vector Network Analyzer are shown in Fig. 9, they match well. The resonant frequency is 928MHz and -10dB bandwidth is from 900MHz to 950MHz. This antenna has a column interrogation zone with the radius of 30cm and the height of 60cm.

The figures below shows the reader and the RFID tags test environment(30cm above the reader antenna) of the slot antenna , it has a good performance in the UHF band.

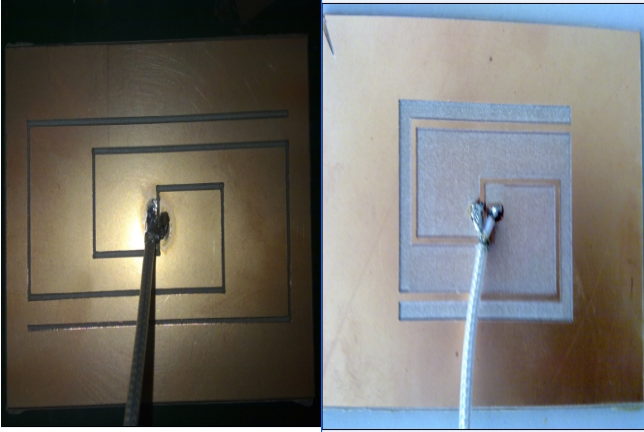

Figure 7.slot antenna 1 and 2

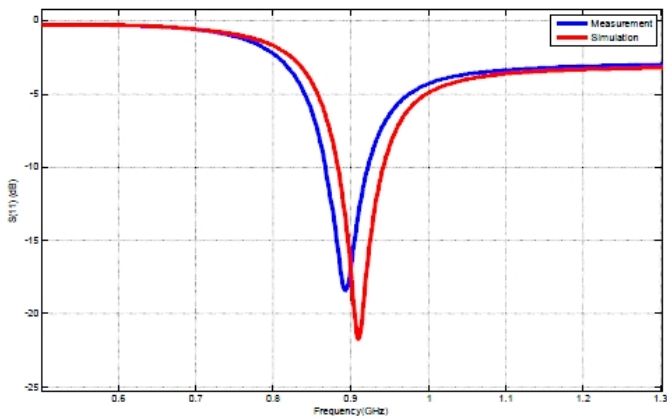

Figure 8.S11 of slot antenna 1

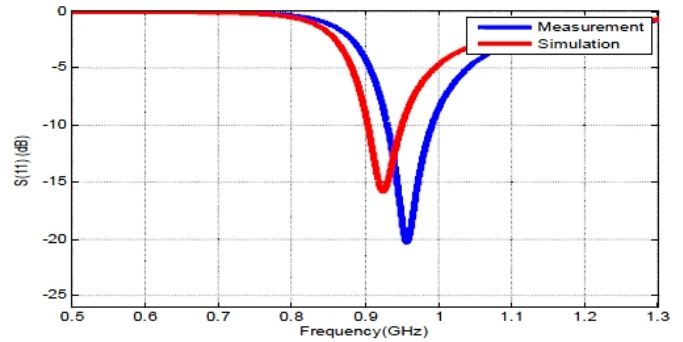

Figure 9.S11 of slot antenna 2

V. CONCLUSION

We design a novel slot RFID antenna, it has the characteristics of near-field, uniform magnetic field and small size. The gradually increased width of the slot lead to the smaller dimension, I think it gives antenna engineers some inspirations in reducing the antenna size. And it is also the biggest innovation in this paper.

REFERENCES

- [1] Xianming Qing; Zhi Ning Chen; , "UHF near-field RFID antennas," *Antenna Technology (iWAT), 2010 International Workshop on* , vol., no., pp.1-4, 1-3 March 2010
- [2] Xianming Qing; Chean Khan Goh; Zhi Ning Chen; , "A Broadband UHF Near-Field RFID Antenna," *Antennas and Propagation, IEEE Transactions on* , vol.58, no.12, pp.3829-3838, Dec. 2010
- [3] Xing, Z.; Wang, L.; Wu, C.; Wei, K.; , "Study of broadband near-field antenna for ultra-highfrequency radio frequency identification applications," *Microwaves, Antennas & Propagation, IET* , vol.5, no.14, pp.1661-1669, November 18 2011
- [4] Chihyun Cho; Chuyong Lee; Jeongki Ryoo; Hosung Choo; , "Planar Near-Field RFID Reader Antenna for Item-Level Tagging," *Antennas and Wireless Propagation Letters, IEEE* , vol.10, no., pp.1100-1103, 2011
- [5] Jin Shi; Xianming Qing; Zhi Ning Chen; , "A cavity backed UHF near-field segmented loop antenna," *Antennas and Propagation (APCAP), 2012 IEEE Asia-Pacific Conference on* , vol., no., pp.25-26, 27-29 Aug. 2012