

Planar Circularly Polarized Antenna with Broadband Operation for UHF RFID System

Jui-Han Lu¹, Hai-Ming Chin² and Sang-Fei Wang¹
¹Department of Electronic Communication Engineering
²Department of Marine Engineering
National Kaohsiung Marine University
Kaohsiung, Taiwan 811

Abstract- Novel circular polarization (CP) design of planar broadband antenna with square slot for UHF RFID system is proposed and experimentally studied. By inseting the arc-shaped strip into the square slot, the proposed CP design can easily be achieved with the impedance bandwidth (RL \square 10 dB) of about 142 MHz (15.3% @ 931 MHz) and the 3 dB axial-ratio (AR) bandwidth of about 166 MHz (17.7 % @ 940 MHz) for UHF RFID applications. The measured peak gain and radiation efficiency are about 6.8 dBic and 98% across the operating band, respectively, with nearly bidirectional pattern in the XZ- and YZ-plane.

I. INTRODUCTION

UHF (860–960 MHz) band radio-frequency identification (RFID) system becomes more attractive for many industrial services such as supply chain, tracking, inventory management and bioengineering applications because it can provide longer reading distance, fast reading speed and large information storage capability. The RFID reader antenna is one of the important components in RFID system and has been designed with CP operation. The detection range and accuracy are directly dependent on the performance of reader / tag antennas. Since the RFID tags are always arbitrarily oriented in practical usage and the tag antennas are normally linearly polarized, circularly polarized (CP) antennas become the most popular candidates to receive the RF signal that emanates from arbitrarily oriented tag antennas for improving the reliability of communications between readers and tags. Moreover, circularly polarized antennas can reduce the loss caused by the multi-path effects between the reader and the tag antenna. However, the UHF frequencies authorized for RFID applications are varied in different countries and regions. Hence, a universal reader antenna with desired performance across the entire UHF RFID band operated at 860–960 MHz (a fractional bandwidth of 11.1%) would be beneficial for the RFID system configuration and implementation to overcome the operating frequency shift and impedance variations due to the manufacturing process errors. Circular polarization can be obtained by exciting the two orthogonal linearly polarized modes with a 90° phase offset. Numerous CP reader antennas for UHF RFID system have been presented such as the aperture-coupled annular ring patch antenna with thick high-dielectric substrate [1], a sequentially fed stacked corner-truncated CP patch antenna [2], the stacked patch antenna composed of two corner-truncated patches with a horizontally meandered strip [3], a circularly polarized patch antenna excited by an open circular ring microstrip line through multiple slots [4],

asymmetric-circular shaped slotted microstrip antenna [5]. Although, the above mentioned reader antennas are focused on the unidirectional radiation pattern, they have disadvantage of bulky volume [1, 3–4] or complex structure [2]. The reader antenna with bidirectional radiation can be introduced in the entry-way scanning system to minimize the number of needed reader antennas with unidirectional radiation, which definitely reduces the implemented cost. Two RFID reader antennas have also been presented such as the square-ring antenna fed by a Wilkinson power divider [6] and the annular-ring slot antenna with a slotline feed [7]. The former design is with less antenna gain while the latter design is with narrower 3-dB AR bandwidth which can't meet the overall bandwidth specification of global RFID system. Under the condition of the same antenna size, using a printed slot antenna is a certain method, which is due to the fact that printed slot antennas usually have a wider impedance bandwidth than the microstrip patch antennas [8–10], can be the effective way to improve the operating bandwidth. Several slot antennas with CP operation have been presented such as the slot antenna with the truncated corner and a grounded inverted-L strip at the two opposite corners [11], with a T-shaped stub and a microstrip T-junction [12], with multi parallel slots [13], a pair of orthogonally positioned radiating slots with a three-stub hybrid coupler as the feeding network [14], a stair-shaped slot antenna with a longitudinal slot etching at the middle part [15] and a number of CP slot antennas fed by an L-shaped strip [16–23]. However, wide slot antennas with CP design for UHF RFID system are very scant in the open literature. Therefore, in this article, we present a novel CP design of planar broadband UHF RFID reader antenna with bi-directional reading pattern. This RFID reader antenna is composed of the square slot antenna with the inseting grounded arc-shaped strip and fed by the F-shaped microstrip line to obtain the broadband CP operation. Due to the grounded arc-shaped strip to disturb the surface electric field distribution on the square slot, two near-degenerated resonant modes (TE₁₀ and TE₀₁ modes) with 90 degrees phase difference can be closely excited to form a wider CP operating bandwidth for UHF band. The obtained impedance bandwidth across the operating band can reach about 142 MHz (15.3 % centered at 931 MHz) and the 3 dB axial-ratio (AR) bandwidth of about 166 MHz (17.7 % centered at 940 MHz). With bi-directional reading pattern, the maximum antenna peak gain and radiation efficiency across the operating band are about 6.8 dBic and 98 %, respectively, which is more than that of the presented

square-ring antenna [6]. Noted that a square metallic reflector can be arranged below the slot antenna to provide a unidirectional broadside patterns and reduce the backlobe radiation; its physical position is about one-quarter wavelength below the slots [15]. Details of the proposed UHF RFID reader antenna design is described and its experimental results from the obtained CP performance as operating at 900 MHz band are presented and discussed as well. A parametric study for the major parameters of the proposed CP antenna is also conducted.

Table 1 : The optimal dimensions of the proposed broadband circularly polarized antenna with square slot.

Parameter	Value (mm)	Parameter	Value (mm)
L	126	W	121
L1	27.5	W1	15
L2	38	W2	6.2
L3	38	W4	1.48
L4	20	R1	71
G	0	R2	66

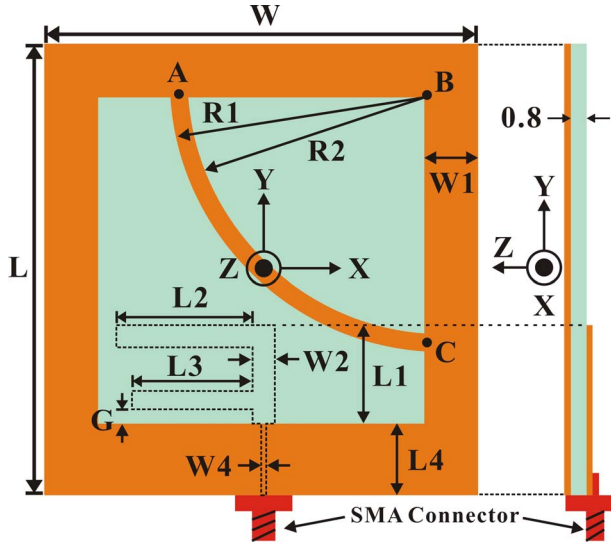

Figure 1. Geometry and photograph of the proposed planar broadband circularly polarized antenna with square slot for UHF RFID Reader.

II. ANTENNA DESIGN

The geometry and photograph of the proposed broadband circularly polarized antenna with square slot is shown in Fig. 1. The circularly polarized antenna with the total antenna size of $126 \times 121 \text{ mm}^2$ is printed on an FR4 substrate ($\epsilon_r = 4.4$, thickness = 0.8 mm, loss tangent = 0.0245). The optimal dimensions of this proposed broadband circularly polarized antenna with square slot are listed in Table 1. This radiating square slot is set to be the dimension of $91 \times 91 \text{ mm}^2$ as to degenerate TE_{10} and TE_{01} components of CP. We obtain the operating frequency 915 MHz calculated by (1) and they are roughly the same as the frequency with the lowest axial ratio centered at 940 MHz in Fig. 2.

$$f_c = \frac{c}{2\pi\sqrt{\epsilon_{eff}}} \times \sqrt{\left(\frac{m\pi}{a}\right)^2 + \left(\frac{n\pi}{b}\right)^2} \quad (1)$$

In (1), c is $3 \times 10^8 \text{ m/s}$ and ϵ_{eff} is the effective permittivity of the FR4 substrate. Note that (1) is approximate formulas to predict the operating frequencies of two CP modes for this designed slot antenna and they would have obvious errors when the width ($W1$) of the ring ground plane is too narrow. An F-shaped strip is etched on the bottom-layer of the substrate and fed through a matching 50Ω microstrip feed line which has a width ($W4$) of 1.48 mm and length ($L4$) of 20 mm. The vertical strip ($L1$) that succeeds the microstrip feed line is of 27.5 mm long. The first horizontal strip has a length ($L2$) of 38 mm and a 4.3 mm gap is made at the strip end and the ring ground plane as to provide capacitive effects. In addition, the second horizontal strip is placed above the ring ground plane with the gap (G) and has the length ($L3$) of 38 mm as the tuning stub to adjust the input impedance of this proposed CP antenna, which is different from the design using high characteristic impedance of the feeding microstrip line [17-18, 19-23]. The resonant length ($L1 + L2$) of the bent strip is 65.5 mm in corresponding to approximately 0.21 wavelength of the resonant mode at 940 MHz. The vertical and horizontal portions of the F-shaped strip have the same width ($W2$) of 6.2 mm. The vertical portion of the F-shaped strip is parallel to y -axis (side 1) contributing to TE_{10} mode while the other side (parallel to x -axis, side 2) contributing to TE_{01} mode. The current phase on side 2 lags behind that of side 1, which causes 90 degrees out of phases between E_x and E_y at the aperture.

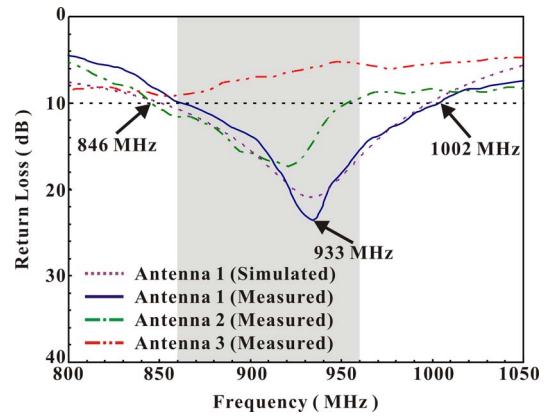
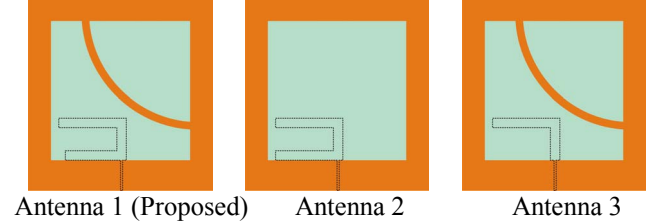

(a)

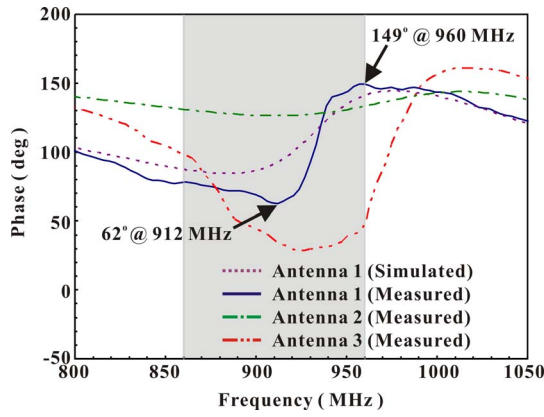

(b)

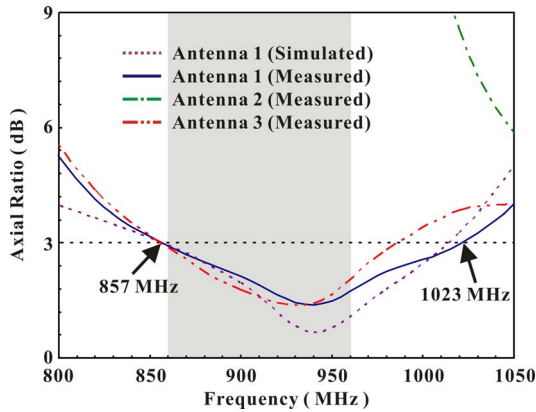

(c)

Figure 2. Simulated and measured results against frequency for the proposed planar broadband circularly polarized antenna with the grounded arc-shaped strip or not. (a) Return Loss. (b) Phase diagram. (c) Axial Ratio.

III. RESULTS AND DISCUSSION

The proposed CP antenna is designed to operate at the centre frequency of about 940 MHz in the UHF band for RFID readers. The return loss is measured using an Agilent N5230A vector network analyzer. Fig. 2 shows the related simulated and experimental results of the return loss, phase diagram and axial ratio (in the boresight direction) for the proposed CP antenna of Fig. 1 fed by F-shaped or L-shaped microstrip line. The related results are listed in Table 2 as comparison. From the related results, the measured operating bandwidth (RL \leq 10 dB) can reach about 142 MHz (860–1002 MHz) or 15.3 % centered at 931 MHz, which covers the entire UHF RFID band, and agrees well with the HFSS simulated results. Fig. 2(b) shows the simulated and measured phase diagram for the proposed CP antenna. It can be seen that these two orthogonal modes (912 MHz and 960 MHz) are excited, in 90° phase difference, resulting in good CP radiation. In Fig 2(c), this broadband CP antenna also provides a 3-dB AR over the UHF band of 857–1023 MHz or 17.7 % centered at 940 MHz. Meanwhile, it is found that the 3dB AR bandwidth of the square slot antenna fed by L-shaped microstrip line (Antenna 3) can cover the entire UHF RFID bandwidth of 860-960 MHz, however, with poor impedance matching. The CP radiation pattern measured at 940 MHz is plotted in Fig. 3, and good symmetry of bidirectional radiation has

been observed. Results show the coherent agreement between the measured and simulated results. Since a CP slot antenna radiates a bidirectional wave, the radiation patterns on both sides of the proposed CP antenna are almost the same, in which a contrary circular polarization is produced; the front-side radiates LHCP while the back-side radiates RHCP. By verification, this antenna structure has successfully achieved a cross polarization discrimination of 20 dB on a wide azimuth range, which is more than the related slot antennas fed by the L-shaped probe [16-23].

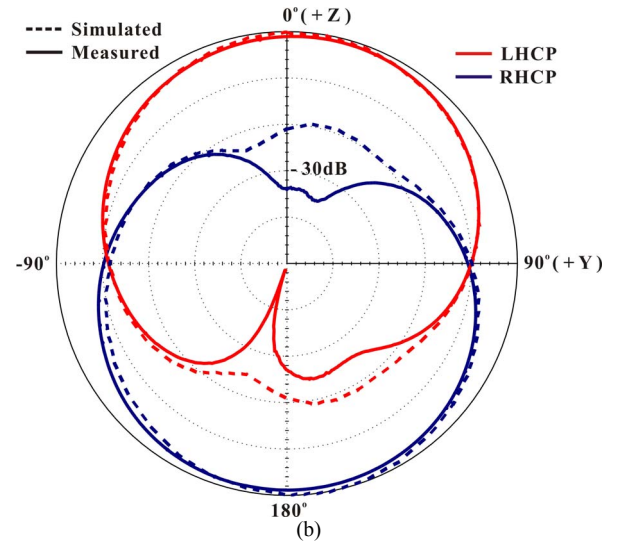
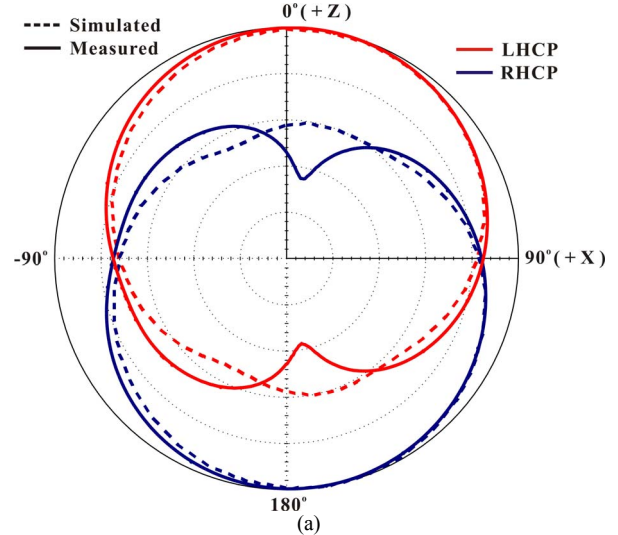

Figure 3. Simulated and measured normalized LHCP / RHCP radiation patterns for the proposed broadband CP antenna at 940 MHz. (a) X-Z plane. (b) Y-Z plane.

Plus, the radiation patterns also show that the 3-dB AR beamwidths are about 83 degrees, with symmetry in both the XZ and YZ planes. The related measured result against the operating frequency is shown in Fig. 4. It is found that the variation of the 3-dB AR beamwidth is less than 3 degrees across the overall UHF operating band. Then, a standard tag with Higgs™- 3 UHF RFID IC (ALN-9640) [27] for EPC Class1 Gen2 operating at 900 MHz is introduced for the measurement system. A commercial UHF RFID reader with the output power of EIRP 3.28 W

connected to the LP antenna with peak gain of 8.5 dBi and the dimension of $200 \times 190 \times 40 \text{ mm}^3$ as the reference antenna. In Fig. 4, the comparison of the detection ranges between the proposed CP antenna and the reference reader antenna can be observed to realize the performance sensitivity. It is easily found that the maximum reading distance for the proposed CP antenna is about 5.5 m and nearly the same as that of the reference reader antenna. Meanwhile, this proposed CP antenna has smaller volume than that of the reference antenna. Moreover, miniaturization is an important issue as we consider dexterity. Because of its low profile, the proposed CP antenna can provide compact operation with broadband operation.

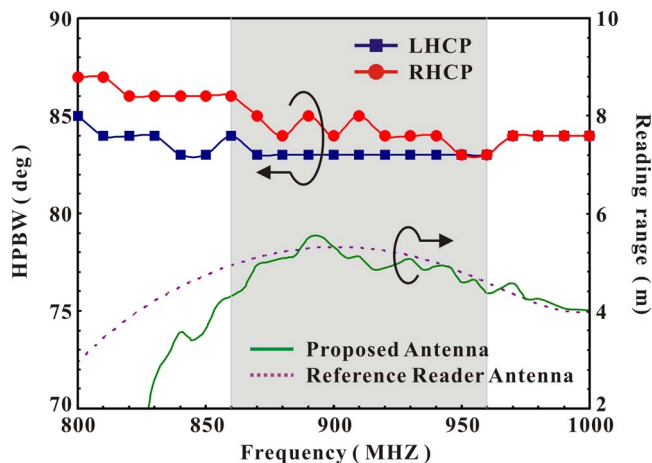

Figure 4. Measured 3-dB beamwidth and reading range across the operating frequencies for the proposed broadband CP antenna.

IV. CONCLUSIONS

A novel broadband circularly polarized antenna with square slot is proposed for the application of UHF RFID system. The obtained impedance bandwidth across the operating band can reach about 142 MHz (15.3 % @ 931 MHz) and the 3 dB axial-ratio bandwidth of about 166 MHz (17.7 % @ 940 MHz), which can cover the entire UHF RFID band. The measured peak gain and radiation efficiency are about 6.8 dBi and 98% across the operating band, respectively, with nearly bidirectional pattern in the XZ- and YZ-plane.

REFERENCES

- [1] D. H. Lee, P. J. Park, J. P. Kim and J. H. Choi, "Aperture coupled UHF RFID reader antenna for a handheld application", *Micro. Opt. Technol. Lett.*, vol. 50, pp. 1261-1263, May 2008.
- [2] Z. N. Chen, X. Qing and H. L. Chung, "A universal UHF RFID reader antenna", *IEEE Trans. Microwave Theory and Techniques*, vol. 57, pp. 1275-1282, May 2009.
- [3] Z. Wang, S. Fang, S. Fu and S. Jia, "Single-fed broadband circularly polarized stacked patch antenna with horizontally meandered strip for universal UHF RFID applications", *IEEE Trans. Microwave Theory and Techniques*, vol. 59, pp. 1066-1073, April 2011.
- [4] T. N. Chang and J. M. Lin, "A novel circularly polarized patch antenna with a serial multislot type of loading", *IEEE Trans. Antennas Propag.*, vol. 55, pp. 3345-3348, Nov. 2007.
- [5] Z. N. Chen and X. Qing, "Asymmetric-circular shaped slotted microstrip antennas for circular polarization and RFID applications", *IEEE Trans. Antennas Propag.*, vol. 58, pp. 3821-3828, Dec. 2010.
- [6] Y. F. Lin, H. M. Chen, F. H. Chu and S. C. Pan, "Bidirectional radiated circularly polarized square-ring antenna for portable RFID reader", *Electron. Lett.*, vol. 44, pp. 1383-1384, Nov. 2008.

- [7] S. A. Yeh, Y. F. Lin, H. M. Chen and J. S. Chen, "Slotline-fed circularly polarized annular-ring slot antenna for RFID reader," *2009 Asia Pacific Microwave Conference*, pp. 618-621.
- [8] H. D. Chen, "Broadband CPW-fed square slot antennas with a widened tuning stub", *IEEE Trans. Antennas Propag.*, vol. 51, no. 8, pp. 1982-1986, Aug. 2003.
- [9] A. U. Bhohe, C. L. Holloway, M. Picket-May, and R. Hall, "Coplanar waveguide fed wideband slot antenna", *Electron. Lett.*, vol. 36, pp. 1340-1342, Aug. 2000.
- [10] J. Y. Sze, and K. L. Wong, "Bandwidth Enhancement of a Microstrip-Line-Fed Printed Wide-Slot Antenna", *IEEE Trans. Antennas Propag.*, vol. 49, no. 7, pp. 1020-1024, July 2001.
- [11] Y. Shen, C. L. Law and Z. Shen, "A CPW-fed circularly polarized antenna for lower ultra-wideband applications" *Micro. Opt. Technol. Lett.*, vol. 50, pp. 2365-2369, Oct. 2009.
- [12] R. P. Xu, X. D. Huang and C. H. Cheng, "Broadband circularly polarized wide-slot antenna" *Micro. Opt. Technol. Lett.*, vol. 49, pp. 1005-1007, May 2007.
- [13] H. A. Ghali and T. A. Moselhy "Broad-band and circularly polarized space-filling-based slot antennas," *IEEE Trans. microwave theory and techniques*, vol. 53, no. 6, pp. 1946-1950, 2005.
- [14] X. Qing, Z. N. Chen and H. L. Chung, "Ultra-wideband circularly polarized wide-slot antenna fed by threestub hybrid coupler," *2007 IEEE International Conference on Ultra-Wideband*, pp. 487-490.
- [15] C. J. Wang and C. H. Chen, "CPW-fed stair-shaped slot antennas with circular polarization," *IEEE Trans. Antennas Propag.*, vol. 57, no. 8, pp. 2483-2486, 2009.
- [16] T. Fukusako and L. Shafai, "Circularly polarized broadband antenna with L-shaped probe and wide slot", *2006 ANTEM/UJRSI*, pp. 445-448.
- [17] S. S. Yang, A. A. Kishk and K. F. Lee, "Wideband circularly polarized antenna with L-shaped slot", *IEEE Trans. Antennas Propag.*, vol. 56, no. 6, pp. 1780-1783, June 2008.
- [18] J. S. Row and S. W. Wu, "Circularly-Polarized Wide Slot Antenna Loaded With a Parasitic Patch," *IEEE Trans. Antennas Propag.*, vol. 56, no. 9, pp. 2826-2832, 2008.
- [19] J. Pourahmadazar, C. Ghobadi, J. Nourinia, N. Felegari and H. Shirzad, "Broadband CPW-fed circularly polarized square slot antenna with inverted-l strips for UWB applications," *IEEE Antenna and Wireless Propagation Letters*, vol. 10, pp. 369-372, 2011.
- [20] Y. Muramoto and T. Fukusako, "Circularly polarized broadband antenna with L-shaped probe and L-shaped wide-slot", *2007 Asia-Pacific Microwave Conference*, pp. 1-4.
- [21] T. Fukusako, R. Sakami and K. Iwata, "Broadband circularly polarized planar antenna using partially covered circular wide-slot and L-probe", *2008 Asia-Pacific Microwave Conference*, pp. 1-4.
- [22] R. Joseph and T. Fukusako, "Broadband circularly polarized antenna with circular slot and separated L-probes", *2010 IEEE AP-S Int. Symp.*, pp. 1-4.
- [23] T. Fukusako and R. Joseph, "Design of broadband circularly polarized aperture antennas using L-shaped bent probe", *2011 IEEE-APS Topical Conference on Antennas and Propagation in Wireless Communications*, pp. 343-346
- [24] Ansoft Corporation HFSS, <http://www.ansoft.com/products/hf/hfss>.
- [25] IEEE Standard Test Procedures for Antennas: ANSI/IEEE-STD149-1979, Sec. 12-13, pp. 94-112.
- [26] B. Y. Toh, R. Cahill and V. F. Fusco, "Understanding and measuring circular polarization", *IEEE Trans Edu.*, vol. 46, pp. 313-318, Aug. 2003.
- [27] Alien Technology Corporation, <http://www.alientechnology.com/>