

11D3-3

Characterization of Metal/Semiconductor/Metal Photo Diode for Optical Interface of Single-Flux-Quantum Circuit

Satoshi Shinada, Hirotaka Terai, Naoya Wada, Zhen Wang, Tetsuya Miyazaki
National Institute of Information and Communications Technology,
4-2-1 Nukui-Kitamachi, Koganei, Tokyo, 184-8795 Japan
E-mail : sshinada@nict.go.jp

Abstract We fabricated and characterized a metal/semiconductor/metal photo diode for optical interface of a single flux quantum circuit, which could be a high-speed and low-power-consumption buffer memory in the optical packet switch.

1. Introduction

An optical packet switch [1] is an important technique for a future optical packet network. However, a buffer memory which can avoid the packet collision is one of components to be improved for the practical use. A conventional buffering technique using a fiber delay line can make a system huge with increasing a number of ports. Also, a semiconductor memory such as a SRAM can be used, but the physical size and power consumption required for a serial parallel conversion might be problems as the system scale increases.

We have proposed to use a single-flux-quantum (SFQ) circuit [2] as the buffer memory [3]. This circuit can operate as logic and/or memory circuits over 100 GHz clock frequency with extremely low power. By applying the SFQ circuit to the buffer memory, optical packet can be stored without reducing its data rate. The most serious problem in the SFQ technology is the interface between room temperature and cryogenic environment. In spite of the high internal clock, the input/output bit rate is limited to 10 Gbps due to a large thermal load through a metal coaxial cable. Therefore, the optical interface with smaller thermal load is desirable for higher data transmission. Figure 1 shows a schematic of the SFQ circuit with optical input and output fibers. A mutual conversion between optical and SFQ signals is an important issue.

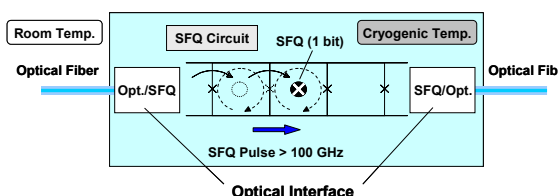

Fig.1 Schematic of a SFQ circuit with optical interfaces. Smaller thermal load and higher data transmission can be realized by replacing a conventional metal coaxial cable by an optical fibers.

In this paper, we fabricated and characterized a metal/semiconductor/metal photo diode for the optical input interface of the SFQ circuit.

2. Implementation of SFQ circuit and photo diode

We proposed to use the multi-chip module (MCM) technique for an implementation of a SFQ circuit and a photo diode (PD) as shown in fig. 2. The SFQ chip and the PD chip are connected by using a flip chip bonding technique on same wafer. The transmission through the solder bump is over 100 GHz and a low loss transmission between the chips is realized by superconducting micro strip lines in the cryogenic environment. We used a metal/semiconductor/metal photo diode (MSM-PD) as a detector for the input interface. The MSM-PD has a simple interdigitated finger electrodes and a flat structure, therefore implementation with a SFQ circuit can be easy. For exciting the SFQ pulse by the communication wavelength band optical signal (1550 nm band), we fabricated a MSM-PD on InGaAs which was grown on the InP substrate, which could become the MCM wafer.

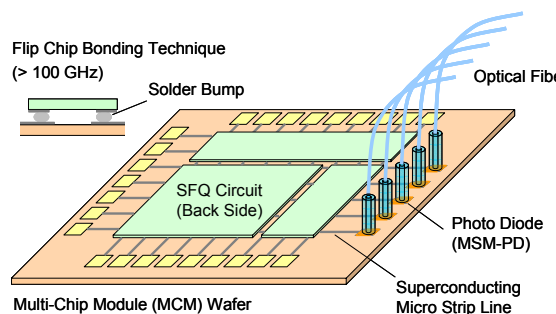

Fig.2 Implementation of SFQ circuits and MSM photo diode. SFQ circuits and optical modules can be connected by a flip chip bonding on a multi chip module.

3. Fabrication and characterization of MSM-PD

Figure 3 shows a schematic structure of a MSM-PD fabricated on the InGaAs/InP wafer. The top layer of InAlAs was for suppressing the dark current [4]. The interdigitated finger was fabricated by using an electron-beam lithography and a metal lift off process. A photo current of MSM-PD was conducted through a coplanar waveguide.

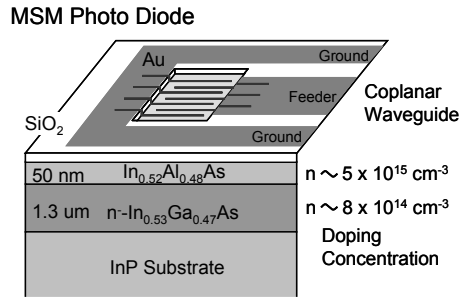

Fig.3 Schematic structure of a MSM-PD on InGaAs/InP.

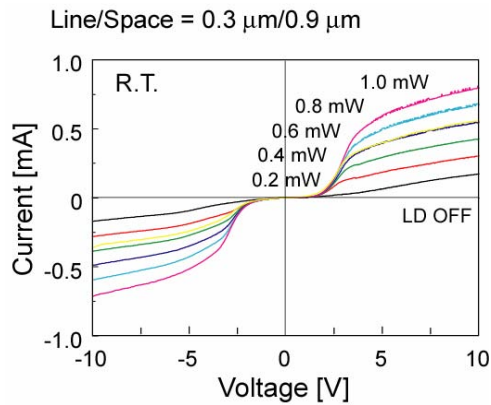

Fig.4 Current and voltage characteristics of MSM-PD on InGaAs/InP. The PD had 0.6 A/W sensitivity at a 1550 nm input laser.

Figure 4 shows current and voltage characteristics of MSM-PD with 0.3 μm wide lines and 0.9 μm wide spaces as a function of the input power (CW laser). The sensitivity of 0.6 A/W was obtained at a bias voltage of 0.5 V and was sufficient to excite a SFQ even by the power using in a conventional fiber communication without an amplifier.

For evaluating the time response of MSM-PD, we used an experimental setup as shown in fig. 5. An optical pulse with FWHM of 1.5 psec was generated by a mode-locked laser diode (MLLD) and irradiated to the MSM-PD, which was mounted in a liquid helium flow type cryostat with an optical access window. The photo current was output from the electrical output port. Figure 6 shows the pulse response of MSM-PD with 0.3 μm wide lines and 1.2 μm wide spaces. The FWHM of 30 psec and the decay time of less than 100 psec were obtained at both room temperature and cryogenic environment, and the estimated bandwidth is about 10 GHz. The higher response would be realized by a MSM-PD with narrower space.

4. Conclusions

We have proposed to use a SFQ circuit as an optical buffer memory in the optical packet switch and developed an optical input interface for exploiting the high speed throughput of SFQ circuit. The MCM technique could realize the implementation of some

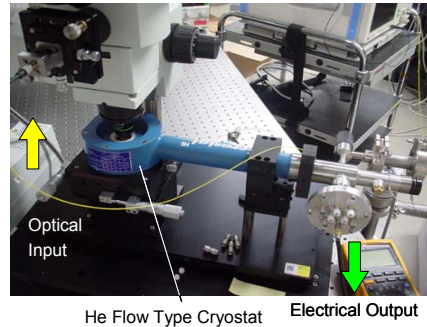
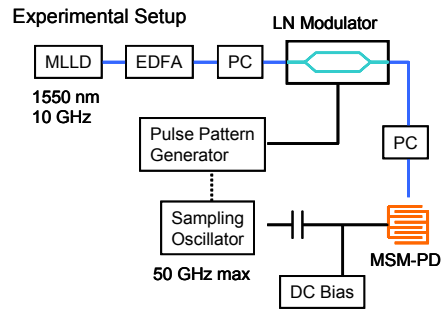

Fig.5 Experimental setup for measuring the response time of the MSM-PD in the cryogenic environment.

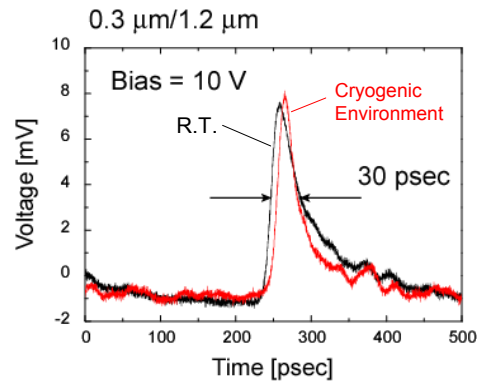

Fig.6 Pulse response of MSM-PD. A FWHM of an incident pulse was 1.5 psec generated by a 1550 nm wavelength mode-locked laser.

functional SFQ circuits and optical modules on one wafer. We fabricated the MSM-PD, which was suitable for MCM wafer, and characterized it. The sufficient sensitivity for exciting a SFQ was obtained in the cryogenic environment. The bandwidth of 10 GHz would be increased by a MSM-PD with narrower spaces.

References

- 1 H. Furukawa et al, OFC2006, OWP3, Anaheim, March, 2006.
- 2 K. Likharev et al, IEEE Trans. on Appl. Supercond., vol. 1, pp. 3-28, 1991.
- 3 S. Shinada et al, ECOC2006, We3.P.71, Cannes, September, 2006.
- 4 J. B. D. Soole et. al, IEEE Photon. Technol. Lett., vol. 1, pp. 250-252, 1989.