

Suppression of electromagnetic radiation emission from electric vehicles: an engineering practical approach

Guo Jiandong, Wang Chuanqi, Ding Yifu, Jiang Li, Lv Yan
 China Automotive Technology & Research Center Co., Ltd.
 Tianjin, China
 guojiandong@catarc.ac.cn

Abstract—When a certain electric vehicle in GB/T 18387-2008 test, the magnetic radiation emission exceed the limits. It can be found that the interference source are the high voltage driving system of motor controller according to the near field and far field inspection. By applying filter elements and changing the grounding path, this paper present an optimization approach to improve the EMC performance of electric vehicles (EVs) which has been proved to be engineering practical.

Keywords—GB/T 18387-2008; electric vehicles; electromagnetic radiation

I. INTRODUCTION

The electric field and magnetic field limits specified in GB/T 18387-2008 standard are shown in Table 1 and Table 2 [1] many vehicles failed in the first test attempt, and then in the process of rectification or mitigation a large number of external temporary methods were used, such as magnetic ring filter on harness and a large number of copper foil shielding, although the final result can meet the standard requirements, but in the subsequent mass production, the consistency and effectiveness of measures cannot be guaranteed. In this paper, through far-field chamber measurement and near-field positioning, rectification from radiation source is performed, standard requirements are fulfilled in a low cost way, which is also easy to implement in the mass production stage.

Table1. The limit value of electric field emission

frequency	level dB($\mu\text{V}/\text{m}/\text{kHz}$)
9 kHz ~ 4.77 MHz	$99.9 - 20\log_{10}(\text{Freq}(\text{MHz})/.009)$
4.77 MHz ~ 15.92 MHz	$154.4 - 40\log_{10}(\text{Freq}(\text{MHz})/.009)$
15.92 MHz ~ 20 MHz	$89.4 - 20\log_{10}(\text{Freq}(\text{MHz})/.009)$
20 MHz ~ 30 MHz	22.5

Table2. The limit value of magnetic field emission

frequency	level dB($\mu\text{A}/\text{m}/\text{kHz}$)
9 kHz ~ 4.77 MHz	$48.4 - 20\log_{10}(\text{Freq}(\text{MHz})/.009)$
4.77 MHz ~ 15.92 MHz	$102.9 - 40\log_{10}(\text{Freq}(\text{MHz})/.009)$
15.92 MHz ~ 20 MHz	$37.9 - 20\log_{10}(\text{Freq}(\text{MHz})/.009)$
20 MHz ~ 30 MHz	-29.0

II. INTRODUCTION TO VEHICLE ELECTRICAL TOPOLOGY

Electric vehicles (EVs) use high-voltage and high-power electronic components, such as traction motors, motor

controllers, DC / DC converters, high-voltage traction batteries. Comparing to traditional cars, EVs equipped with more electronic equipment, such as electric powered steering, air conditioning compressor and PTC heating element, brake vacuum pump, electronic parking brake, etc. High-voltage power electronic switching devices are very easy to produce electromagnetic interference through conduction, coupling or radiation, so there is a big challenge in developing the EMC performance of electric vehicle. In order to better analyze the electromagnetic compatibility of the vehicle, Figure 1 shows the topology diagram of the electrical system from one rectification project, which could give a general overview of the working principle and guiding the following research.

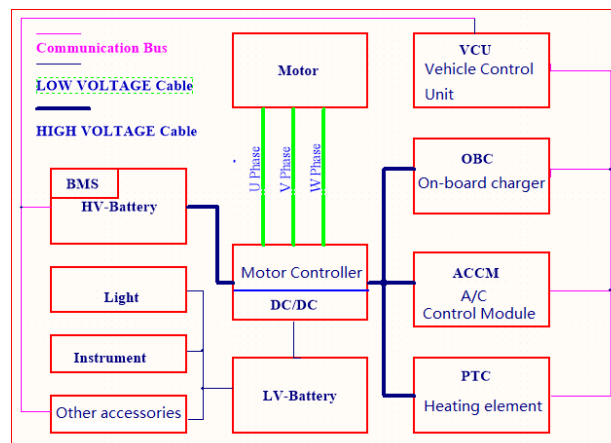

Fig 1. Topology diagram of the electrical system

III. ANALYSIS OF VEHICLE PRE-COMPLIANCE TEST DATA AND POSITIONING

The pre-compliance test has been carried out in the 10m semi-anechoic chamber. Preliminary result shows that the magnetic field from the right side of the vehicle exceeds the limit line seriously. The test setup is shown in Figure 2 and the test data is shown in Figure 4 and Figure 5. The electric field test setup is shown in Figure 3 which has passed the test. During the test, the motor controller unit, DC-DC converter and battery pack are operating in normal condition with all of the low-voltage components in working order. In addition, as the high integration of the on-board high voltage components, multiple components are installed in the limited space of the

front chassis, which are not easy to be disassembled and increase the difficulty to position the interference source. According to rectification experience, most of the interference sources are the on-board high-voltage components. In order to mitigate the interference, the source must be determined exactly using process of elimination. In the process, the on-board components are tested individually, after disconnecting A/C, PTC and on-board charger, leaving only the motor controller powered on, the results in Figure 6 still exceeds the standard limits, so the main source is determined to the motor controller. In the further step, hand-held spectrum analyzer is used for near field scanning, the near field scanning result of high-voltage DC harness near motor controller is shown in Figure 7.

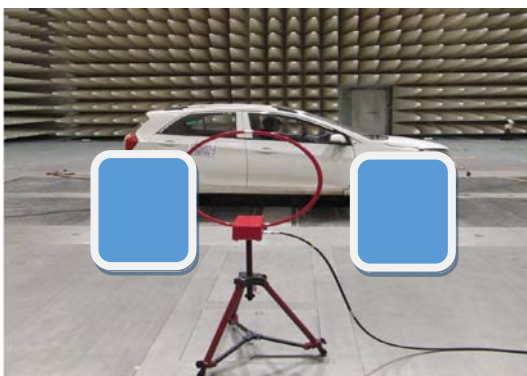

Fig.2 The loop antenna plane is parallel to the right side of the vehicle



Fig.3 The rod antenna is located in the right side of the vehicle

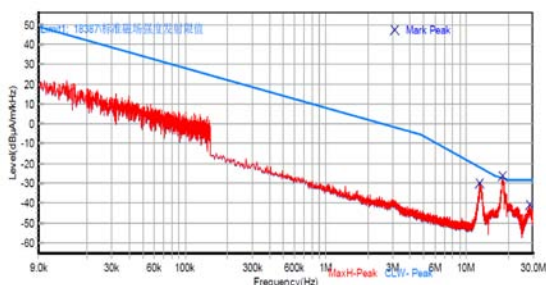

Fig.4 The loop antenna plane is parallel to the right side of the vehicle, 16km/h

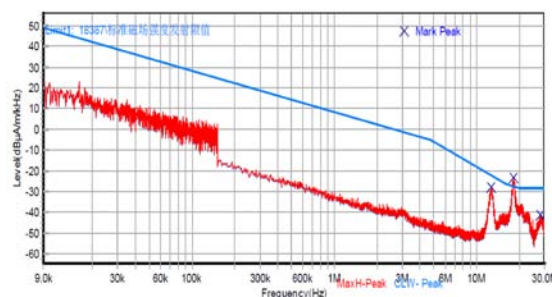

Fig.5 The loop antenna plane is parallel to the right side of the vehicle, 64km/h

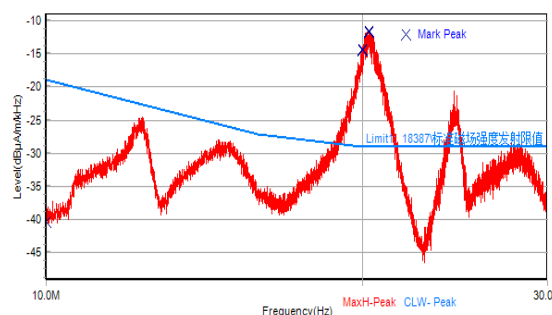

Fig.6 The loop antenna plane is parallel to the right side of the vehicle, 40km/h

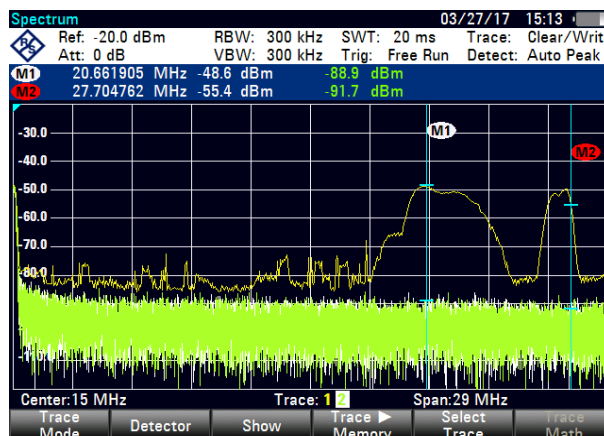

Fig.7 Scan result of High-voltage DC harness of motor controller in near field

By comparing the test results, the emission exceeds the limit line most serious when the magnetic field antenna plane is parallel to the right side of the vehicle. There is a peak around 12.5MHz by exceeding margin limit for 11.9dB. Another peak appears in 18.03MHz by exceeding 4.42dB.

IV. ANALYSIS OF DISTURBANCE FROM DIFFERENTIAL-MODE、COMMON-MODE CURRENT

The main reason that the near field electromagnetic emission of electric vehicles exceeds the limit line is the distribution parameters between high-voltage battery case and body. The distribution parameters are highly related to the layout of the battery. When the large current fluctuates, the potential of the battery negative pole and the body changes.

The fast change rates of current and voltage directly cause the conduction and radiation emission problems. In addition, the parasitic parameters inside the IGBT during the operation of the inverter can also cause the problem of differential mode signal interference. The simple topology of the power system is shown in Fig.8. In Fig. 9 two differential mode signal interference paths are shown. One path (Inverter differential mode path) is the interference source flows through the upper and lower halves of inverter, and then back to the power battery. The other path (Motor circuit differential mode path) is the interference source flows from the HV-DC harness to the inverter and then to the motor, and finally returns to the HV-DC harness. Figure 10 shows two common mode interference paths. Common mode interference problem is caused by ground potential difference between the inverter, motor and HV battery.

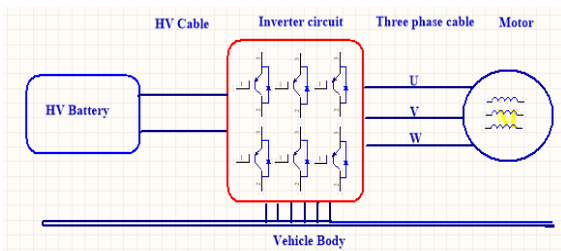

Fig.8 Simple topology of power system

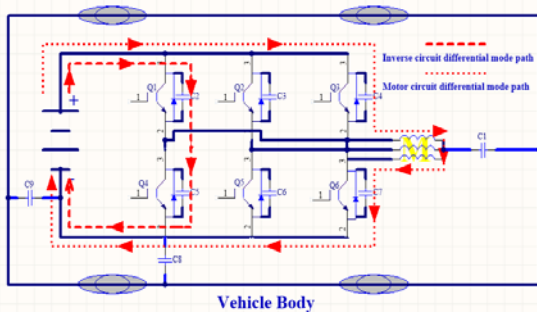

Fig.9 Analysis of differential-mode interference

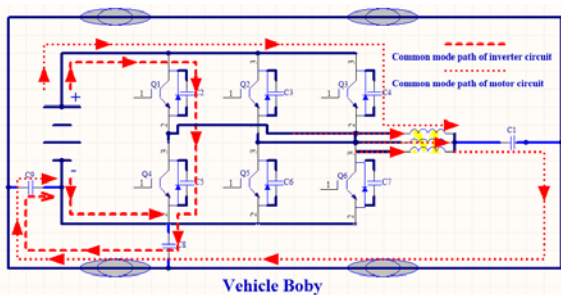

Fig.10 Analysis of common-mode interference

V. ENGINEERING PRACTICAL APPROACH FOR EMISSION MITIGATION

In order to solve the common mode and differential mode radiation emission generated by motor controller, there are two improvements for path 1 and path 2 in Figure 11. Firstly, in path 1, applying three capacitors on negative and positive of high voltage power supply port. The 3dB bandwidth at the

resonance point of the three capacitors lies exactly at the frequency band where the noise is needed to be filtered. Then these six capacitors are encapsulated in a 3D-printed supporting structure, which could be mechanically fitted in the motor controller, in a both time and cost effective way, from the engineering practical point of view this is also a mass-producible rectification approach. Secondly, in path 2, the L-C filter circuit is built using the resonance characteristics of capacitors and inductors, as shown in Figure 12. The structure and parameters of the filter are obtained through simulation and test, which have good filtering effect. Figure 13 is the simulated insertion loss diagram for LC filter circuit. The formulation used to design the resonant frequency of a filter is shown in (1). Verified by hand-made filter board, filter PCB is carefully designed and fitted in motor controller. The installation location and method is shown in Figure 14, which not only meet the needs of rapid rectification but also to ensure that rectification does not affect other functions of product.

$$f_c = \frac{1}{2\pi\sqrt{LC}} \tag{1}$$

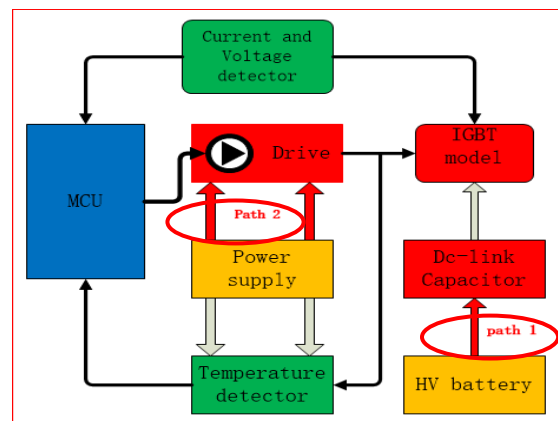

Figure 11 Rectification measures imposed location

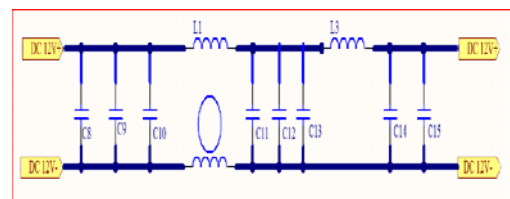

Figure 12 Control board to driver board circuit filter diagram

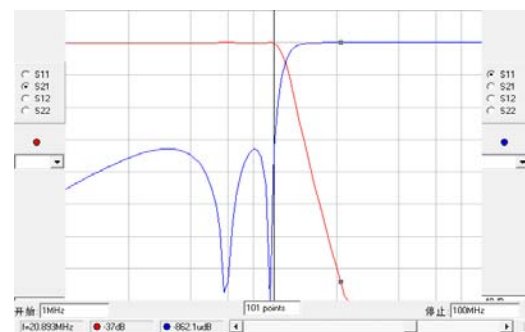

Figure 13 Simulation insertion Loss of filter

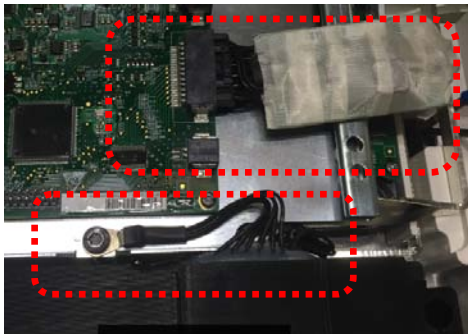

Figure 14 Installation location and method

VI. REGRESSIVE VERIFICATION

After positioning the source of interference and applying rectification measures, the final test results are shown in Figure 15 to Figure 22.

The red line is the test result after rectifying, and the green line is the original test result.

Comparing the data, it can be founded that since the resonance is eliminated by the inductance and capacitance, the rectification methods has a major effect on the 10-30MHz frequency band, the maximum optimized margin is about 12 dB.

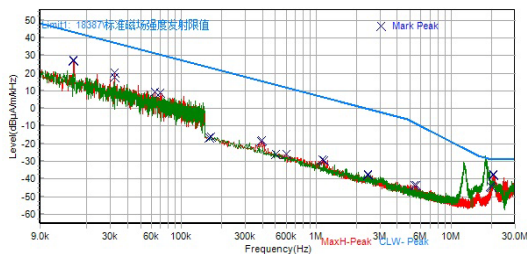

Figure 15 Vehicle speed 16km/h, loop antenna plane is parallel to the right side of vehicle

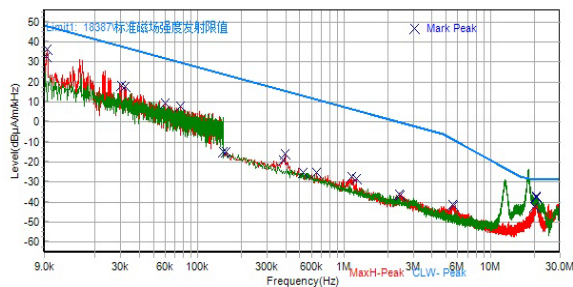

Figure 16 Vehicle speed 16km/h, loop antenna plane is perpendicular to the right side of vehicle

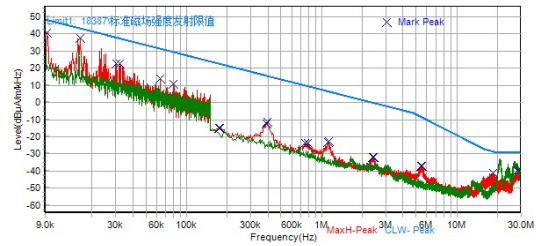

Figure 17 Vehicle speed 16km/h, loop antenna plane is parallel to the right side of vehicle

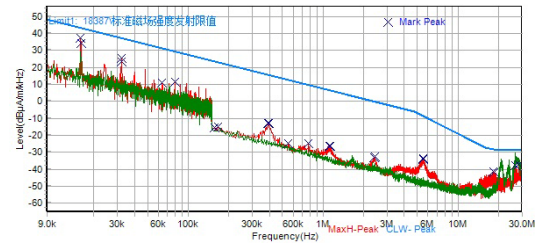

Figure 18 Vehicle speed 64km/h, loop antenna plane is parallel to the right side of vehicle

VII. CONCLUSION

EMC is one of the important attributes of the vehicle electrical system, various factors should be considered such as functional integrity of vehicle electrical components, reliability, cost, light weight, etc. For an engineering practical EMC rectification approach, in the develop stage, both functional integrity and EMC conformity have to be considered, methods like grounding and filtering if designed in early stage could be of the lowest cost and most effective.

REFERENCES

- [1] Zeng Bo, Deng Junyong, Lin Daoqi, Lin Qing, Liu Guorong. Comparison of below 30MHz electric vehicle EMI measurements method standard[J]. China Measurement & Test ,2016,(09):11-14.
- [2] Qi Meng. The Analysis And Optimization Of Electromagnetic Compatibility Of Electric Vehicles[D].Hebei University of Technology,2014.
- [3] Gao Xinjie, Bai Jian, Zhang Hongchao. Rectification on Electromagnetic Radiation Interference of Electric Vehicle[J]. Safety&EMC,2013,(03):58-60+106.
- [4] Cai Huaqiang, Cui Qiang. Analysis of Difference between GB/T 18387-2008 and SAE J 551-5:2012[J]. Safety&EMC,2013,(01):26-28.
- [5] Ji Shiming, Liu Daliang. Study on conducted EMC of electric vehicel[J]. Journal of Mechanical & Electrical Engineering,2012,(03):359-364.
- [6] Sun Tielei. Test and Analysis on Common Mode Interference Radiation of a Certain Electric Vehicle[A]. 2009 SAE-China Congress PROCEEDINGS[C].China Automotive Engineering :,2009:4.

Liu Qingsong, Xu Xianglin, Li Bin. Difference of electric vehicles new and old national standards between GB/T 18387-2008 and GB/T 18387-2001[J]. Bus Technology and Research,2009,(04):48-50