

## Road-to-vehicle Visible Light Communication Using High-speed Camera in Driving Situation

H. Chinthaka N. Premachandra, Tomohiro Yendo, Mehrdad Panahpour Tehrani, Takaya Yamazato, Hiraku Okada, Toshiaki Fujii, and Masayuki Tanimoto

**Abstract**—Intelligent Transport System(ITS) has been proposed to give solutions for traffic problems such as traffic accidents and traffic jams. On the other hand, high frame rate image techniques are getting popular in last several years. In this paper, we propose a Visible Light Communication(VLC) system using high frame rate techniques for Intelligent Transport System. Here, the communication between infrastructure and the vehicle is approached using an LED array as a transmitter and on-vehicle high speed camera as a receiver. The LEDs in the transmitter emit light in 500Hz and the emission patterns are used to achieve communication, capturing them in high frame rate(1000fps) utilizing a high-speed camera. The images captured by high-speed camera are processed to find the transmitter, track the found transmitter, and capture the LED lighting pattern of transmitter in consecutive frames. In our previous work, we proposed algorithms to finding and tracking. In this paper, we introduce method to capture the lighting pattern of the transmitter. Then, out door communication experiments were conducted to confirm the effectiveness of the proposed VLC system.

### I. INTRODUCTION

Intelligent Transport System (ITS) has been introduced to control the traffic problems such as traffic jams and traffic accidents with the development of information technology. Our research group conduct research mainly on assistance for safe driving as an area of ITS. On-vehicle cameras play a great role in capturing the images of external environment in many driver assistant systems. Some studies have been conducted for detecting obstacles, traffic signs, signal lights, and so on[1][2][3]. Conventional video cameras(video cameras with a frame rate of e.g. 30fps) are used in these systems.

Recently, high-speed cameras are getting popular and they are also applied in ITS as well as in other scientific research, military test, and industry. High speed cameras can capture more information of fast moving objects and changing objects in high frequency, compared to the conventional video cameras. Specific image processing technique may also be necessary when these cameras are used. On the other hand, the LED traffic light are getting popular due to the advantages of longer operating life, lower power

This work was partially supported by the Ministry of Internal Affairs and Communications, Strategic Information and Communications RD Promotion Programme(SCOPE)

H. Chinthaka N. Premachandra, T. Yendo, M. P. Tehrani, T. Yamazato and M. Tanimoto are with the Graduate School of Engineering, Nagoya university, Chikusa-ku, Nagoya, 464-8603 JAPAN  
chinthaka@tanimoto.nuee.nagoya-u.ac.jp

H. Okada is with the Graduate School of Science and Engineering, Saitama University, Saitama, Japan

T. Fujii is with the Graduate School of Science and Engineering, Tokyo Institute of Technology, Tokyo, Japan

consumption, and so on. In this study, we propose a road-to-vehicle Visible Light Communication(VLC) system using an LED array as a transmitter and an on-vehicle high-speed camera as a receiver as shown in Fig.1. Here, an LED array is used instead of LED traffic light in the experiments.

In the proposed VLC system, the LED array emits light synchronized with a 500Hz clock signal. This emission is conducted sequence by sequence. As mentioned above, for capturing this emission, a camera should have a high frame rate. The conventional video cameras (video cameras with a frame rate of e.g. 30fps) cannot be used for this purpose. So, we use a high-speed camera to capture this emission to achieve communication. Here, the emission means the LED lighting patterns in the consecutive frames. In the experiments, high speed camera fixed on the vehicle captures images in 1000fps, while vehicle is moving. To achieve communication, first the emitting LED array should be found and then it should be tracked in consecutive frames by processing the images from the high speed camera. The emission patterns of the transmitter should be captured while it is being tracked. In our previous works[4], we proposed methods for finding and tracking, and in this paper, we mainly propose methods for capturing the lighting patterns of the transmitter in consecutive frames(emission pattern). For this purpose, it is necessary to verify the lighting and non-lighting LEDs in each frame. In this study, we conduct communication at a distance between 20m and 70m from the transmitter. When emitting transmitter is set in the outdoor environment, the pixel values for lighting LEDs in the images, are mainly depend on the distance between the camera and transmitter, affection of other outdoor light source such

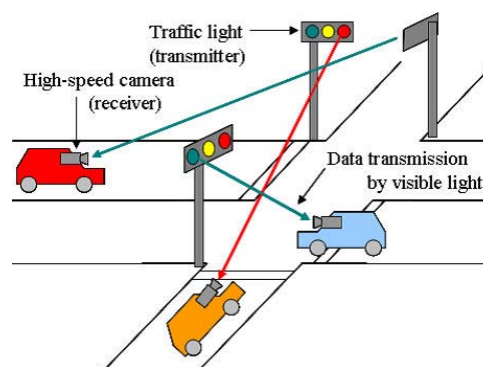

Fig. 1. Road-to-Vehicle Visible Light Communication

as sun, whether condition such as sunny or cloudy, and so on. A new method is proposed to verify the lighting and non-lighting LEDs based on Othu's binarization method[5]. After this verification, the LED positions are gained using a sub pixel measurement to capture the LED lighting pattern in each frame. The out door communication experiments were conduct to confirm the effectiveness of the proposed *VLC* system. According to experiments, it showed that, *VLC* can be achieved using high frame rate techniques.

This paper consists of six main sections to explain our project work. A brief discription about *VLC* and proposed system for applying *VLC* in *ITS* is detailed section 2. The emission of the transmitter and main image processing steps for the receiver are explained in the section 3 and the section 4 respectively. The experimental results are described in the section 5. The section 6 concludes the paper.

## II. VISIBLE LIGHT COMMUNICATION

Visible Light Communication(*VLC*) is a wireless communication method using luminance, transmitting data by emitting light. It is able to transfer data by emitting light source, and able to receive them with a light sensor. There are several advantages in this communication method compared to other wireless communication methods, such as radio waves and infra-red light. The visible light is not harmful to human body, and it is able to transmit with high power. There are not legal limitations for any existing light source, such as room illuminations and displays to be used. It can be used at the places where radio waves cannot be used, for examples, hospitals and areas around precision machines.

Komine and Nakagawa[6] have achieved *VLC* using illumination light. It is a communication between PCs and illumination light, and considered as an alternative method for the wireless LAN. As a latest application of *VLC* in *ITS*, Suzuki et al. [7] introduced a support system for visually impaired person by utilizing *VLC* technology. In the above both system, *VLC* is conducted between stable transmitter and stable or slowly moving(average walking speed of human being  $< 5km/h$ ) receiver. In this paper we

achieved *VLC* between stable transmitter and faster moving receiver(vehicle speed  $> 30km/h$ ).

### A. Proposed system for applying *VLC* in *ITS*

Okada et al. [8] has been applied *VLC* in *ITS* using an LED traffic light as a transmitter and a photodiode(*PD*) as a receiver. In their system, all the LEDs in the transmitter is considered as one transmitter as shown in Fig. 2(a). Each LED or small group of LEDs in the transmitter cannot be identified individually, when a *PD* is used as receiver. For this reason, parallel data communication cannot be conducted with *PD*(Fig. 2(a)). Figure 2(b) illustrates the structure of the proposed *VLC* system using an LED traffic light(LED array) as a transmitter and a high-speed camera as a receiver. If the LEDs in the transmitter could be recognized individually, it is possible to use each of them as a separate sub-transmitters communicating in parallel at the same time. In other words, each LED transmits different data in parallel and they are received at the same time. As a result we can dramatically increase the communication speed by modulating each LED individually. Moreover, we can communicate with several transmitters and receive different information in parallel. These are the main advantage of using a camera as a receiver(Fig. 2). However, using a camera as a receiver has some disadvantages. The camera should have high frame rate to achieve good communication speed. For this purpose, image processing in the receiver should be in real time and it might be harder on a computer. We plan to achieve this using hardware. Another issue is the modulation method. Since this is a unique communication method using visible light and image, it requires particular modulation method which considers the characteristics of the communication. We use hierarchical coding[9] for Visible Light Communication, which modulates data on spatial frequency and enables long distance communication.

The transmitter used for the experiments is square in shape as shown in Fig. 3 and it consists 256( $16 \times 16$ )LEDs. Each LED individually or small neighboring group of LEDs individually are considered as sub-transmitters in the communication experiments. Figure 4 illustrates the high-speed camera which is used as the receiver in the experiments and it can take image in high frame rates. As mentioned above,

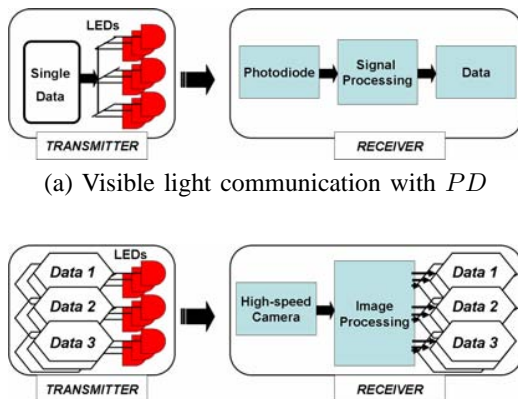

Fig. 2. Comparison of *VLC* with *PD* and High-speed camera



Fig. 3. LED array used as transmitter

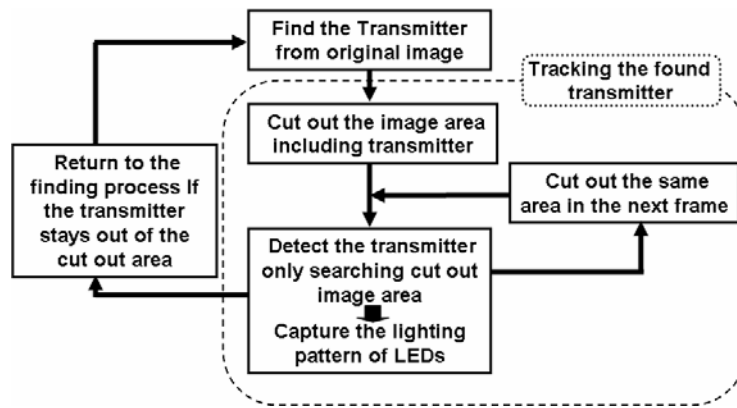

Fig. 5. The main image processing steps for the receiver

it takes images in  $1000fps$  in the experiments.

### III. EMISSION OF THE TRANSMITTER

In this paper, as mentioned above, we conduct communication experiments at a distance between  $20m$  and  $70m$  from the transmitter. The high-speed camera takes images with resolution of  $1024 \times 512pixels(I_{org})$ . When the transmitter is far from the  $40m$ , the transmitter is appeared in the image approximately with  $16 \times 16pixels$ . If the distance between transmitter and receiver exceeds  $40m$  the resolution of the camera is not enough to identify each LEDs separately. For this reason, each LED cannot be used as one sub-transmitter. In this paper, we set 4 neighboring LEDs as one sub-transmitter. Here the emission is conducted keeping 4 neighboring LEDs in same situation(ON or OFF). With this setting,  $64(8 \times 8)$  sub-transmitters( $s_t$ ) can be used for parallel communication and the size of the transmitter(LED array) in the image become approximately  $8 \times 8pixels$  when the camera is  $70m$  far from it. The communication speed( $C_s$ ) is  $32kbps$  and this value can be calculated following the Equation 1.

$$C_s = k \times \frac{\log 2^{s_t}}{f_r} \quad (1)$$

where  $k = \frac{e_f}{f_r}$



Fig. 4. High-speed camera used as receiver

In the above Equation 1,  $f_r$  and  $e_f$  mean the frame rate of the high-speed camera and light emitting frequency of the transmitter(LED array) respectively. As mentioned above, in this paper  $f_r = 1000fps$  and  $e_f = 500Hz$ , according to this,  $k = 0.5$ .

There are some image processing techniques are necessary to capture the emission from the images taken by the high-speed camera.

#### A. Finding and tracking the transmitter

In this paper, we mainly use the method introduced in our previous works[4] for finding and tracking. It is possible to find and track the transmitter when all LEDs emit light randomly(change the lighting LEDs in the transmitter randomly in consecutive frames) using these methods. The idea for finding the transmitter is to calculate the absolute differences( $D_{total}$ ) between current frame and some just previous  $m$  consecutive frames. These differences are projected to new image( $DI$ ). Then the transmitter is extracted by conducting some other image processing steps for  $DI$ .  $m$  is set as 4 in the experiments. After finding the transmitter, it is tracked only searching the corresponding  $I_{cut}$  in consecutive frames. In this paper, all LEDs are randomly emitted. Figure 7 illustrates the lighting patterns of four consecutive frames taken by the high-speed camera when random emission is conducted. But, when all the LEDs emit light randomly, it is difficult to track the transmitter, because, the boundary of the transmitter might not properly appear in some frames. We previously proposed a method[4] for this problem and it includes two main steps as edge-based step and optical flow-based step. In the cases of Fig. 7(a) and (b), first edge detection is conducted, then the bounding of the transmitter are determined by calculating circumscribing rectangle of the edge component belongs to the lighting LEDs. This edge-based method track the transmitter by capturing bounding of the transmitter in consecutive frames. If this edge based method could not determine the bounding of the transmitter, it is tracked using the Lucas Kanade optical flow method[10]. Figure 7(c) and (d) are examples for this situation.

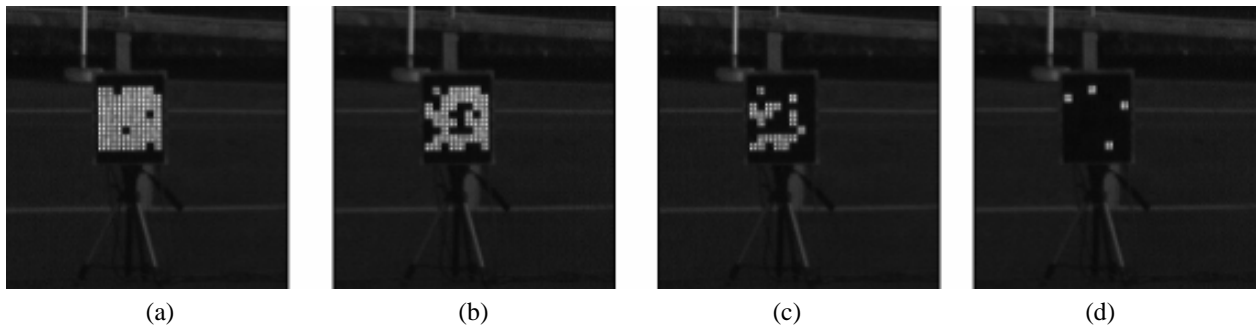

Fig. 7. Examples of four different lighting patterns of the transmitter

 Fig. 6. An example of the  $I_{cut}$  on an  $I_{org}$  taken by high-speed camera

### B. Capturing the lighting pattern of the transmitter

1) *Verification of lighting and non-lighting LEDs:* In this paper, outdoor experiments are conducted. When emitting transmitter is set in the outdoor environment, the pixel values for lighting LEDs in the images are mainly depend on the distance between the camera and transmitter, affection of other outdoor light source such as sun, whether condition such as sunny or cloudy, and so on. Figure 8 shows example images of the transmitter taken at the different distances far from the transmitter. As shown in Fig. 8(d), even the distance is shorter, moire phenomenon was occurred due to the emission of the transmitter. For this reason the pixel value distribution of the lighting LEDs is not stable as shown in Fig. 8(d). A robust method is needed to verify lighting and non-lighting LEDs under these circumstances. To solve this, we first globally applied Otsu's binarization method[5] to have lighting LED area with white pixels and non-lighting LED area with black pixels. This method was not robust enough for this verification(see Fig. 9). But, as shown Fig. 9, it was effective when the distance between transmitter and receiver exceeds approximately 50m.

$$\sigma_W^2 = \omega_1 \sigma_1^2 + \omega_2 \sigma_2^2 \quad (2)$$

$$\begin{aligned} \sigma_B^2 &= \sigma^2 - \sigma_W^2 \\ &= \omega_1 (\mu_1 - \mu)^2 + \omega_2 (\mu_2 - \mu)^2 \\ &= \omega_1 \omega_2 (\mu_1 - \mu_2)^2 \end{aligned} \quad (3)$$

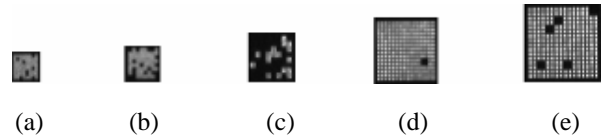

Fig. 8. Appearance of the transmitter in the images from different distances, (a)70m ~ 60m, (b)60m ~ 50m, (c)50m ~ 40m, (d)40m ~ 30m, (e)30m ~ 20m far from the transmitter

where  $\mu = \omega_1 \mu_1 + \omega_2 \mu_2$

In the Otsu's method, first image is divided into two classes and then calculate variance within two classes( $\sigma_W^2$ ) or the variance between two classes( $\sigma_B^2$ ) following the Equation 2 and 3 respectively. The weights ( $\omega_{1_i}$  and  $\omega_{2_i}$ ,  $i = 1 \sim 256$ ) are the probabilities of the two classes separated by  $t_i$ ,  $i = 0 \sim 255$ ). The threshold( $t$ ) for binarization(here, to verify the lighting and non-lighting LEDs) can be determined when  $\sigma_B^2$  takes maximum value or  $\sigma_W^2$  takes minimum value. But, in the implementation, calculation of  $\sigma_B^2$  is quicker. For this reason,  $\sigma_B^2$  is used to gain the threshold.

In this paper, Otsu's method is not globally applied to entire image. Here, first, image is divided into local regions( $I_{lr}$ ). This division is conducted, if the transmitter image area( $I_{tra}$ )  $> 16 \times 16$  pixels and the size of the  $I_{lr}$  is  $8 \times 8$  pixels. After making this division, the remaining image areas are combined to neighboring divisions. The binarization thresholds( $Th_{lr_i}$ ) for each  $I_{lr}$  are calculated

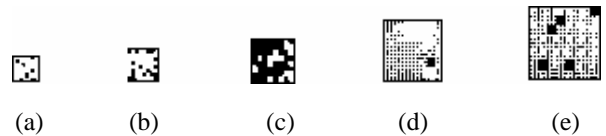

Fig. 9. Binarization of images in Fig. 8 using Otsu's method

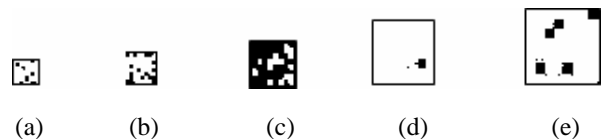

Fig. 10. Binarization of images in Fig. 8 using proposed method

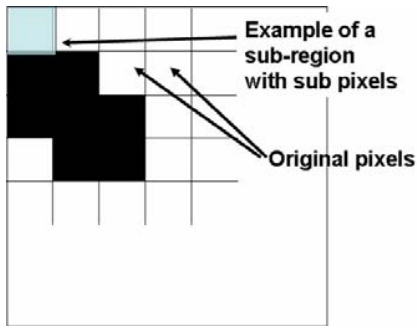

Fig. 11. Sub-regional division of transmitter image area using sub-pixels

separately using Otsu's method. The minimum value of ( $Th_{tr_i}$ ) is globally used to verify the lighting and non-lighting LEDs.

As mentioned above, white pixels are set for the lighting LEDs and black pixels are set for the non-lighting LEDs as shown in Fig. 10. Figure 9 and 10 show the binarization of the images in the Fig. 8 using Otsu's method and proposed method respectively. According to experiments, proposed method is effective to verify the lighting and non-lighting LEDs. After this verification, LED positions in the images are determined as detailed in the next section.

2) *LED position and pixel value determination*: As explained in section 3, 4 neighboring LED groups in the transmitter are used as sub-transmitters. So, the 4LEDs in each group has same lighting situation at every moment. According to this grouping, the total number of LED groups are  $64(8 \times 8)$ . In this paper, it is necessary to identify each group separately and their lighting situation(ON or OFF) as well. According to the distance between transmitter and high-speed camera, the size of the transmitter in the images appears with  $n \times n$  pixels, here  $n = 8 \sim 36$ . Here, in many times, the binarized(binartized by proposed method) image cannot be divided into 64 sub-regions with the pixel units. For this reason, it is divided in to 64 sub-regions using the sub-pixel units as shown in Fig. 11. These each sub-region is corresponded to each 4LED group in the transmitter.

The pixel value  $P_v$  of each 4LED group is picked up following the Equation 4.

$$P_v = \begin{cases} 255 & (A_w > A_b) \\ 0 & \end{cases} \quad (4)$$

The  $A_w$  and  $A_b$  mean the white and black overlapping areas in the sub-region respectively. The pixel value, distributed in maximum area of each sub-region is selected as the pixel value for corresponding 4LED group. Then the lighting pattern in entire transmitter image is determined considering pixel values of all sub-regions.

## IV. EXPERIMENTAL RESULTS

### A. Experimental environment

In the experiments, we fixed the high-speed camera on a vehicle(see Fig. 4) and images were captured while driving between  $30km/h \sim 40km/h$ , towards the transmitter. The moved distance of the vehicle is from  $70m$  to  $20m$ , from the transmitter. Transmitter is emitted light in  $500Hz$  and grayscale images of emitting transmitter were captured by high-speed camera in  $1000fps$  with size of  $1024 \times 512pixels(I_{org})$ . The cut out image area( $I_{cut}$ ) was  $128 \times 128pixels$ . For finding and tracking of the transmitter, we used our previous methods[4], shortly detailed in section 4.1. In this paper, we mainly describe the results of lighting pattern(capturing the lighting situation of 4LED groups individually) capturing of the transmitter in consecutive frames and the measurement of BER.

All the experiments were conducted on a computer having configuration of Intel(R) CoreTM 2 Duo,  $3.00Hz$  and  $2.00GB$  RAM.

### B. Results

We captured 4 image sequences under above mentioned experimental environment and different outdoor conditions such as sunny, cloudy, and very dark(night). All the sequences include approximately  $25000frames$ (here, each sequence includes approximately  $6400frames$ ). There are 64, 4LED groups(sub-transmitters) existed in each frame. Table 1 shows the results of capturing the lighting situation(ON or OFF) of 4LED groups individually. Here the average percentage of capturing the 4LED groups lighting situation is used for evaluation. This average percentage at the different distances( $d_1, d_2, d_3, d_4, d_5$ ) from the transmitter are shown in Table 1. When the vehicle move at a distance between  $20m$  and  $40m$ , the lighting situation of 4LED groups could be captured in very high accuracy. But, when the vehicle move at a distance between  $40m$  and  $70m$ , results are not so good since resolution of transmitter image area( $I_{tra}$ ) get smaller. This would be able to improve by using more high resolution high-speed camera.

The BER was measured to evaluate the communication ability of proposed VLC system. Table 2 shows communication experiment result. Here, when the vehicle move at the above mentioned distances( $d_1, d_2, d_3, d_4, d_5$ ) from the transmitter, average BER values were measured. According to these results, it is possible to achieve video data transmission, when the vehicle move at a distance  $d_1$  since the  $BER < 10^{-6}$ . And the audio transmission can be conducted within  $d_1 + d_2$  since, almost  $BER < 10^{-3}$ .

Above results showed that, it is possible to achieve Visible Light Communication(VLC) between an LED array and a high-speed camera by taking images in high frame rates, as a high frame rate technique.

## V. CONCLUSION

In this paper, we propose a road-to-vehicle Visible Light Communication(VLC) system for Intelligent Transport System(ITS) using high frame rate techniques. Here,

Sequence	$d_1 : 20m \sim 30m$	$d_2 : 30m \sim 40m$	$d_3 : 40m \sim 50m$	$d_4 : 50m \sim 60m$	$d_5 : 60m \sim 70m$
1	100%	99.8%	99.5%	90.2%	79.9%
2	100%	99.9%	99.1%	91.1%	70.1%
3	100%	99.4%	97.0%	92.2%	71.1%
4	100%	99.7%	99.6%	85.6%	74.1%

TABLE I

AVERAGE PERCENTAGE OF CAPTURING THE 4LED GROUPS LIGHTING SITUATION WHEN THE VEHICLE MOVE AT  $d_1, d_2, d_3, d_4$  AND  $d_5$  DISTANCE FAR FROM THE TRANSMITTER

Sequence	$d_1 : 20m \sim 30m$	$d_2 : 30m \sim 40m$	$d_3 : 40m \sim 50m$	$d_4 : 50m \sim 60m$	$d_5 : 60m \sim 70m$
1	0	$1 \times 10^{-3}$	$7 \times 10^{-3}$	$1 \times 10^{-1}$	$2 \times 10^{-1}$
2	0	$1 \times 10^{-3}$	$1 \times 10^{-2}$	$1 \times 10^{-1}$	$3 \times 10^{-3}$
3	0	$5 \times 10^{-3}$	$3 \times 10^{-2}$	$8 \times 10^{-2}$	$3 \times 10^{-1}$
4	0	$3 \times 10^{-3}$	$1 \times 10^{-2}$	$2 \times 10^{-2}$	$2 \times 10^{-1}$

TABLE II

CALCULATION OF  $BER$  VALUE WHEN THE VEHICLE MOVE AT  $d_1, d_2, d_3, d_4$  AND  $d_5$  DISTANCE FAR FROM THE TRANSMITTER

the communicate between infrastructure and the vehicle is conducted using an LED array as a transmitter and on-vehicle high speed camera as a receiver. In this paper we introduce image processing techniques for the receiver. And the communication experiments were conducted under driving situation to evaluate the proposed  $VLC$  system. According to the communication experiment results, it showed that,  $VLC$  can be achieved using high frame rate techniques. As further targets of this work, we plan to improve long distance  $VLC$  by using more high resolution high-speed cameras with image processing.

## VI. ACKNOWLEDGMENTS

This work is partially supported by Strategic Information and Communications R&D Promotion Programme (SCOPE).

## REFERENCES

- [1] B. Hoferlin and K. Zimmermann, Towards reliable traffic sign recognition, *Proc. of IEEE IV Sym.*, pp. 324-329 (2007)
- [2] K. Y. Lee, J. W. Lee, and M. R. Cho, Detection of road obstacles using dynamic programming for remapped stereo images to a top-view, *Proc. IEEE IV Sym.*, pp. 765-770 (2005)
- [3] R. de Charette and F. Nashashibi, Real Time Visual Traffic Light Recognition Based on Spot Light and Adaptive Traffic Light Templates, *Proc. of IEEE IV Sym.*, pp. 358-363 (2009)
- [4] H. C. N. Premachandra, T. Yendo, M. P. Tehrani, T. Yamasato, H. Okada, T. Fujii, and M. Tanimoto, High-speed-camera Image Processing Based LED Traffic Light Detection for Road-to-vehicle Visible Light Communication, *Proc. of IEEE IV Sym.*, pp. 793-798 (2010)
- [5] N. Otsu, A threshold selection method from gray-level histograms, *IEEE Trans. on Systems, Man and Cybernetics*, Vol 9, pp 62-66 (1979)
- [6] T. Komine and M. Nakagawa, Fundement analysis for visible-light communication system using LED lights, *IEEE Trans. of Consumer Electronics*, Vol 150, pp.100-107 (2004)
- [7] K. Suzuki, M. Fujita, Y. Hayashi, and K. Fukuzono, A Study on Visually Impaired Person's Support System Utilizing Visible Light Communication Technology at Signalized Intersections, *Intern. Journ. of ITS Research*, Vol 5, pp.37-45 (2007)
- [8] S. Okada, T. Yendo, T. Yamasato, T. Fujii, M. Tanimoto, and Y. Kimura, On-vehicle receiver for distant visible light road-to-vehicle communication, *Proc. of IEEE IV Sym.*, pp. 1033-1038 (2009)
- [9] S. Arai, S. Mase, T. Yamazato, T. Endo, T. Fujii, M. Tanimoto, K. Kidono, Y. Kimura and Y. Ninomiya, Experiment on Hierarchical Transmission Scheme for Visible Light Communication using LED Traffic Light and High-Speed Camera, *Proc. of IEEE Int. Sym. on Wireless Vehicular Communications(WiVeC'07)*, (2007)