

# IEICE

**Communications Society —GLOBAL NEWSLETTER—**



VOL.43 NO.4

Dec. 2019



A PUBLICATION OF THE COMMUNICATIONS SOCIETY  
The Institute of Electronics, Information and Communication Engineers

## ***IEICE Communications Society GLOBAL NEWSLETTER Vol. 43, No.4*** **Contents**

### ○ Technology Reports

Development of the World's First Web Browser for Mobile Phones .....	2
Tomihisa Kamada	

### ○ From Laboratories

A Foreign Researcher's Journey in Japan: From Bangladesh to UEC and NICT .....	8
Abu Hena Al Muktadir	

### ○ IEICE-CS Activities Now

Report on Communications Society Special Talk and Awarding Ceremony at 2019 IEICE Society Conference .....	10
Toru Takahashi, Takahiko Saba	

Report on ICM English Session at 2019 IEICE Society Conference – BS-4, Network and Service Design, Control and Management – .....	12
Noriaki Kamiyama	

Activities of Technical Committee on Optical Fiber Technologies (OFT) .....	14
Hajime Arao, Hiroshi Watanabe	

Report on the 2 <sup>nd</sup> Indonesia-Japan Workshop on Antennas and Wireless Technology (IJAWT2019) and the 2019 Malaysia-Japan Workshop on Radio Technology (MJWRT2019) .....	16
Hiroaki Nakabayashi	

Report on CS/CQ Joint Session at 2019 IEICE General Conference – BI-5 Applications of Communication Technologies in Various Areas – .....	20
Kenko Ota, Kenji Kanai, Takanori Hayashi, Hideyuki Shimonishi, Jun Okamoto, Daisuke Ikegami, Chikara Sasaki, Yoshiaki Nishikawa, Ryo Yamamoto, Hidenori Nakazato, Jun Terada, Masamitsu Fujiwara, Kazutaka Hara, Kentaro Toyoda	

### ○ IEICE-CS Related Conference Reports

Report on Japan-China Workshop on the Next Generation Mobile Communication Technology and Application 2019 .....	22
Toshihiko Nishimura, Satoshi Suyama	

Nice Teamwork Lead to the Success in International Geoscience and Remote Sensing Symposium (IGARSS) 2019 Yokohama .....	23
Akira Hirose	

Report on EMC Sapporo & APEMC 2019 .....	26
Yoshiki Kayano, Yuichi Hayashi	

Report on OECC/PSC 2019 .....	29
Kimio Oguchi, Akihiro Maruta	
Report on the 18 <sup>th</sup> International Workshop on Assurance in Distributed Systems and Networks (ADSN2019) .....	31
Junichi Funasaka	
Report on 20 <sup>th</sup> Asia-Pacific Network Operations and Management Symposium (APNOMS 2019) .....	32
Hironori Kurokawa, Kiyohito Yoshihara	
Report on International Workshop on Technology Trials and Proof-of-Concept Activities for 5G Evolution & Beyond 5G 2019 (TPoC5GE 2019) .....	34
Yukitoshi Sanada	
Report on the 11 <sup>th</sup> International Conference on Ubiquitous and Future Networks (ICUFN) 2019 .....	35
Seong-Ho Jeong, Takeo Fujii, Dongkyun Kim, Insoo Sohn	
○ IEICE-CS Information	
IEICE-CS Related Conferences Calendar .....	37
CFPs for IEICE-CS Related Conferences .....	39
Special Section Calendar of IEICE Transactions on Communications .....	43
CFPs for Special Sections on IEICE Transactions on Communications .....	44
From Editor's Desk .....	47
IEICE-CS Leaflet .....	48
○ Photogravure	
IEICE General Conference 2020 .....	Back cover

**\*Color Version Available!**

*The PDF (color version) of this issue can be downloaded from IEICE-CS Web site below:*

[https://www.ieice.org/cs/pub/global\\_news.html](https://www.ieice.org/cs/pub/global_news.html)



# Development of the World's First Web Browser for Mobile Phones

Tomihisa Kamada  
TomyK Ltd.



## 1. Introduction

More than 20 years ago in Japan, that is far before iPhone appears in the market, we had a small mobile device, with which we could make a phone call, send and receive emails, check latest news and weather information, and enjoy music and games. It was almost like today's smartphone.

That is "i-mode" of NTT docomo, which is well known as the last most successful Japanese product in the 20<sup>th</sup> century. At that time, the author was leading the project of developing Web browser software at ACCESS Co., Ltd., and we were developing the software to enable i-mode services for mobile phones. Then, mobile phones with Internet capability have spread all over the world (Fig. 1), and mobile Internet industry was started in the early 2000's. The mobile web browser software has been evolved as the platform to enable various applications and services, synchronizing with the evolution of hardware and wireless network (from 2.5G to 3G, then LTE) for more than 10 years.

In this article, we describe the history and interesting background story about the development of web browser for mobile phones, unique technical challenges, market development, and global expansion.

## 2. Enabling "Web Browsing" on Mobile Phones

The idea looks natural and straightforward today that email and browsing functions are realized on mobile phones. But, it was a long way to reach to this point.



Fig. 1 Presenting Mobile Web Browser (the author).  
(3GSM World 2003, current Mobile World Congress)

ACCESS developed communication protocol stacks such as TCP/IP, email software, and browser software for various information appliances, with the company mission of "connecting every device to the network". We foresee the generation will come that all kinds of devices are connected to the network. We design the software to be compact and low power consuming as the "embedded software" for the devices with small memory and low power CPUs.

### (1) Lessons from the failure of Internet-TV

Our first target device of connecting to the Internet was TV set among consumer devices. Because it has large screen, and is suitable for watching contents. We added the function for connecting to the Internet and browsing Web contents. It looked a good idea. We announced the "Internet-TV" solution in 1995, and jointly developed the products with several TV set manufacturers. But, the product was not successful at all. At that time, there was no Wi-Fi and optical fiber. Also, it was still analog TV (low screen resolution). It is obvious that it was too early. The surrounding environment was not ready.

There were many reasons for the failure. Mainly, networking infrastructure and contents were the critical issues. The first problem is setup for connecting the Internet. Because we have to use dial-up method by using telephone line, TV has to be connected to the telephone line. The data speed was also very slow. Especially it was very challenging to connect telephone and TV, which are usually far away in the living room. This issue continued even when LAN becomes available. It was not until Wi-Fi becomes popular that the connecting issue is solved.

The second problem is lack of contents for general TV users. It was still at the early stage of Internet generation. Only early adopters (in the marketing words) started to use the Internet. However, TV users are very general mass users. Internet contents were not ready for those users. In addition, TV users are familiar with videos and broadcasting. It was not acceptable for them to see slow image display in a low-speed network environment. Also, users are in the relax mode and are passive when they are watching TV. TV broadcasting is, so called, "push" service. On the other hand, Internet contents are "pull" service, which let users take active operations such as selections and back and forth. In this sense, Web browsing is not matching to TV in terms of user experiences.

## (2) Word processor, Game console, and PDA

Though the Internet-TV was too early in the market, we were confident that the idea itself of connecting various devices to the Internet and enabling convenient services was the right direction to the future. Our next target was the word processor. Millions of devices were shipped every year. Because the main purpose of word processors is to write documents, it must be natural extension to send the documents via email. We have provided email and browser software to many word processors.

Then, we have proposed Internet function to game console devices and PDAs (Personal Digital Assistants) and commercialized those devices. In addition, we have developed jointly with device partners, many advanced smart devices with Internet function, such as electronic organs (downloading musical score data from the Internet), car navigation systems connected to the Internet, and browser-based reception desk devices. It seems that those are really examples of today's IoT (Internet of Things) devices [1].

## (3) Mobile Phone is the Ideal Target

We have provided embedded Web browser software "NetFront" to various devices. However, there were not mega-hit products. So, we have paid attention to mobile phones as the next target. Because we have experienced to implement browser on PDA with PHS (Personal Handy-phone System), we are confident to realize the same browser function on the mobile phone.

At the same time, NTT docomo started packet data network service (DoPa), which is suitable for the Internet communication protocols. We proposed Web browser for mobile phones to NTT docomo in 1997 spring. The advantage of mobile phones is that there is no need of connecting phone lines and equipping with communication modules, which we faced for Internet-TV. The wireless network function was embedded in the device. Also, users operate mobile phones actively. This user experience is matching to "pull"-type content services.

The only remaining issue was an extensive lineup of contents. We had to collaborate with contents partners. Since the screen size of mobile phones was so small, contents for PCs could not be used for mobile phones. We needed to support contents providers to make their contents available for mobile phones. It was a big challenge for the first time in the world.

## 3. Proposing "Compact HTML" to W3C

When we designed Web browser software for mobile phones, we thought that it is important to define the specifications and guidelines by using the Internet standards as much as possible, and also by taking into account the constraints of mobile phones.

### (1) Fully Utilizing the Internet Resources

ACCESS developed the Internet communication protocol stack TCP/IP for embedded devices, in the early 1980's. We believed that the Internet get spread, and it really happened. At the beginning of the Internet, the ISO standards, OSI 7-layer model was a strong candidate of implementing network systems. But, the power of de facto standard and ecosystem which generates many applications continuously is significant. The Internet protocols have established the unswerving position finally.

In order to utilize the enormous resources of explosively growing Internet community, it is indispensable to use the Internet contents description language HTML (HyperText Markup Language), HTTP (HyperText Transfer Protocol), SSL (Secure Socket Layer) and so on. It was a severe technical challenge how to implement those specifications on mobile phones with small memory and low power CPUs.

### (2) Taking Leadership of de facto Standards

To define the specifications of the Internet, and promote the Internet, W3C (World Wide Web Consortium) was founded in 1994. HTML and related specifications were defined and progressed. In Japan, Keio University hosted liaison office in 1996, and started activity to increase Japanese members. ACCESS joined W3C, and proposed "Embedded WWW" for consumer appliances in June 1997. This was the first time for the author to propose publicly the necessity of "Compact HTML" for mobile phones (Fig. 2). A startup who were promoting HDML (Handheld Device Markup Language, later became the basis of

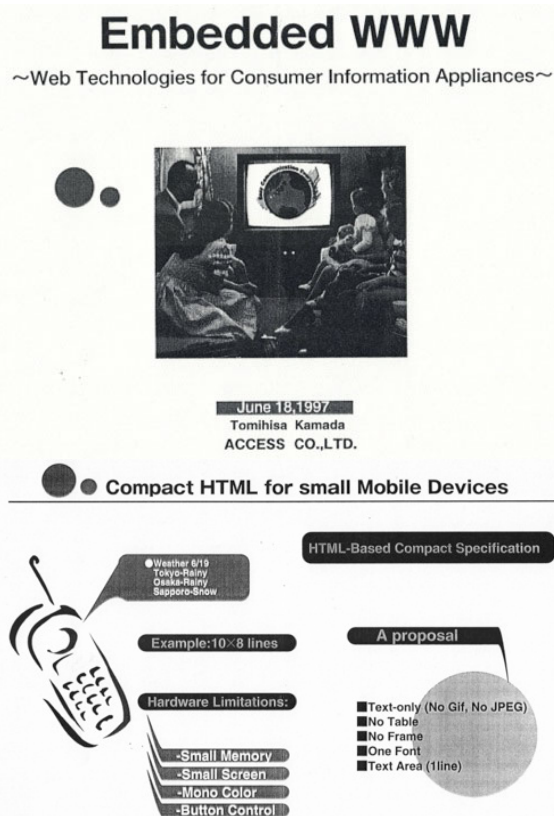

Fig. 2 Proposing "Embedded WWW" at W3C workshop.

WAP) was attending the same workshop. There were many discussions, but they were thinking that it was impossible to implement HTML on mobile phones at that time.

At the same time in 1997, we were proposing Web browser for mobile phones to NTT docomo. We started the trial project with NTT docomo, and defined the detail of specifications by taking a hard look at concrete contents services. This was not conceptual work on the desk, but realistic specifications which was designed for real commercial services for the next year. Then, the “Compact HTML” specification was submitted to W3C jointly by NEC, Panasonic, Fujitsu, Mitsubishi Electric, SONY and ACCESS, in Feb 1998 [2,3] (Fig. 3)

Since the specification becomes public, anybody can develop browser software based on that. For us, it is risky in a sense that any competitor will enter into this market. We thought it is very important to open up the specification and set priority on making market itself, in order to involve many players in new market of HTML contents for mobile phones.

In fact, several years before, we though the same thing when we developed Internet-TV. In that case, we started discussions with a US competitor about the common HTML specification for TV (TV-HTML). But, it was consuming long time, finally failed to reach an agreeable conclusion. Through that experience, this time, we decided to submit the specification first to the public in the world. It is second to adjust the friction if necessary. Compact HTML was the beginning for everyone in the wireless industry to start aware of Web services for mobile phones.

#### 4. Key Technologies of Mobile Web Browser

There were many technical challenges to implement Web browser on mobile phones [4]. There are several aspects different from the case of PC browser. Here we pick up major points, as follows.

##### (1) Unique Requirements from Mobile Phones

Though NetFront browser software had been deployed in many consumer devices including TVs, word processors, car navigation systems, game consoles, and PDAs, we had to solve severe constraints to implement it on mobile phones.

###### ● Phone-call first, Real-time processing

The most important function of mobile phone is “phone” function. This is the highest priority task that the system should handle. When an incoming call happens, the browser task should be immediately interrupted, and switched to the phone call task. Usually real-time operating system such as iTRON was used to handle real-time multi-task processing.

###### ● Fast boot

Fast boot of software is also important. It is not acceptable to take time like PC for booting the system. The execution program codes are not loaded into RAM, instead codes are stored in ROM and executed directly. And, the status is saved when the system is turned off, and restored in the next boot. When Linux became popular as the operating system of mobile phones, it was critical to realize quick boot of Linux system.

###### ● Small memory and low power CPUs

Mobile phones in 1997 had only very small hardware resources. The typical device in those days has 16-bit CPU (1-2 MHz) and 256 Kbytes memory. We had to design and implement the software to be as compact as possible by componentizing it and doing every effort to make it small.

###### ● Low power consumption

Another important requirement of mobile phone is battery life. For example, when browser is in the status of waiting for an event, we set the browser task in the sleep mode to save the power. Also, we collaborate with device makers to reduce the power consumption in total, by setting CPU to low-power mode depending on the situation, and by adjusting screen brightness.

##### (2) Local Web Applications

Browser is a language processor of programs written in HTML. We developed a smart mechanism to execute local Web applications (HTML programs) through the browser engine. It is difficult to store many applications within small memory. So, we had an idea to describe some applications, such as setting screen and email in HTML. Browser can handle those applications. In this case, we need only small additional memory. We extended “tag” features of HTML, and invoked local HTML.

This mechanism was very useful in the early days of mobile phones. We could reduce the application code size significantly by using browser engine to execute the applications. Today, it is common to describe applications in CSS and JavaScript. It was a cutting-edge idea 20 years ago [5].

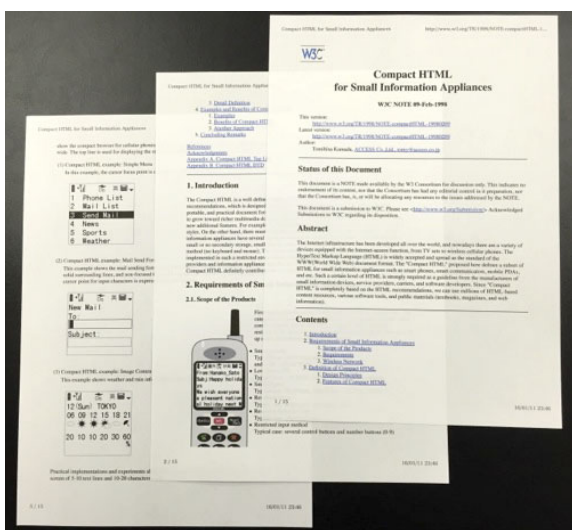

Fig. 3 Proposed “Compact HTML” to W3C.



(3) HTML extensions for Mobile Phones

Local Web mechanism is convenient to implement applications efficiently. In addition, contents described in Compact HTML can call local functions on mobile phones. For example, telephone number described in the HTML can invoke the phone call. Browser interprets an extended scheme “tel:” (or “phneto:”), then calls the phone function. Similarly, browser interprets “mailto:” scheme, and invokes the mail application.

Another extension is to handle input of key buttons on the devices. As the extension of “A tag” accesskey attributes, number key 1-9 can be assigned.

```
<A HREF="http: ..." accesskey="1"> 1. Home
```

In this example of HTML, when “1” key is pushed on the device, “1. Home” is selected. This accesskey feature was very common in mobile contents.

(4) Downloading Contents

In the contents services for mobile phones, it should be noted that the copyright protection of contents was realized, which was usually difficult for PC. The downloaded contents stored in the device were protected not to transfer outside. By such a robust mechanism, various contents services became successful, including ringer tones, photos, music, video, books, comics, and etc.

Also, wireless operators provided the billing system for contents provides. As a result, so many players have entered into mobile contents business.

5. Evolution of Mobile Web Browser

NTT docomo’s i-mode service was launched in Feb 1999. One million users joined in 6 months. One year after that, 10 million users joined already. It was amazing quick growth. Many contents providers were attracted, and the penetration of mobile phones was accelerated. Then, the number of i-mode users became 50 million, which was the almost all docomo’s users.

(1) Browser Evolution

We thought that flexible architecture of the browser software is important to extend the functions from the beginning. Though the scope of functionality was limited due to hardware constraints of mobile phones, it would be necessary to introduce, step by step, functions which were popular in the Internet. Especially, it might be necessary to support secure communication, SSL, and plug-in mechanism for extended contents. We developed the mobile browser software by taking such requirements into account.

Actually, as shown in Fig. 4, browser and mobile phone had been evolving, year by year. They were grown at the amazing pace, for 10 years started from 1999. We pick up major extended features below.

- Color screen (256, 4096, 24-bit 16M colors)
- Large screen (120x160, QVGA, VGA, ...)
- SSL support
- Java applications
- 3D engine
- Flash support
- PDF (Adobe Reader) support
- HTML mail
- TV function (ISDB-T, 1seg)

Based on Moore’s law, the performance of CPU becomes double in 18 months. This means that we can get better hardware with double performance at the same price. The size of software on mobile phone became 1,000 times larger for 10 years. During this period, the speed of mobile phone evolution outpaced that of Moore’s law.

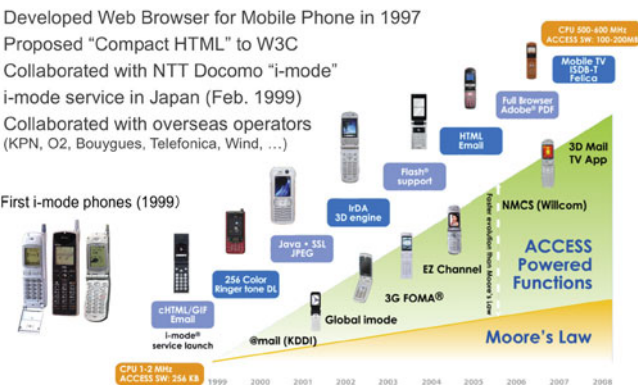

Fig. 4 Evolution of Mobile Web Browser.

(2) Architecture of Mobile Web Browser

Fig. 5 illustrates the architecture of browser software for mobile phones at those days. On the top of real-time OS, common libraries such as screen drawing and communication stacks are implemented. Various applications are built on those modules. Browser engine (NetFront Core) can be called from other applications as the HTML rendering engine. DRM (Digital Rights Management) handles the management

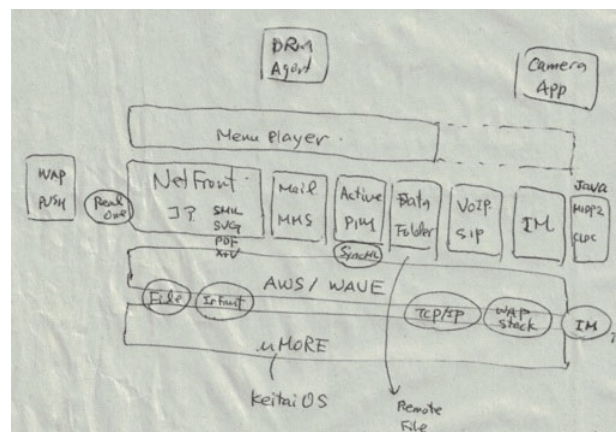

Fig. 5 Architecture of Mobile Web Browser (Sketch).

of downloaded contents. To support overseas' market requirements, WAP (Wireless Application Protocol) and MMS (Multimedia Messaging Service) are included. The whole system is an integrated software for network services, beyond browser software.

At the early stage, there were many different CPUs for mobile phones. In this sense, the portability of software was important to support a variety of CPUs. Gradually 32-bit RISC CPU has become popular. From mid-2000s, hardware had obtained enough power to execute Linux. CPU supported MMU (Memory Management Unit), then virtual memory function was supported on mobile phones.

(3) Difficulty of Testing and Validation

As mobile phones become to have many functions such as browser, email, Java, Flash, and so on, the quality control and test becomes difficult dramatically. Phone service is traditionally regarded as guarantee service. It is never disconnected because of heavy traffic. On the other hand, the Internet itself is designed on the best effort basis. Because the Internet traffic is always changing, it could not be guaranteed. So, the design policy is essentially different between phone service and Internet service.

Especially, connecting to the open Internet, it is impossible to know which HTML contents and Java applications are coming in advance. In such an open and dynamic environment, it can be said that it is impossible to test the software for 100% cases.

It was a big challenge in the aspect of testing and product validation, when such a new function of the Internet was embedded in the mobile phones. Actually, sometimes problems happened in the wireless industry. Huge amount of human resources were allocated for testing in those days. Also, automatic testing tools and devices were developed.

ACCESS developed simulation software (viewer software for mobile phone contents) on PC. Contents providers can check their contents in advance on PC by using this tool [6].

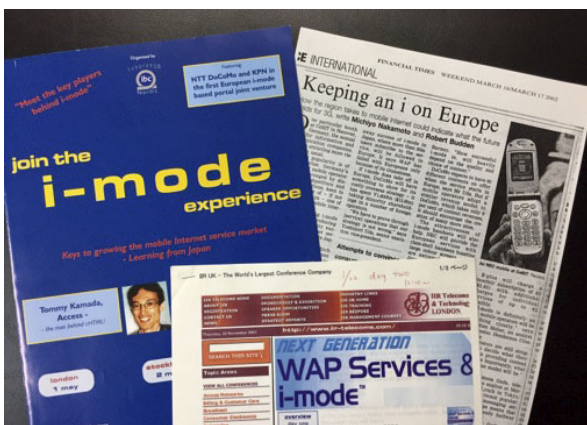

Fig. 6 i-mode in Overseas Market.

6. Global Development

HTML-based contents services for mobile phones started from Japan. At the same time, in overseas market, WAP-based services have started, which is optimized for wireless, instead of using HTML and the Internet standards. They were struggling with lack of mobile contents, because it was challenging to let contents providers make new WAP contents. At that time, since i-mode was successful in Japan, “i-mode vs WAP” was often picked up and paid great attentions at the international conferences and events in wireless industry [7] (Fig. 6).

ACCESS supported NTT docomo to deploy i-mode service to overseas market. Also we developed browser to support WAP contents besides HTML contents. Overseas operators which already started WAP-based service can upgrade their services to cover HTML-based contents as well as WAP contents by using this solution (Fig. 7).

We partnered with Nokia, Samsung, and LG who have market share in overseas market, and provided our browser to them. The service was not so successful, partly because overseas wireless infrastructure was not so matured at that time. We were leading the industry, starting from Japan.

ACCESS' browser software NetFront has been deployed in many mobile phones for Japanese market and overseas market. In total, more than 1 billion devices have been shipped with NetFront. It became an example of global success of embedded software.

7. Concluding Remarks

It was exciting to make innovative “Mobile Internet” which was the first breakthrough in the world, starting from 1999 in Japan [8-10]. Wireless operators, mobile phone makers, contents providers and software vendors collaborated together with strong passion to create a new industry. In fact, it became a big business. During this period, big companies worked with many startups. For startup companies had good opportunities to grow. I think it was also a good example where cooperation between big companies and startups accelerated the

Compact NetFront Plus for GPRS Network

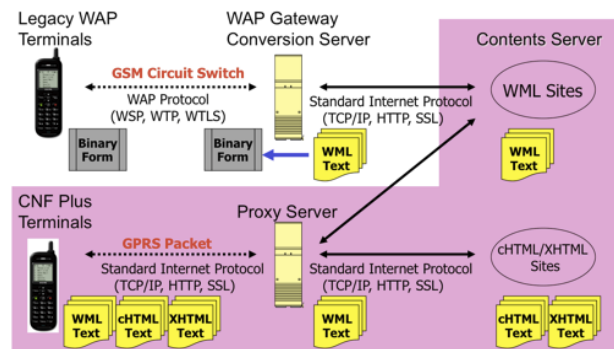

Fig. 7 Solution to support overseas WAP.



innovation. I was very impressed by being deeply involved in this historic movement. And I appreciated greatly of support and help from all people, and members of ACCESS, who worked hard together for the challenging projects.

Though it is regrettable that US giants got the leadership position for the following smartphone generation, the winners are changing all the time. For Japanese companies, we hope to apply our experienced success model, in which the combination of hardware and software creates the platform for advanced services, for the next generation. Japan is strong and competitive in the areas of IoT, robotics, medical and life science. I am expecting that collaboration between big companies and startups brings innovation to create a new industry in future [11].

## 8. References

- [1] T. Arakawa and T. Kamada, “The Internet Home Electronics and the Information Network Revolution”, Technical Report of IEICE, OFS96-1, pp.1-6, May 1996. (Japanese).
- [2] T. Kamada, “Compact HTML for small information appliances”, W3C Note, Feb. 1998.
- [3] T. Kamada, T. Asada, M. Ishikawa, and S. Matsui, “HTML 4.0 guidelines for mobile access”, W3C Note, Mar. 1999.
- [4] T. Kamada, “Key Enabling Technologies for Net Appliances and Ubiquitous Networking”, J. IEICE, vol.85, no.5, pp.355-362, May 2002. (Japanese).
- [5] D. F. Zucker, M. Uematsu, and T. Kamada, “Content and web services converge: a unified user interface”, IEEE Pervasive Computing, vol.4, no.4, pp.8-11, Oct. 2005.
- [6] T. Kamada, “How To Create i-mode Homepages, Compact HTML and Mobile Internet”, C-Media, 2000. (Japanese).
- [7] S. J. Barnes and S. L. Huff, “Rising sun: iMode and the wireless internet”, Comm. of ACM, vol.46, no.11, pp.79-84, Nov. 2003.
- [8] Keiichi Enoki, “Tamer of i-mode Animals”, Kodansha, 2015. (Japanese).
- [9] “i-mode Development Story”, Nikkei Electronics Magazine, Nikkei BP, Aug. 2002 – Feb. 2003. (Japanese).
- [10] Nik Frengle, “i-mode: A Primer”, Wiley, 2001.
- [11] T. Kamada, “Tech Startups and Entrepreneurs Create the Future”, Univ. of Tokyo Press, 2017. (Japanese).

# A Foreign Researcher's Journey in Japan: From Bangladesh to UEC and NICT

Abu Hena Al Muktadir

National Institute of Information and Communications Technology



## 1. Introduction

A decade has passed since I first arrived in Japan on 1<sup>st</sup> October 2009 as a Monbukagakusho (MEXT) Scholarship student to pursue a Ph.D. at the University of Electro-Communications (UEC). Since November 2014, I have been working as a Researcher at The National Institute of Information and Communications Technology (NICT). This article briefly introduces the experiences I have achieved during the past ten years studying and working in Japan.

## 2. Childhood Ambition to Visit Japan

I was born and brought up in Bangladesh. I remember that in my childhood, my parents owned three made in Japan products, a National television, a Sony audio cassette player, and a Honda motorcycle. My parents used to tell me that Japan produces the best electronics products in the world. So, from early childhood, it was my dream to visit Japan one day. The wish came true when I received the MEXT scholarship offer in 2009. I completed the B.Sc. (Honors) and M.Sc. degrees in Information and Communication Engineering (ICE) from the University of Rajshahi, Bangladesh, in 2004 and 2005, respectively. Before coming to Japan, I served as a full-time Lecturer at Daffodil International University, Bangladesh.

## 3. Ph.D. Journey at UEC

I joined the Oki Laboratory of UEC under the supervision of Prof. Eiji Oki. I did not know the Japanese language, so I was a bit worried in the beginning. However, my supervisor Prof. Oki was fluent in speaking English, and our lab had many international students. So, English was the primary language for communication and research in the lab. I joined the Japanese language class offered by UEC. The classes were very interesting, and I made many friends and learned conversational level Japanese within few months, which eased my daily life.

My Ph.D. research topic addressed one significant concern of “Should we use the network coding technique in the design of reliable communication networks?” It is necessary to have an idea of how much resource saving is possible if a network coding technique is used for reliable route design for communication networks. The amount of resource saving creates interest for the investors and researchers in communication community to use coding techniques

in network design. In my thesis, I addressed the coding based route design problems to find the amount of resource saving achieved by using the network coding technique with protection techniques [1].

During my Ph.D. studies, I learned a lot of new theories and techniques with the proper and careful guidance of Prof. Oki. In particular, I learned mathematical optimization techniques and their application to solving routing problems in the computer network. For such a topic, I was awarded the best paper award from the TriSai symposium, 2012. A photograph of the award ceremony is shown in Fig. 1. I completed all the requirements and was awarded the Ph.D. degree in September 2014.

I had the opportunity to travel to Kyoto, Ise, and Nagano Ski resort organized by UEC. I also enjoyed the MIFO tea party, hosted every Thursday afternoon at UEC by Japanese volunteers, where I obtained opportunities to discuss and learn many things about Japanese traditions and cultures.



Fig. 1 The Best Paper Award in the 7<sup>th</sup> Triangle Symposium on Advanced ICT (TriSAI 2012) in September 2012.



Fig. 2 The English Session Award by IEICE Network System Committee in October 2018.

#### 4. Research Activities at NICT

At NICT, I belong to the Network Science and Convergence Device Technology Laboratory, which is under the Network System Research Institute located at the NICT Headquarters in Tokyo.

Our laboratory conducts research on new network architecture and critical enabling technologies to realize innovative networks able to support a myriad of future Internet of Things (IoT) services as well as applications that are aligned with the rapidly evolving cloud technology. In particular, the lab pursues research on technologies for (i) automation of dynamic, on-demand network configuration and control, (ii) information dissemination and sharing based on information-centric networking concepts.

I am a member of the “Network Automation” research team. My research focuses on the automation of heterogeneous network control, resource allocation, and arbitration among multiple service networks to build and manage the heterogeneous network by low cost. We assume the existence of diverse services that have different characteristics, such as very low latency, guaranteed bandwidth and time-variant traffic. My three research achievements, for example, are described briefly below:

- **Internet route control with BGP:** We proposed route advertisement policies (RAP) and an Inbound Traffic Engineering (ITE) technique to control the direction of inbound traffic into a multihomed autonomous system (AS) employing the BGP protocol and hierarchical provider aggregatable (PA) addressing [2]. By applying our proposed RAP and ITE technique, ASes are benefitted by the reduction of routing information to be exchanged and flexible inbound control. We also clarified that ASes have to weaken their failure recovery function in some cases. Experiments in an emulation environment (with global PA address deployment and no tier-2 peering) confirmed that the proposed RAP with BGP-HANA reduces the overall FIB and RIB sizes by 73.43% and 73.19%, respectively and the number of BGP update messages exchanged by up to 69.9% compared to conventional BGP RAP.
- **Multi-target classification based automatic resource allocation:** We propose a method for automatic virtual resource allocation by using a multi-target classification-based scheme (MTCAS) [3]. In our approach, an Infrastructure Provider (InP) bundles its CPU, memory, storage, and bandwidth resources as Network Elements (NEs) and categorizes them into several types in accordance with their function, capabilities, location, energy consumption, price, etc. MTCAS is used by the InP to optimally allocate a set of NEs to a Virtual Network Operator (VNO). Such NEs are subject to some constraints, such as the avoidance of resource over-allocation and the

satisfaction of multiple Quality of Service (QoS) metrics. The results also demonstrate that increasing the amount of training data increases the efficacy of MTCAS, thus reducing CPU and memory allocation by about 33% and 51%, respectively.

- **Game theory-based resource negotiation:** We modeled virtual resource negotiation among InP and several incumbent VNOs in a limited resource availability situation by using a repeated game [4]. At each negotiation iteration of the repeated game, InP adopts one of our proposed three strategies, focusing on utility increases of InP, preferences of the incumbent and new VNOs, and previous negotiation histories, respectively. We numerically evaluated improvements in the utilities for InP and VNOs that have been provided by our proposed three strategies and compared them against the two conventional strategies. We observed that by serving new requests and by using the proposed strategy 1, the utility of InP increases by up to 21%, which is up to 5% higher than that of conventional strategies.

#### 5. Involvement with IEICE

I have published several journals and volunteered as a reviewer for IEICE transactions. Besides, I regularly attend conferences and workshops organized by the IEICE Communication Society. I have received “The English Session Award” by IEICE Network System Committee in October 2018 (Fig. 2)

#### 6. Acknowledgments

I want to thank the editor of the IEICE-CS Global Newsletter for this writing opportunity. I also take this opportunity to express my sincere gratitude to my supervisor Prof. Eiji Oki, the colleagues at NICT, my family here to make my ten years journey eventful, enjoyable, and full of learnings.

#### 7. References

- [1] A. H. A. Muktadir *et al.*, “Optimum Route Design in 1+1 Protection with Network Coding for Instantaneous Recovery,” *IEICE Trans. Commun.*, Vol. E97-B, No. 1, pp. 87-104, Jan. 2014.
- [2] A. H. A. Muktadir *et al.*, “Route Advertisement Policies and Inbound Traffic Engineering for Border Gateway Protocol with Provider Aggregatable Addressing,” *IEICE Trans. Commun.*, Vol. E101-B, No. 6, pp. 1411-1426, Jun. 2018.
- [3] A. H. A. Muktadir *et al.*, “Multi-Target Classification Based Automatic Virtual Resource Allocation Scheme,” *IEICE Trans. Inf. and Systems*, Vol. E102-D, No.5, pp. 898-909, May 2019.
- [4] A. H. A. Muktadir *et al.*, “Repeated Leader-Follower Game for Managing Cloud Networks With Limited Resources,” *IEEE Access*, Vol. 7, No. 1, pp. 108174-108188, Dec. 2019.



# Report on Communications Society Special Talk and Awarding Ceremony at 2019 IEICE Society Conference

Toru Takahashi, Takahiko Saba  
 Directors of General Affairs, IEICE Communications Society



## 1. Introduction

IEICE Communications Society awards people who have made a great contribution to the Society every year at the IEICE Society Conference. In this article, we report an overview of the Communications Society Special Talk and Awarding Ceremony held at Osaka University, Osaka, Japan on September 11, 2019.

In the awarding ceremony, Prof. Tomoaki Ohtsuki, President of the IEICE Communications Society, presented two awards: The Outstanding Contributions Award and the Distinguished Contributions Award.

In the special talk, we have offered various topics every year. This year, we set up a lecture by Prof. Keishin Sasaki, President & CEO of e-solutions, Inc. as well as a visiting professor of Keio University. The title of the talk was “Solving Social Issues through Innovations - Early Detection of Disease at home- .”



Fig. 1 Participants at the Special Talk and Awarding Ceremony at the 2019 IEICE Society Conference.

## 2. Opening Address

Prior to the awarding ceremony, Prof. Tomoaki Ohtsuki, President of the IEICE Communications Society, gave opening address. He introduced some special sessions and activities in the conference, and he thanked the contributions of the people in the venue. He concluded his address with his congratulations to the awardees.



Fig. 2 Prof. Tomoaki Ohtsuki, President of the IEICE Communications Society, gave opening address.

## 3. Awarding Ceremony

The Outstanding Contributions Award was given to the ex-Editor-in-Chiefs of *IEICE Transactions on Communications (Japanese Edition)*, and the ex-Representatives of sixteen Technical Committees, respectively.

The Distinguished Contributions Award was given to

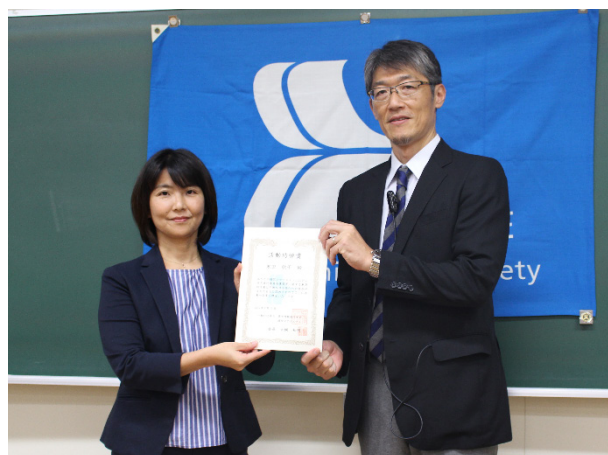

Fig. 3 Outstanding Contributions Award presented by Prof. Tomoaki Ohtsuki.



Fig. 4 Assist. Prof. Nattapong Kitsuwon acknowledged on behalf of the awardees.



Fig. 5 Special talk by Prof. Keishin Sasaki from e-solutions, Inc.

those who has largely contributed to managing, planning, and editing activities in the Communications Society, and peer reviewing of a number of papers. This year, 121 members were awarded for their significant contributions to the Communications Society until 2018. At the end of the ceremony, Assistant Prof. Nattapong Kitsuwon of The University of Electro-Communications expressed his gratitude as a representative of the awardees.

#### 4. Special Talk

After the awarding ceremony, Prof. Keishin Sasaki, President & CEO of e-solutions, Inc. was introduced as a speaker of the Special Talk. The title of the special talk was “Solving Social Issues through Innovations - Early Detection of Disease at home-.”

At the beginning of the talk, he introduced some statistics: how many people in Japan will be elderly and how many will suffer from serious diseases such as stroke and myocardial infarction in the future. Through these statistics, he emphasized the importance of detecting such diseases at home and treating the patient immediately. He also introduced that AIST estimates that if a stroke is detected early, the economic loss of 1 trillion JPY can be reduced.

Then, he introduced an innovative R&D project that is developing the world's first in house “Early Detection system”. The system includes a variety of remote features such as patient monitoring, patient abnormality notification, two-way telecommunications, and emergency ambulance automatic requests. He stated that this innovative project is being promoted through industry-academia collaboration. He concluded his talk by saying that this kind of innovative activities could not only solve various social problems but also promote sustainable growth in both academic and industrial points of view, and he encouraged the listener on their own innovations.

#### 5. Conclusions

In this article, we reported the IEICE Communications Society Special Talk and Awarding Ceremony. Communications Society Special Talk and Awarding Ceremony ended with closing address by Prof. Nobuyoshi Kikuma, President-Elect of the Communications Society. He emphasized that it is important for the Communications Society to activate interdisciplinary activities in the future. IEICE Communications Society will continue to support members’ activities in various fields.

# Report on ICM English Session at 2019 IEICE Society Conference – BS-4, Network and Service Design, Control and Management –

Noriaki Kamiyama  
Session Organizer, Fukuoka University



## 1. Introduction

The 2019 IEICE Society Conference was held at Osaka University in Osaka, on September 10-13, 2019, where three Societies of Engineering Sciences Society (ESS), Communications Society (CS), and Electronics Society (ES) joined.

In the Conference, the IEICE Technical Committee on Information Communication Management (ICM) [1] hosted a full English Session entitled “Network and Service Design, Control and Management” as one of 6 Symposium Sessions which focused on special topics of advanced technologies.

## 2. Background of ICM English Session

ICM has been hosting English session every year since 2004. The purpose of this English session is to contribute to the globalization of IEICE by offering the chance of the presentation and discussion in English to the foreign researchers/students living in Japan and the overseas researchers/students.

Figure 1 shows the change in the number of contribution papers since 2004. When the session began in 2004, only 15 papers were submitted. Since then, the number of papers has gradually increased and it reached 55 papers in 2013. Although it decreased in these years, it keeps over 30 after 2008.

The holding period of the session in the 2004 was one and half days, and that in this year was 3 days.

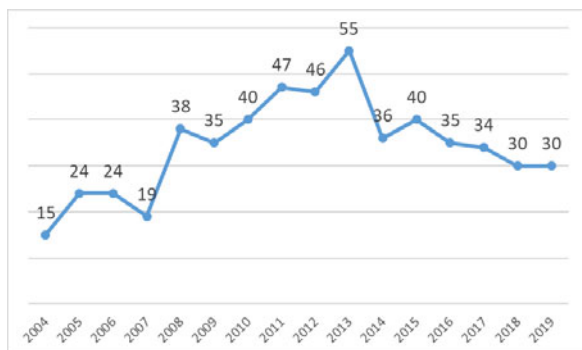

Fig. 1 The number of contribution papers since 2004.

## 3. Presentations in ICM English Session

The contribution papers were classified into 8 sub-sessions according to the topics. Various topics are discussed in each sub-session every year.

Figure 2 shows the number of papers corresponding to their topics. Relatively many papers related to Wi-Fi network, machine learning (ML)/data analytics, IoT, and ICN (information-centric networking) were presented.

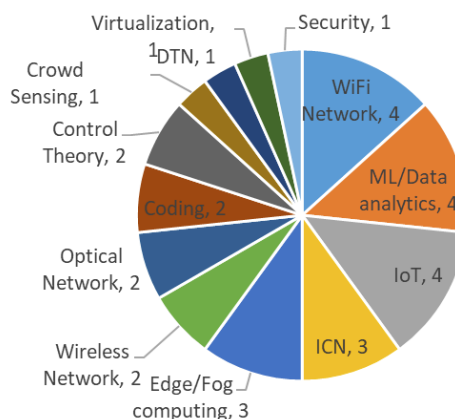

Fig. 2 The number of contribution papers corresponding to their topics.

## 4. Authors

Figure 3 shows the number of papers corresponding to the categorization of the presenter's affiliations. 87% of the speakers belonged to the university, and remained 13% belongs to the industries and national institute. The situation in which the contribution from the university occupied the majority did not change.

Although most of speakers were international students studying in Japan, 10 presenters were Japanese students or researchers. In this symposium, ICM expects the open contribution from not only the university but also enterprise, and expects the various presenters from not only the international students and the foreign researchers but also Japanese students and researchers, too.



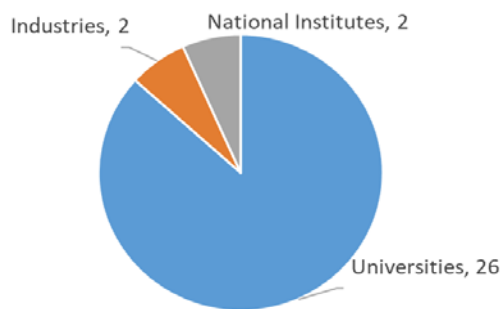

Fig. 3 The number of papers corresponding to the categorization of the speaker's affiliations.

Every speaker and audience enthusiastically discussed the ideas and opinions in the time assigned for question and answer. Since the assigned time passed quickly, some speakers and questioners continued their discussion here and there even into the break time.

### 5. Award of ICM English Session

ICM will select the best papers and award a prize of the session in the near future to encourage their continuous activities. The best papers will be awarded in the upcoming ICM workshop in March 2019.

Table 1 shows the awarded papers presented in the 2019 IEICE Society Conference in March this year [2,3]. Its awarding ceremony took place in the last ICM workshop (Fig. 4).

### 6. Conclusions

ICM English session in 2019 successfully finished with a lot of excellent presentations and a very active discussion. The organizer believes that this session became fruitful for all people and was able to contribute to the globalization of IEICE. He wishes that more papers will be contributed to the session in the next year.

Table 1 English session Awardees of ICM Committee

<b>Awardees:</b> Ping Du, Akihiro Nakao (The Univ. of Tokyo)
<b>Title:</b> Towards Application Specific RAN Slicing Through In-Network Deep Learning
<b>Awardees:</b> Kazuyuki Yamashita, Yuichi Yasuda, Ryo Nakamura, Hiroyuki Ohsaki (Kwansei Gakuin Univ.)
<b>Title:</b> A Study on Robustness of Complex Networks against Non-Adversely Node Removals



Fig. 4 Winner of ICM English session award.

### 7. Acknowledgement

The organizer would like to thank Prof. Yoshiaki Tanaka at Waseda University, who made a great contribution in soliciting papers, utilizing his nationwide academic authority and human relations. He would also like to thank all the member of the ICM committee, the attendees and everyone who contributed to the discussions and supported the session.

### 8. References

- [1] IEICE ICM Technical Committee web site, <http://www.ieice.org/~icm/eng/>
- [2] Ping Du, Akihiro Nakao, "Towards Application Specific RAN Slicing Through In-Network Deep Learning," 2018 IEICE Society Conference, BS-7-6, September 2018.
- [3] Kazuyuki Yamashita, Yuichi Yasuda, Ryo Nakamura, Hiroyuki Ohsaki, "A Study on Robustness of Complex Networks against Non-Adversely Node Removals," 2019 IEICE Society Conference, BS-7-3, September 2019.

## Activities of Technical Committee on Optical Fiber Technologies (OFT)



Hajime Arai\* and Hiroshi Watanabe\*\*  
Sumitomo Electric Industries, Ltd.\* , NTT\*\*  
URL: <https://www.ieice.org/~oft/jpn/english.html>



### 1. Introduction

The Optical Fiber Technologies (OFT) committee, which was established in April 1998, is one of the technical committees of the Communications Society of the IEICE. One of the most important aims of our committee is to contribute to technological innovation in relation to optical fiber technologies for the development of industrial applications. We do this by focusing on the technologies from cross-sector viewpoints with reference to communication engineering, measurement technologies, optical devices, and materials. When OFT committee was established, optical fiber was applied in practical use. Since then, there is a great interest in optical fiber application such as sensing, signal processing, energy transport and the progress in the study is expected in the future.

Our topics of interest mainly include optical fiber sensing, optical fiber devices, optical fiber systems, optical fiber wiring/installation, maintenance/operation, and the design of optical fiber/cables. We discuss optical devices that are applied to actual communication equipment. OFT covers research areas ranging from basic optical technology to actual maintenance.

### 2. OFT Activities in FY 2018

#### 2.1 Technical Meeting

We hold one- or two-day technical meetings six times a year. Many researchers participate in the meetings, and they report their latest results. The schedule in FY 2018, which consists of six regular technical meetings, is shown in Table 1. Three meetings are co-organized with other committees and there were wide range of presentations including optical communication, broadcasting, optoelectronics and laser. Seventy-eight papers were presented at our regular meetings in FY 2018.

#### 2.2 Special Events of OFT in FY 2018

We also held a tour of Tanegashima space center, which is the largest space development center in Japan, as a special event in the 5<sup>th</sup> technical meeting in Tanegashima. The participants of this tour were excited because they could see the huge facilities that we cannot usually see. In the technical session, we had two invited talks related to space developing. We can learn the examples of optical fiber technology which could be applied to space development.

Table 1 Technical meetings schedule for FY 2018

Date	Venue	Joint committee
2018 5/18	The Kikai Shinko Kaikan Building (Tokyo)	
2018 8/30-31	Hakodate Hokuyo Building (Hakodate)	OCS, LSJ
2018 10/11-12	Tohoku Univ. (Sendai)	
2018 11/8-9	Kurashiki Art & Cultural Hall (Kurashiki)	IEE-CMN, ITE-BCT, OCS
2019 1/17-18	Nishinoomote City Hall (Nishinoomote)	
2019 2/14-15	Dai-Hakata Building (Fukuoka)	OPE, OCS

#### 2.3 Poster Session for Students

We held the poster session for students in the 3<sup>rd</sup> technical meeting (Tohoku Univ.). The aim is to hold a meeting for students to present easily and to enhance the discussion between students. There were thirty-eight presentations, which is 2.5 times more than last year. This session got a good reputation from presenters and audiences and we also held it in May 2019.



Fig. 1 Student poster session.

#### 2.4 OFT Encouragement Award in 2018

Since the program was launched in 2011, OFT has encouraged the research activities of younger researchers. This program has two awards for younger researchers and students. The winners of the Young Researcher Award were Yuto Sagae (NTT) and Kohei Kawasaki (Furukawa Electric) who both presented papers [1,2]. The winners of the Young Researcher Award for Students were Takuya Fujimoto (Mie Univ.),

Koki Ono (Osaka Prefecture Univ.), Ryo Ishikawa (Tokyo Tech) and Daisuke Kamiyama (UEC) who also presented papers [3-6].

## 2.5 Activities of IEICE Society and General Conferences

Sixty papers were presented at the IEICE Society and General Conferences in FY 2018. We organized the symposium “Latest trend of optical measurement - Progress of measurement technology based on high-precision and high-speed processing -” on 11<sup>th</sup> September at the IEICE Society Conference 2018 (September 11<sup>th</sup>-14<sup>th</sup>, 2018, Kanazawa Univ., Kanazawa). Seven outstanding speakers were invited, and they gave talks on topics about optical measurement application. Another symposium, “IoT and optical fiber sensing technology” was organized on 19<sup>th</sup> March at the IEICE General Conference 2019 (March 19<sup>th</sup>-22<sup>nd</sup> 2019, Waseda Univ., Tokyo). There were nine invited talks and the directionality of optical fiber sensing for IoT was discussed.

## 2.6 The 20 Year Anniversary Symposium

In 2018 it was 20<sup>th</sup> anniversary of the establishment of OFT committee. We held the anniversary symposium and there are 84 attendees. In the symposium, we had invited talks by three fellows of IEICE related to OFT. Technical lectures were also given by experts on six themes closely related to OFT.



Fig. 2 Attendees of 20-year anniversary symposium.

## 3. Technical Meetings in FY 2019

We plan to hold six successive technical meetings as shown in Fig.3. The 5<sup>th</sup> technical meeting in next January is going to be held in Okazaki and we are planning a tour of car factory. We would welcome your submissions to and/or participation in our conferences (<https://www.ieice.org/~oft/jpn/english.html>).

## 4. Conclusion

This report has summarized the activities of the Technical Committee on Optical Fiber Technologies. To conclude, we would like to thank all the speakers and participants for their contributions.

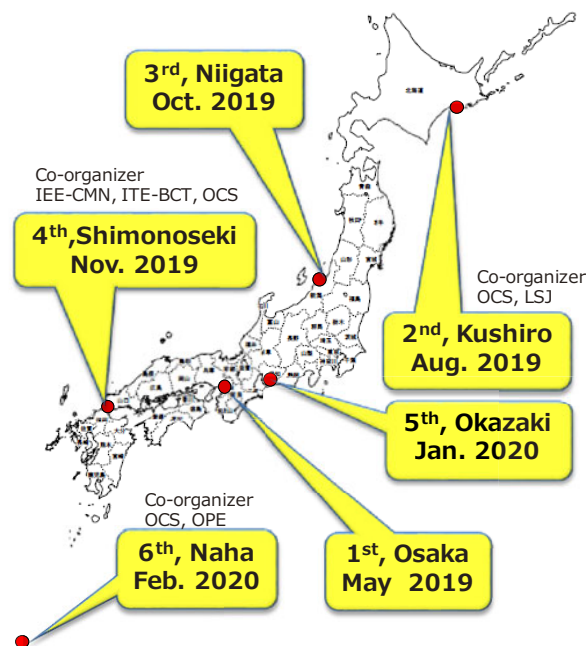

Fig. 3 Regular technical meetings in FY 2019.

## 5. References

- [1] Yuto Sagae, et al, “A Study of Solid Type Low Latency Optical Fiber,” IEICE Tech. Rep., vol.118, no.40, OFT2018-2, pp.5-10, May 2018.
- [2] Kohei Kawasaki, et al, “Properties improvement of MT type 8-fiber connector for 125  $\mu$ m cladding MCF,” IEICE Tech. Rep., vol.118, no.40, OFT2018-4, pp.17-20, May 2018.
- [3] Takuya Fujimoto, et al, “Noise reduction of Brillouin gain spectrum using non-negative matrix factorization,” IEICE Tech. Rep., vol.117, no.387, OFT2017-64, pp.37-41, Jan. 2018.
- [4] Koki Ono, et al, “Dependence of nonlinear signal degradation on baud rate and frequency interval in Nyquist OTDM-WDM transmission,” IEICE Tech. Rep., vol.118, no.289, OFT2018-55, pp.15-18, Nov. 2018.
- [5] Ryo Ishikawa, et al, “Optical wavelength dependence of strain sensitivity of FBG inscribed in perfluorinated plastic optical fibers,” IEICE Tech. Rep., vol.117, no.434, OFT2017-72, pp.17-22, Feb. 2018.
- [6] Daisuke Kamiyama, et al, “Multichannel data signals and power transmission using a double-clad fiber,” IEICE Tech. Rep., vol.118, no.202, OFT2018-7, pp.5-9, Aug. 2018.



# Report on the 2<sup>nd</sup> Indonesia-Japan Workshop on Antennas and Wireless Technology (IJAWT2019) and the 2019 Malaysia-Japan Workshop on Radio Technology (MJWRT2019)

Hiroaki Nakabayashi  
Chiba Institute of Technology



## 1. Introduction

Indonesia-Japan Workshop on Antennas and Wireless Technology (IJAWT2019) was the 2<sup>nd</sup> workshop on antenna, propagation and wireless technologies between Indonesia and Japan. This workshop was held on July 29-30, 2019 in Bandung. The IJAWT2019 was intended to provide an international forum for the exchange of information on the progress of research and development in antennas, propagation, RF/microwave and wireless communication systems. It was also an important objective of this workshop to enhance the friendship between Indonesian and Japanese researchers. The IJAWT2019 was sponsored and organized by IEEE AP-S/MTT-S Joint Chapter Indonesia Section with technical cooperation from the Technical Committee on Antennas and Propagation of the IEICE [1].

Malaysia-Japan Workshop on Radio Technology 2019 (MJWRT2019) was the third workshop on radio technology between Malaysia and Japan. The MJWRT2019 was sponsored and organized by the Technical Committee on Antennas and Propagation of the Institute of Electronics, Information and Communication Engineers (IEICE/AP), co-sponsored by the IEEE AP/MTT/EMC Malaysia chapter and Malaysia-Japan International Institute of Technology Universiti Teknologi Malaysia (MJIT-UTM), and was held in cooperation with the IEEE AP-S Tokyo Chapter. This workshop was held on August 1-2 of the same week as the IJAWT2019 at Hotel Istana, Kuala Lumpur. The workshop was intended to provide an international forum for the exchange of information on the progress of research and development in antennas, propagation, RF and radio communication systems. It was also an important objective of this workshop to enhance the friendship between Malaysian and Japanese researchers [2].

## 2. History of IJAWT and MJWRT

Technical committee on antennas and propagation has performed some conferences in Asian countries like Indonesia and Malaysia since 2014. The first IJAWT, IJAWT2017, was held in Depok, Indonesia, on December 18, 2017, and the venue was Universitas Indonesia. The IJAWT2019 was the second IJAWT, was held at Sawunggaling Hotel in Bandung, Indonesia.

On the other hand, the first MJWRT, MJWRT2015, was held in Kuala Lumpur, Malaysia, on June 15, 2015. Thereafter, the second MJWRT, MJWRT2017, was held in the same Kuala Lumpur, Malaysia, during January 26-27, 2017. The both venues were Malaysia-Japan International Institute of Technology (MJIT). The MJWRT2019 was the third MJWRT, was held at Hotel Istana in Kuala Lumpur, Malaysia.



Fig. 1 Opening ceremony (IJAWT2019).



Fig. 2 Oral session (IJAWT2019).



Fig. 3 Poster session (IJAWT2019).



Fig. 4 Opening ceremony (MJWRT2019).



Fig. 5 Oral session (MJWRT2019).



Fig. 6 Listeners (MJWRT2019).



Fig. 7 All participants (IJAWT2019).

The each conference has been held every two years in each country. In the future, IJAWT and MJWRT will also be held in the every two years.

### 3. Conference Overview

The IJAWT2019 was held in two days, and an opening ceremony, four oral sessions, a poster session, and dinner were carried out on the first day. Two oral sessions and a closing ceremony were carried out on the second day. The technical program of IJAWT2019 consisted of four invited speaks, 14 general oral speaks, and 33 student poster speaks. The number of the participants was large from Indonesia and 17 from Japan. Figure 1, 2, and 3 show the opening ceremony, the oral session, and the poster session in IJAWT2019, respectively.

The MJWRT2019 was also held in two days, and an opening ceremony, two keynote sessions, a tutorial session, three general oral sessions, an industry session, and banquet were carried out on the first day. A keynote session, two oral sessions, two industry sessions, and a closing ceremony were carried out on the second day. The technical program of MJWRT2019 consisted of three invited speaks, a tutorial speech, 26 general oral speaks, and three industry speaks. The number of the participants was large from Malaysia and 20 from Japan, and all the participants exchanged active arguments and information. Figure 4, 5, and 6 show the opening ceremony, the oral session, and the listeners in the MJWRT2019, respectively. In addition, Fig. 7 and 8 show the all participants of each conference.

### 4. Award

The IJAWT2019 and the MJWRT2019 established Presentation or Paper Award on the student papers.





Fig. 8 All participants (MJWRT2019).



Fig. 9 Banquet (MJWRT2019).

Following five papers were awarded on the IJAWT2019.

1. "Multi-Band Reconfigurable Low-Profile Monopole Antennas with Independent Tunability," K. Paramaydha, S. J. Chen, T. Kaufmann, W. Withayachumnankul, and C. Fumeaux.
2. "Influence of Circuit Ground on Transmission Efficiency of Magnetic Material Loaded Small Solenoid for Near Field Communications Installed into Mobile Terminals," Y. Nakamura, K. Cho, and H. Nakabayashi.
3. "Bandwidth and Gain Improvement Using Artificial Magneto-Dielectric Material with Split-Ring Resonator Array Configuration," Y. G. Adhiyoga, C. Apriono, and E. T. Rahardjo.
4. "Power Weighted Linear Array Antennas Based on Blackman and Kaiser Function," H. Mistialustina, Chairunnisa, and A. Munir.
5. "Design of Millimeter-Wave 4x4 Butler Matrix Using Finline in Double Layer Dielectric Substrate," N. T. Tuan, K. Sakakibara, and N. Kikuma.





Fig. 10 Cultural exchange (MJWRT2019).

Following three papers were awarded on the MJWRT2019.

1. “Aperture Coupled Wideband Dielectric Resonator Antenna Using L-Strip Feed,” I. Ali, M. H. Jamaluddin, and A. Gaya.
2. “Broadside Beam-Forming Performance of Two-Dimensional Rotman-Lens Multi-Beam Antenna Using Step Radiating Elements on Multi-Layer Substrate Integrated Waveguide,” S. Yamauchi, K. Yamada, K. Sakakibara, N. Kikuma, K. Iwasa, T. Okunaga, and A. Nakatsu.
3. “A Compact Dual Negative LC Resonator Loaded Metamaterial Inspired Antenna for 5G Technology,” M. M. Rahman, M. S. Islam, H. Y. Wong, S. S. Al-Bawri, and M. T. Islam.

We hope to report excellent studies for the prize winners in the future.

### 5. Dinner and Banquet

At the first night of the conferences, the dinner or the banquet was held at the restaurant or the room of the hotels where the conferences were held. All participants enjoyed the delicious country foods, beverage, and cultural exchange (Fig. 9 and 10).

### 6. Conclusion

The steering committee of the IJAWT2019 and the MJWRT2019 thanks to all participants and people related the conferences. I believe that all participants were satisfied with the conferences. I look forward to meeting many researchers in next IJAWT and MJWRT.

### 7. References

- [1] Website of IJAWT2019, IEICE Technical Committee on Antennas and Propagation, <https://www.ieice.org/cs/ap/jpn/index.php?ijawt/ijawt2019>
- [2] Website of MJWRT2019, IEICE Technical Committee on Antennas and Propagation, [https://www.ieice.org/~ap\\_ac/jpn/index.php?mjwrt/mjwrt2019](https://www.ieice.org/~ap_ac/jpn/index.php?mjwrt/mjwrt2019)

# Report on CS/CQ Joint Session at 2019 IEICE General Conference – BI-5 Applications of Communication Technologies in Various Areas –

Kenko Ota<sup>1</sup>, Kenji Kanai<sup>2</sup>, Takanori Hayashi<sup>3</sup>, Hideyuki Shimonishi<sup>4</sup>,  
Jun Okamoto<sup>5</sup>, Daisuke Ikegami<sup>5</sup>, Chikara Sasaki<sup>6</sup>, Yoshiaki Nishikawa<sup>4</sup>,  
Ryo Yamamoto<sup>7</sup>, Hidenori Nakazato<sup>2</sup>, Jun Terada<sup>5</sup>,  
Masamitsu Fujiwara<sup>5</sup>, Kazutaka Hara<sup>5</sup> and Kentaro Toyoda<sup>8</sup>  
<sup>1</sup>Nippon Inst. of Tech., <sup>2</sup>Waseda Univ., <sup>3</sup>Hiroshima Inst. of Tech., <sup>4</sup>NEC,  
<sup>5</sup>NTT, <sup>6</sup>KDDI, <sup>7</sup>The Univ. of Electro-Comm., <sup>8</sup>Keio Univ.



## 1. Introduction

Technical committees on Communication Systems (CS) and Communication Quality (CQ) held a joint session which was named as applications of communication technologies in various areas at 2019 IEICE General Conference. Figure 1 shows a picture of joint session. The abstract of this session is shown as follows: Communication technology is originally a technology created for communication between people, but its surplus capabilities are not limited to communication between people but are applied in various areas. In this joint session, we will explore a wide range of application examples of communication technology and the possibilities including the purpose of use other than communication. In this report, we introduce the abstracts of 6 invited talks.

## 2. Abstracts of 6 Invited Talks

The abstracts of 6 invited speakers in this joint session are shown as follows.

### “Batteryless Wearable System ~Wireless Transceivers embedded in Diapers and False Eyelashes~” [1]

Frist talk is done by Prof. Takakuni Doseki from Ritsumeikan University, and he gives a talk about ultralow-power wireless sensors and batteryless wearable system to monitor daily people’s life semi-permanently. In this talk, he introduces several “unique” prototype wearable sensors and systems by using personal belongings such as “diapers” and “false eyelashes”. By using diapers, he developed a wireless urine leakage detection sensor that enables to generate power from user’s urine. In case of false eyelashes, he embedded an energy harvesting device to the false eyelashes and invented shining false eyelashes to enhance fashionability. His research activities are quite unique and interesting, and his energetic attitude against research activity provides good influence on the audiences.



Fig. 1 Picture of Joint Session.

### “Short-Range Communications Using Electric and Magnetic Fields” [2]

Second talk is provided by Prof. Ai-ichiro Sasaki from Kindai University, and he gives a talk about short range communications using electric and magnetic fields. This work is a joint research with NTT. He lectures the basic concept of near electromagnetic field and introduces intra-body communication as an application of near electromagnetic field. Current short-range communications (or near field communication (NFC)) is achieved by using IC cards such as FeliCa and Suica in Japan. In contrast, he seeks to achieve short-range communications by not using any IC cards (or other devices) but only using human bodies. In the near future, thanks to this technology, we will be able to exchange information by just touching with our hands. He emphasizes that the technology of near electromagnetic still has many challenging issues, and this research field is quite attractive.

### “Brain-inspired information processing in an impulse-based wireless sensor network” [3]

Third talk is presented by Prof. Naoki Wakamiya from Osaka University, and he gives a talk about brain-inspired information processing to achieve ultralow-power, low-cost, and high-fault tolerance impulse-based wireless sensor network. In his proposal, he assumes the wireless sensor network as a spiking

neural network and applies human-brain's information processing mechanism to the spiking neural network. In other words, he models and designs the human-brain's information processing mechanism over wireless sensor network. His approach can extract (or process) information without topology control and routing control of wireless sensor network, but only with simple signal processing and broadcast transmission. His research is based on bioinformatics (similar to the final speaker) and he continuously seeks to apply biomechanism to information communication technology.

#### **“Monitoring Techniques with Radio Waves” [4]**

Fourth talk is given by Prof. Tomoaki Otsuki from Keio University. He introduces monitoring technology using radio waves as a technology to realize monitoring at home while protecting privacy. The monitoring technology using radio waves is called radio wave sensor, and wireless tomography, array sensor, MIMO sensor and Doppler sensor are introduced as specific examples. Wireless tomography identifies the presence and location of people in an area based on the RSS attenuation of each radio link. The array sensor detects and identifies human actions and states based on the eigenvectors and eigenvalue statistics configuring the signal subspace. MIMO sensor is a sensor that detects changes in propagation due to human presence and behavior based on changes in the propagation channel. The Doppler sensor emits radio waves, and detects the speed and movement of people and objects by comparing the frequency of the reflected radio waves with the frequency of the emitted radio waves. In addition to behavior, the Doppler sensor can detect minute biological signals such as heartbeat, breathing, and blinking in a non-contact manner.

#### **“Basic verification on detection of bolt disengagement of bridge installation equipment using optical cable for communication” [5]**

Fifth talk is provided by Ms. Chihiro Saito from NTT. She introduces a technology that uses communication technology to confirm loosening of bolts in pipeline equipment attached to bridges. The proposed method focuses on the fact that the natural frequency of the pipe changes when the bolt is loosened, and measures the vibration characteristics of the pipe using an optical cable for communication laid in the pipe as a sensor. She has created a device simulating a bridge installation facility, and verified whether changes in vibration characteristics of pipes due to loose bolts could be detected. An interferometric method is used for optical sensing. Natural frequency analysis by FFT is applied to the vibration data obtained by sensing. As a result, the natural frequency increased as the torque value increased, and the possibility of detecting bolt looseness or detachment was demonstrated by interferometric sensing with an optical cable.

#### **“Proposal of communication method learned from frog chorus” [6]**

Final talk is done by Prof. Ikkyu Aihara from University of Tsukuba, and this research is collaborated with Osaka University. Research on biomimetics that develops new materials and technologies based on the structure and behavior of living organisms is actively underway. He introduces the research that proposed the communication method on the wireless sensor network based on the frog's choral law. The Japanese tree frog males shift the timing of croaking of each other on the short-time scale, and form a choral state on the long-time scale. He reproduced this property qualitatively using a hybrid dynamic model that switches between croaking and resting states according to internal degrees of freedom (energy and fatigue) and interaction. Next, the effectiveness of operating this frog chorus model as an autonomous decentralized communication system on a wireless sensor network was verified by numerical simulation.

#### **3. Conclusion**

We held a joint session at 2019 IEICE General Conference. The applicability of communication technology to various fields was shown. There were 47 participants. It was a meaningful session with many people participating.

#### **4. Acknowledgements**

We would like to give thanks to 6 invited speakers due to their great contributions to this joint session.

#### **5. References**

- [1] Takakuni Doseki, “Batteryless Wearable System ~Wireless Transceivers embedded in Diapers and False Eyelashes~,” IEICE General Conference, BI-5-1, March 2019.
- [2] Ai-ichiro Sasaki and Morimura Hiroki, “Short-Range Communications Using Electric and Magnetic Fields,” IEICE General Conference, BI-5-2, March 2019.
- [3] Naoki Wakamiya, “Brain-inspired information processing in an impulse-based wireless sensor network,” IEICE General Conference, BI-5-3, March 2019.
- [4] Tomoaki Otsuki, “Monitoring Techniques with Radio Waves,” IEICE General Conference, BI-5-4, March 2019.
- [5] Chihiro Saito, Yuta Ikeguchi, Daisuke Iida, Yoshifumi Wakisaka and Masafumi Nakagawa, “Basic verification on detection of bolt disengagement of bridge installation equipment using optical cable for communication,” IEICE General Conference, BI-5-5, March 2019.
- [6] Ikkyu Aihara, Daichi Kominami, Yushi Hosokawa and Masayuki Murata, “Proposal of communication method learned from frog chorus,” IEICE General Conference, BI-5-6, March 2019.



# Report on Japan-China Workshop on the Next Generation Mobile Communication Technology and Application 2019

Toshihiko Nishimura<sup>†</sup>, Satoshi Suyama<sup>✳</sup>  
<sup>†</sup>Hokkaido University, <sup>✳</sup>NTT DOCOMO, INC.



## 1. Introduction

Japan-China Workshop on the Next Generation Mobile Communication Technology and Application 2019 (JC-WS 2019) was organized in conjunction with FuTURE MOBILE COMMUNICATION FORUM, Japan-China ICT Technology Forum, and YRP R&D Promotion Committee, and was held in Harbin, China, on August 10<sup>th</sup>-11<sup>th</sup>, 2019. JC-WS 2019 is technically cosponsored by IEICE Communication Society. The workshop focused on the latest 5G system trials and evaluation results in Japan and China and radio access technologies for beyond 5G and future mobile communication systems.

## 2. Workshop Program

Technical presentations of the workshop were held on August 10<sup>th</sup>-11<sup>th</sup> for two days. There were 17 presentations including keynote presentations. The first keynote presentation in the morning session was provided by Prof. Jiao Bingli, Peking University. His keynote presentation was titled “Exceeding the Channel Limit of BPSK Input with Theoretical Calculation and Practical coding Scheme”. The second keynote presentation was given by Prof. ADACHI Fumiuyuki, Tohoku University (Fig. 1). His keynote titled “Spectrum efficiency and scalability-enhanced distributed MIMO”. In addition to the keynote presentations, Special Session “R&D Activities for 5G and Beyond in Japan” was organized by Technical Committee on Radio Communication Systems (RCS) of IEICE.

## 3. Special Session of Technical Committee on RCS

The workshop consists of a special session in

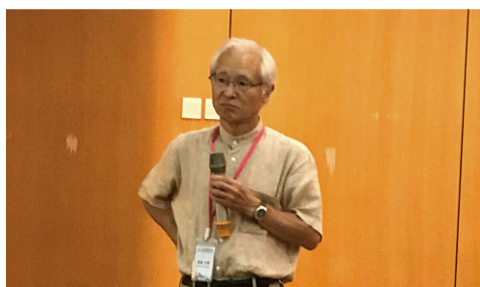

Fig. 1 Keynote presentation by Prof. Adachi.

addition to regular technical presentations; R&D Activities for 5G and Beyond in Japan. There were about 30 participants and intensive discussions were held. Four speakers of IEICE RCS’s Special Session are from NTT DOCOMO, INC., NEC Corporation, and NICT, Japan (Fig. 2). The topics include the follows;

- R&D Activities and Field Trials toward 5G Actualization in Japan
- Low SHF Band C-RAN Massive MIMO System for 5G
- Research and Development on Coordinated Management and Flexible Spectrum Utilization toward 5G Era
- 5G R&D Activities of Millimeter-Wave Base Station Cooperation Technologies for High Mobility Transportation

## Acknowledgements

We would like to give thanks to speakers, participants, and staffs of JC-WS 2019 (Fig.3).



Fig. 2 Special session speakers.



Fig. 3 Group photo.

## Nice Teamwork Lead to the Success in International Geoscience and Remote Sensing Symposium (IGARSS) 2019 Yokohama

Akira Hirose

Dept. of Electrical Eng. & Inform. Sys., The University of Tokyo



The 39<sup>th</sup> IEEE International Geoscience and Remote Sensing Symposium (IGARSS 2019), held from July 28<sup>th</sup> to August 2<sup>nd</sup>, 2019, at PACIFICO Yokohama, Japan, gathered over 2,500 participants from 56 countries and areas successfully. We organized 1,061 oral presentations as well as 1,551 posters with SPRINT (Short Presentation of Interactive Content) highlight presentations in total.

We had four plenary presentations. Dr. Hiroshi Yamakawa, the President of JAXA (Japan Aerospace Exploration Agency), presented the space activities in Japan. Ms. Sandra Cauffman, the acting director of NASA (National Aeronautics and Space Administration) Earth Science Division, explained the recent earth science activities of NASA. Prof. Gilberto Câmara, the Secretariat Director of GEO (Group on Earth Observations), discussed the future way of the remote sensing. Dr. Franz Ming-Chih Cheng, the Director of International Affairs Office, National Applied Research Laboratories, Sentinel Asia, introduced the international collaboration in Asian countries.

One of the most remarkable events was the Opening Ceremony held in a solemn but warmest atmosphere by being graced with the presence of Their Majesties the Emperor and Empress as shown in Fig. 1. The address of His Majesty the Emperor included “To develop effective measures for the preservation of the global environment, it is indispensable for us to have detailed and accurate data and their analyses. I am confident that the main subjects of this symposium, namely, remote sensing technology to observe the surface and the inside of the earth from space as well as the big-data analysis and processing technology will be highly effective measures for that purpose.” The participants renewed their commitment to the research in the geoscience and remote sensing area.

We held many social events (Figs. 2-11). The local organizing committee (LOC) had the fortune to hear favorable words from many participants concerning the venue and the operation such as “very convenient,” “well organized” and “most enjoyable.” As the General Chair, I found that such positive evaluation is attributed to the good LOC teamwork. Another key point is that the goal to provide “best experience for all the participants,” which IEEE Geoscience and Remote Sensing Society (GRSS) President Paolo Gamba and I confirmed at the

GRSS administrative committee meetings, was sufficiently shared by all the LOC members.

Other reports are found in IEEE Geoscience and Remote Sensing Magazine [1, 2] and sponsors’ reports.

The LOC is grateful for the strong support of IEICE Communications Society as a technical co-sponsor.



Fig. 1 Opening Ceremony with the attendance of Their Majesties the Emperor and Empress.



Fig. 2 “Earth Observation Using Remote Sensing: Investigation from Space” for elementary school & junior high school students using NASA Hyperwall held with the support of Culture and Tourism Bureau, City of Yokohama.





Fig. 3 Four days' GRSS Summer School held in the preceding week including lectures, hands-on training and a technical excursion to visit JAXA in Tsukuba.



Fig. 6 "Miura-ori" program at a glance for eco-friendly conference operation.



Fig. 4 The Izakaya (Japan-style pub) walking tour "Noge Night" to enjoy local Japanese foods supported by PACIFICO Yokohama and Yokohama City.

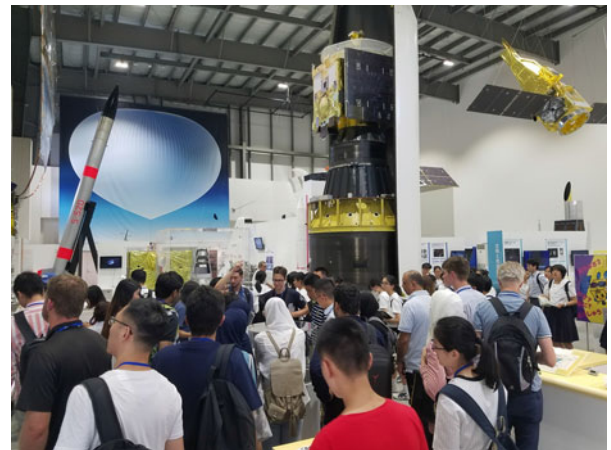

Fig. 7 Technical tour visiting ISAS/JAXA in Sagami-hara to learn the cutting-edge space technology.



Fig. 5 "IGARSS World Cup 2019" held at Higashi-Totsuka Football Park where 30 players showed exciting fair play.



Fig. 8 "Connection to IGARSS 2020" in Closing Ceremony with 20,000 fireworks on the last evening.





Fig. 9 Post Conference Tour visiting Arahama Elementary School, Sendai, with a banner on the back: “Thank you, Arahama Elementary School” on the school building preserved as an earthquake relic in a tsunami-affected area.



Fig. 10 SNS page attracting people timely and widely.



Fig. 11 A part of the LOC members on the first day of the Conference gathering to check the final logistics.

## References

- [1] Alberto Moreira, et al., “IGARSS in Yokohama, Japan: Impressions from the First Days,” IEEE Geoscience and Remote Sensing Magazine, 7, 3 (2019) 8-19.
- [2] Akira Hirose, et al., “IGARSS 2019 in Yokohama, Japan: Events and New Trials,” IEEE Geoscience and Remote Sensing Magazine, to appear

# Report on EMC Sapporo & APEMC 2019

Yoshiki Kayano, Yuichi Hayashi  
Public Relations Working Group of Organizing Committee  
of EMC Sapporo & APEMC 2019



## 1. Introduction

2019 Joint International Symposium on Electromagnetic Compatibility and Asia-Pacific International Symposium on Electromagnetic Compatibility, Sapporo (EMC Sapporo & APEMC 2019) [1] was held at “Sapporo Convention Center”, Sapporo, Hokkaido, from June 3<sup>rd</sup> to 7<sup>th</sup>, 2019. EMC Sapporo & APEMC 2019 is the 8<sup>th</sup> “International Symposium on Electromagnetic Compatibility” organized by IEICE Technical Committee on Electromagnetic Compatibility (EMCJ), sponsored by IEICE Communications Society (CS) and the first joint symposium under technical co-sponsorship by Asia-Pacific EMC (APEMC). The Symposium was technically co-sponsored by the IEEE Electromagnetic Compatibility Society (EMC-S), the Technical Committee on EMC of the Institute of Electrical Engineers of Japan (IEEJ) and ISC of Asia-Pacific EMC Symposium (APEMC)

It was also technically cooperated by national and international organizations related to academic and standardization activities on electromagnetic compatibility.

This EMC Symposium series has a long history and it has been held every 5 years. The first of its series was held in Tokyo in 1984, which was the first IEEE EMC Symposium held outside USA sharing sponsorship with IECE. Ever since the second in 1989, this symposium series has been sponsored by IEICE.

## 2. Organization

The Organizing Committee (OC) of EMC Sapporo & APEMC 2019 was formed under IEICE-CS, with the chairperson Prof. Hideaki Sone (Tohoku Univ.) The OC consists of General affairs sub-committee, Registration sub-committee, and Executive Committee.

## 3. Conference Statistics

Totally 432 persons, including 13 invited attendees and 93 students, from 26 countries attended the Symposium. Attendees consisted of 209 persons from Japan and 223 persons from foreign countries. Total of 271 papers were presented. Technical program of EMC Sapporo & APEMC 2019 consists of regular sessions, organized sessions, workshops, and tutorial sessions. Table 1 shows the list of attending countries. We note that approximately 1/2 of attendees were from foreign countries.

Table 1 List of attending countries

Country/Region	Attendees
Australia	4
Austria	1
Belgium	1
Brazil	2
China	60
Croatia	3
Finland	3
France	8
Germany	14
Hong Kong	3
India	3
Italy	4
Japan	209
Malaysia	2
Netherlands	5
Pakistan	0
Philippines	1
Republic of Korea	40
Republic of Moldova	1
Singapore	6
Spain	2
Sweden	1
Switzerland	2
Taiwan	37
USA	20
<b>Total</b>	<b>432</b>

#### 4. Conference Schedule

The Symposium was held during June 3<sup>rd</sup> to 7<sup>th</sup> (5 days). In the evening on June 3<sup>rd</sup>, Welcome Party was held at Reception Venue. Participants gathered and enjoyed their food, drink, and talk with their friends and colleagues. In the morning on June 4<sup>th</sup>, Plenary Session was programed. On June 5<sup>th</sup>, Banquet and Award Ceremony were held at Sapporo Park Hotel from 19:00 to 21:00. In addition, public seminar on “IoT, Electromagnetic Wave and EMC” was conducted as an outreach activity of EMC Sapporo and APEMC 2019.

#### 5. Technical Program

The proceedings of EMC Sapporo & APEMC 2019 include 268 original papers in total in 24 regular sessions and 23 organized sessions. These papers and additional 26 presentations for workshops and tutorial sessions were presented in four parallel sessions.

For regular sessions, 224 papers were submitted from 27 countries, and 180 papers were accepted. For the organized sessions, 93 original papers were accepted.

Full length papers, except for organized sessions and papers which were accepted but not presented at the symposium, will be included in the “IEICE Proceedings Archives”, and the “IEEE Xplore”, based on the agreement between IEICE and IEEE.

The specific topics in EMC Sapporo & APEMC 2019 are “Biological Effect and Safety” (17 % of regular sessions and organized sessions papers) and “PCB and Device Level EMC” (9.3 %), though “EMI/EMC Measurement Technology” (9.3 %) has been the largest portion of the topics. In particular, “Threat of Security Degradation Due to EM Leakage and Low-Power IEMI and Its Countermeasures” has become a focus of research. “EMC in Automotive” is another important topic with increase of papers.

#### 6. Plenary Session and Keynote Session

The Keynote Session was chaired by Prof. Hideaki Sone, Tohoku Univ. and Prof. Osami Wada, Kyoto University. In the Keynote Session, following two talks were given. The title of the 1st talk was “Human Exposure Standards - Role of Computational Dosimetry” by Prof. Akimasa Hirata, Nagoya Institute of Technology, Japan (Fig. 1). The title of the 2nd talk was “Electromagnetic Safety in Wireless Power Transfer Technology” by Prof. Seungyoung Ahn, Korea Advanced Institute of Science and Technology (KAIST), Korea (Fig. 2).

#### 7. Awards

Awardees were selected by Technical Program Committee as follows.

##### ● Risaburo Sato Award

“A Novel Estimation Technique Using K-Order Models to Evaluate the Maximum Electric Field of

Multiple-Antenna Transmitters”, Dinh Thanh Le, Kun Li, Soichi Watanabe and Teruo Onishi (Fig. 3)

##### ● Excellent Paper Award

“Further Effects of Test Voltages, Relative Humidity and Temperature on Air Discharge Currents from Electrostatic Discharge Generator”, Takeshi Ishida and Osamu Fujiwara

“Introduction of the Amplitude Probability Distribution (APD) Measurement in CISPR 32”, Toshio Chiyojima

“Setting Reference Level in Human Safety Guidelines via Cortical Nerve Activation Intercomparison at IF”, Jose Gomez-Tames, Essam Rashed, Akimasa Hirata, Thomas Tarnaud, Emmeric Tanghe, Tom Van de Steene, Luc Martens and Wout Joseph

“Frequency-Domain Characterization and Modelling of a Multi-Layer Ceramic Capacitor for RF Applications”, Hrvoje Stimac, Raul Blečić, Renaud Gillon and Adrijan Baric

##### ● IEEE EMC Society Japan Joint/Sendai Chapters Student Award

“Miniaturized Quarter-Wavelength Resonator for Common-Mode Filter Based on Pattern Ground Structure”, Hsu-Wei Liu, Chi-Hsuan Cheng and Tzong-Lin Wu

“Circuit Design for Common-Mode Noise Rejection in Biosignal Acquisition Based on Imbalance Cancellation of Electrode Contact Resistance”, Minghui Chen, Daisuke Anzai, Jianqing Wang and Georg Fischer

“Modeling and Analysis of Multiple Coupled Through-Silicon Vias (TSVs) for 2.5-D/3-D ICs”, Kyungjun Cho, Youngwoo Kim, Junyong Park, Hyesoo Kim, Seongguk Kim, Subin Kim, Gapyeol Park, Kyungjune Son and Joungho Kim

#### 8. Banquet & Award Ceremony

The social highlight of EMC Sapporo & APEMC 2019 was the Banquet & the Award Ceremony which was held on Wednesday evening at Sapporo Park Hotel (Fig. 4). The banquet began with Kagami-Biraki, which is Japanese traditional ceremony in which the lid of a sake barrel is broken open by mallets. We also experienced an exciting and fantastic “Yosakoi Soran” (Japanese dance) entertainment. At the Award Ceremony, which was held in the banquet, the winners were commended for their outstanding achievements.

#### 9. Technical Exhibition

A technical exhibition was performed at the symposium venue from June 3<sup>rd</sup> to 7<sup>th</sup>, 2019, by EMC



related companies and organizations. The number of exhibitors was 32 including companies, supercomputer-related public organizations and public research organizations.

## 10. Public Seminar

A seminar for general public on “IoT, Electromagnetic Wave and EMC” [2] was held on the June 8<sup>th</sup>, 2019. Three lectures relating to EMC matters in plain words were given by Dr. Kaoru Gotoh (NICT), Prof. Yoshitaka Toyota (Okayama Univ.) and Prof. Yuichi Hayashi (NAIST) (Fig. 5). A lively discussion was conducted among lecturers and attending people.

## 11. Conclusion

We believe EMC Sapporo & APEMC 2019 was a successful event. We owe very much for this success to all those involved in the Symposium. We would like to thank for the contributions to the Symposium of all participants, all committee members, and staffs for their hard work, and of all the technical and financial sponsors.

## 12. References

- [1] <https://www.ieice.org/~emc2019/index.html>
- [2] [https://www.ieice.org/~emc2019/seminar\\_in\\_JP.html](https://www.ieice.org/~emc2019/seminar_in_JP.html) (in Japanese)



Fig. 1 Plenary talk by Prof. Akimasa Hirata.



Fig. 2 Plenary talk by Prof. Seungyoung Ahn.



Fig. 3 Winners of Risaburo Sato Award and Chairs.



Fig. 4 Banquet and Award Ceremony.



Dr. Kaoru Gotoh



Prof. Yoshitaka Toyota



Prof. Yuichi Hayashi  
Fig. 5 Public Seminar.

# Report on OECC/PSC 2019

Kimio Oguchi<sup>†</sup> and Akihiro Maruta<sup>‡</sup>

<sup>†</sup>National Taiwan University of Science and Technology

<sup>‡</sup>Osaka University



## 1. Introduction

OECC/PSC 2019 conference was held from 7<sup>th</sup> through 11<sup>th</sup> in July, 2019 at Fukuoka International Congress Center, Fukuoka, Japan (Fig. 1). The conference brought together international leading researchers, scientists and engineers who have been actively working in optical devices and modules, optical transmission and optical networking, optical fibers, optical switching and computing systems, and related technologies. The conference combined the following two major international conferences, which widely covered in the field of “optics (photonics)” from devices and modules to systems and networks.

- The 24<sup>th</sup> OptoElectronics and Communications Conference (OECC 2019)
- International Conference on Photonics in Switching and Computing 2019 (PSC 2019)



Fig. 1 Entrance signage at Fukuoka international congress center.

The combination of these conferences made this the most significant and valuable conference for participants from all over the world, and also provided forums for the discussion of significant progress of research and development of appropriate technologies.

The conference was cosponsored by IEICE Communications Society and IEICE Electronics Society, and technically cosponsored by IEEE Photonics Society, IEEE Communications Society, and The Optical Society.

## 2. Outline and Results of the Conference

Statistics of the conference is summarized in Table 1.

Table 1 Statistics of OECC/PSC2019

Submitted contributed papers	453 (23 countries)
Accepted contributed papers	341 (75.3%)
Oral presentation papers	203 (44.8%)
Poster presentation papers	138 (30.5%)



Fig. 2 Plenary session.

As shown in this table, 453 papers were submitted to the conference from all over the world (23 countries), and each paper was reviewed by each category expert researchers. After the review, total 341 papers were accepted for the oral (203) and poster presentation (138), hence the total acceptance ratio of the conference was 75.3%. The accepted 203 oral papers were categorized into 7 technical scopes. The technical scopes were:

- O1. Core/Access/Data Center Networks and Subsystems
- O2. Transmission Systems and Subsystems
- O3. Optical Fibers, Cables and Fiber Devices
- O4. Optical Active Devices and Modules
- O5. Optical Passive Devices and Modules
- P1. Photonics in Switching Technologies, Systems, and Architectures for Communications and Networking
- P2. Photonics in Switching Technologies, Systems, and Architectures for Computing and Big Data

The conference was started with 4 workshops in the afternoon of July 7<sup>th</sup>: WS1. Machine learning for optical network and transmission –Why and where? –, WS2. Recent efforts and progress towards deployment and standardization of SDM technology (Part I: Overview of SDM research initiatives / Part II: Efforts towards realization, applications and standardization of SDM technologies), WS3. How to establish a sustainable ecosystem for photonic integrated circuits? What are major hurdles to overcome?, WS4. Wired and wireless network convergence in 5G/IoT era.

The plenary session was organized on July 8<sup>th</sup> (Fig. 2). In the first, Dr. Yasuyuki Nakajima, KDDI research Inc., Japan, addressed digital transformation and its impact in 5G/post 5G era. The second by Dr. Alexei Pilipetskii, SubCom, USA, presented submarine communications-connecting the world. The third by





Fig. 3 Oral session.

Prof. Meint K. Smit, Eindhoven University of Technology, The Netherlands, addressed progress in InP-based photonic integration. The fourth by Prof. Keren Bergman, Columbia University, USA, introduced flexibly scalable high performance architectures with embedded photonics.

In the technical sessions, there were 434 presentations (Fig. 3) in 73 technical sessions (4 days 7 parallel tracks) with including 2 poster sessions (Fig. 4), 7 tutorial talks (Optically-interconnected data center architectures, systems, and enabling technologies by Prof. S. J. Ben Yoo, University of California, Davis, USA, Scaling optical networks through SDM technologies, by Dr. Peter J. Winzer, Nokia Bell Labs, USA, Design and manufacturing of ultra-low loss optical fibers by Dr. Yoshinori Yamamoto, Sumitomo Electric Industries, Ltd., Japan, Photonic crystal technology for Datacom and LiDER applications by Prof. Toshihiko Baba, Yokohama National University, Japan, Plasmonics for communications by Prof. Juerg Leuthold, ETH Zurich, Switzerland, Optical networks in data centers by Prof. Jiajia Chen, Chalmers University of Technology, Sweden, Machine learning applications in optical networks by Prof. Massimo Tornatore, Politecnico di Milano, Italy & University of California, Davis, USA) and 3 special symposia (S1. Future technologies for optical transport network support of post 5G mobile services, S2. Photonics technologies in automotive application –from networks to devices–, S3. Advanced optical technologies for Bigdata / IoT service).

On July 10<sup>th</sup>, we enjoyed the banquet (Fig. 5) where the Hotel Okura was offered and Japanese traditional music and dance were performed by Kashiigu Gagaku group and Geigi ladies, respectively. And, the best



Fig. 4 Poster session.

paper awards (7, one paper in each sub-committee) and the best student paper awards (7, one paper in each sub-committee) of OECC/PSC 2019 were introduced in the banquet (Fig. 6).

The post deadline papers of 13 were submitted to the conference from all over the world and each paper was reviewed by the technical committee members. After the review, total 5 papers were accepted. The post deadline paper presentations were performed with a single session on July 10<sup>th</sup>.

### 3. Conclusion

OECC/PSC 2019 was closed with great success. Finally 634 participants (registrations) with including 291 international participants (about 46%) and 173 students (about 27%) have enjoyed discussion in this conference.

OECC 2020 is announced to be held at Taipei, Taiwan, and PSC 2020 at Montreal, Canada.



Fig. 5 Group Photo at Banquet.



Fig. 6 Awarding Ceremony in Banquet.



Fig. 7 Coffee break in Exhibition area.



# Report on the 18<sup>th</sup> International Workshop on Assurance in Distributed Systems and Networks (ADSN2019)

Junichi Funasaka  
Hiroshima City University



## 1. Introduction

The International Workshop on Assurance in Distributed Systems and Networks (ADSN) was initiated in Vienna, Austria in 2002, and after the great success of 17 continent events, the 18<sup>th</sup> workshop was held in Fukuoka, Japan on August 7, 2019 in conjunction with the 17<sup>th</sup> IEEE International Conference on Dependable, Autonomic and Secure Computing (DASC 2019). The details of the workshop can be found on [1].

## 2. Objective and Definition of ADSN

The objective of the workshop is to provide an effective forum for original scientific and engineering advances in Assurance in Distributed Systems and Networks. Along with recent rapid growth of the Internet and ubiquitous networks, applications for autonomous decentralized systems are emerging in many important areas like transportation, automotive systems, smart energy grids and the Internet of Things (IoT) to name a few. In these distributed systems and networks, heterogeneous requirements are independently generated and the requirements themselves are frequently changing. Assurance in these distributed systems and networks is defined as capability of guaranteeing functional and non-functional system properties such as dependability, security, timeliness and adaptability in heterogeneous and changing environments.

## 3. ADSN 2019 Organization

ADSN 2019 organizers are as follows.

- General Co-Chairs: Tomohiro Ohtani, KDDI Research, Inc., Yoshiaki Kakuda, Hiroshima City University
- Program Chair: Junichi Funasaka, Hiroshima City University
- Vice Program Chairs: Guojun Wang, Guangzhou University, Elisa Bertino, Purdue University, Felicita Di Giandomenico, ISTI-CNR

The Program Committee consists of 19 members from Asia, Europe and Americas, including Program Chair and three Vice Program Chairs.

## 4. ADSN 2019 Program

Eight papers have been submitted to the workshop. As a result of comprehensive reviews by the Program



Fig. 1 Keynote Speech.

Committee, seven high quality papers were selected to be included in the program of ADSN 2019.

The half-day program consists of the following four sessions.

**Session 1:** Keynote Speech (Chair: Tomohiro Ohtani), Prof. Yukikazu Nakamoto, “Some Technology Issues in a Connected World”

**Session 2:** Assurance technologies for dynamically changing networks (Chair: Tomoyuki Ohta), 3 papers.

**Session 3:** Invited Speech (Chair: Junichi Funasaka), Mr. Eiji Utsunomiya, “Information Propagation that Induces Evacuation Behavior at the Time of Disaster”

**Session 4:** Assurance technologies for disaster evacuation (Chair: Tatsuhiro Tsuchiya), 2 papers.

About twenty participants joined the workshop and enjoyed paper presentations and discussions. Various approaches, such as graph theories and practical observatory systems for detecting disasters, have stimulated active and fruitful discussions. We think that the assurance technologies to realize dependability, security, timeliness, and adaptability should be more important in IoT environments or connected worlds with heterogeneous and changing demands from now on.

## 5. Summary

This report has concisely explained ADSN 2019, which is the longest workshop in CyberSciTech Congress 2019, consisting of DASC 2019 and other co-located conferences.

## 6. Reference

- [1] <http://adsn.net.info.hiroshima-cu.ac.jp/>

# Report on 20<sup>th</sup> Asia-Pacific Network Operations and Management Symposium (APNOMS 2019)

Hironori Kurokawa\* and Kiyohito Yoshihara\*\*

\* Secretary of APNOMS 2019 and NTT East

\*\* General Chair of APNOMS 2019 and KDDI Research

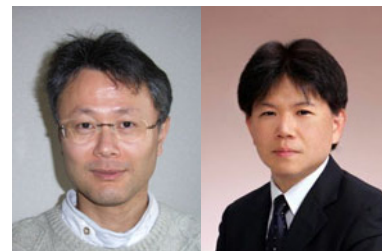

## 1. Overview

The 20<sup>th</sup> Asia-Pacific Network Operations and Management Symposium (APNOMS 2019) was held from September 18<sup>th</sup> to 20<sup>th</sup> in Matsue, Japan. It is organized by Technical Committee on Information and Communication Management, the Institute of Electronics, Information and Communication Engineers (IEICE ICM) and the committee on Korean Network Operations and Management, the Korean Information and Communications Society (KICS KNOM), and is technically co-sponsored by IEEE Communications Society.

APNOMS 2019, with its theme being “Management in a Cyber-Physical World,” consists of 5 keynote speeches, a distinguished expert panel, 1 special session, 4 tutorial sessions, 9 technical sessions, 3 poster sessions, 1 innovation session, 1 demo session, a new session from this year and 6 exhibition booths. About 200 people from 11 countries participated in the conference.

## 2. Highlights

Five executives delivered keynote speeches from each perspective. Dr. Tohru Asami from Advanced Telecommunications Research Institute International gave a speech on “Challenges of Network as a Foundation for Diverse Businesses,” Prof. Nen-Fu (Fred) Huang from National Tsing Hua University introduced “A IoT based Smart Agriculture Blockchain Service,” Prof. Choong Seon Hong from Kyung Hee University gave a speech on “Edge Computing for 5G Networks and Beyond,” Mr. Ray Budavari from VMware, Inc introduced “Solving key challenges in data center networking and security with distributed analytics” and Prof. Kotaro Kataoka from Indian Institute of Technology Hyderabad gave a speech on “Interplay between Internet and Blockchain.”

In the distinguished expert panel session, Prof. Mianxiong Dong from Muroran Institute of Technology, Dr. Yongseok Park from Samsung Electronics, Dr. Yuh-Jiuh Cheng from Chunghwa Telecom Co., Ltd and Dr. Richard T.B. Ma from National University of Singapore discussed various emerging topics about network operations and management with chair and audiences.

The special session covered the topics of “AI Solutions for Challenging Network Management



Fig. 1 Welcome address by General Chair, Dr. Kiyohito Yoshihara.



Fig. 2 Announcement of the next APNOMS by Vice Co-Chair, Prof. Hongtaek Ju.

Situations” and “API for Trouble/Maintenance Notification toward Automatic Operation.”

In the demo session, there were 2 demonstrations. One of them was demonstrated with some devices that helped audiences to understand their conception.

A total of 127 papers, including 31 papers from Japan, were submitted to APNOMS 2019, among which 35 papers (9 from Japan) were accepted to be presented in the technical sessions. Besides, 78 papers (19 from Japan) were accepted to be presented in poster style in poster sessions. These papers are to be included in IEICE Publications Search System and IEEE Xplore.

The technical program committee and organizing committee selected the top 4 papers and the top 4 students with the highest overall scores from technical sessions as “Best Paper Award” and “Best Student Paper Awards”, respectively. One of the awardees of “Best Paper Award” is “Detecting Wireless LAN Bottlenecks Using TCP Connection Measurement at Traffic Aggregation Point” presented by Dr. Sumiyo Okada from Fujitsu Laboratories Ltd. And one of the awardees of “Best Student Paper Award” is “Cache-Decision Policy Using User Tastes” presented by Mr. Tsukasa Kitamura from Kansai University.

### **3. Summary**

APNOMS 2019 was closed with great success. On behalf of all organizing committee members, we would like to express our appreciation to all parties involved in this conference.

The next APNOMS will be held in Daegu, Korea in 2020.



# Report on International Workshop on Technology Trials and Proof-of-Concept Activities for 5G Evolution & Beyond 5G 2019 (TPoC5GE 2019)

Yukitoshi Sanada  
Keio University



## 1. Introduction

International Workshop on Technology Trials and Proof-of-Concept Activities for 5G Evolution & Beyond 5G 2019 (TPoC5GE 2019) was organized in conjunction with IEEE Vehicular Technology Conference (VTC) 2019 Fall, which was held in Honolulu, Hawaii, on Sept. 22<sup>nd</sup> - Sept. 25<sup>th</sup>, 2019. TPoC5GE 2019 is technically cosponsored by IEEE VTS Tokyo Chapter and IEICE Communication Society. It is also supported by the Technical Committee on Radio Communication Systems (RCS), IEICE. TPoC5GE workshops were held at IEEE VTC 2017 Spring, 2018 Spring, and 2019 Spring. Thus, it was the fourth time to be held. The workshop focused on the latest trials and evaluation results for 5G and the proof-of-concept activities for beyond 5G.

## 2. Conference Program

The workshop was held in the afternoon on Sep. 22<sup>nd</sup> for a half day. There were 10 presentations including two keynote presentations. The first keynote presentation was provided jointly by Prof. Lee from Dankook University and Dr. Okumura from NTT DOCOMO. Their keynote presentation was titled “Outcomes of Korea - Japan Joint 5G Collaboration”. Their talk was about the results of joint research between 5G Forum in Korea and 5GMF in Japan. It was about the measurement campaigns for high speed train applications.

The second keynote presentation was provided by Prof. Sampei from Osaka Univ. His keynote presentation was titled “5G, current and future?”. His talk was about the new features of beyond 5G including the IoT applications, local 5G, and so on.

## 3. Technical Sessions

The workshop consists of two technical sessions. There were about 35 participants and intensive discussions were held. The topics of the presentations include the topics such as edge content delivery, truck platooning, massive MIMO technology, distributed antenna systems, and channel extrapolation for FDD massive MIMO.

## 4. Acknowledgements

The TPoC5GE 2019 committee members would like to give thanks to authors, speakers, participants, and staffs.



Fig. 1 Keynote presentation by Prof. Lee.



Fig. 2 Keynote presentation by Dr. Okumura.



Fig. 3 Keynote presentation by Prof. Sampei.

# Report on the 11<sup>th</sup> International Conference on Ubiquitous and Future Networks (ICUFN) 2019

Seong-Ho Jeong\*, Takeo Fujii\*, Dongkyun Kim\*\*, Insoo Sohn\*\*  
\*Organizing Chairs of ICUFN 2019, \*\* TPC Chairs of ICUFN 2019



## 1. Introduction

The 11<sup>th</sup> International Conference on Ubiquitous and Future Networks (ICUFN) 2019 was held in Zagreb, Croatia from July 2 to 5, 2019. This conference was supported by Korean Institute of Communications and Information Sciences (KICS) and technically cosponsored by the IEEE Communication Society and IEICE Communication Society.

## 2. Organization

The organizing committee of ICUFN 2019 was formed with the Honorary Conference Chairs, Noel Crespi (Institut Mines-Télécom, France), Ilyoung Chong (HUFS, Korea), Sungchang Lee (Aerospace Univ., Korea), Pascal Lorenz (Univ. of Haute Alsace, France), and Seung Ku Hwang (ETRI, Korea), and the Organizing Chairs, Seong-Ho Jeong (HUFS, Korea), Takeo Fujii (Univ. of Electro-Comms, Japan), Won Cheol Lee (Soongsil Univ., Korea), Mislav Grgic (Univ. of Zagreb, Croatia), Zary Segall (KTH, Sweden), and Zdenek Becvar (Czech Technical Univ. in Prague, Czech).



Fig. 1 Opening speech by Prof. Pascal Lorenz (Univ. of Haute Alsace, France).

The technical program was organized by Technical Program Committee Chairs, Dongkyun Kim (Kyungpook National Univ., Korea), Xin WANG (Fudan Univ., China), Insoo Sohn (Dongguk Univ., Korea), Suguru Kameda (Tohoku Univ., Japan), Kun Yang (Univ. of Essex, UK), Lingyang Song (Peking Univ. China), and Periklis Chatzimisios (ATEITHE, Greece). More than 200 technical program committee (TPC) members were involved in the review process.

## 3. Conference Program

The conference consists of one opening session, one keynote speech, two tutorials, and 32 technical sessions. The opening session started with a brief introduction by Prof. Seong-Ho Jeong (OC Co-Chair), followed by one tutorial entitled “Machine Learning based Data Analysis” and three welcome addresses by Prof. Yeong Min Jang (President of KICS), Prof. Mislav Grgic (Univ. of Zagreb, OC Co-Chair), and Prof. Pascal Lorenz (Univ. of Haute Alsace, France).



Fig. 2 After the opening event.

After that, one keynote speech entitled “Empowering Data Technology to AI-based Affective Computing” from Prof. Ilyoung Chong (HUFS) was delivered. The accepted technical papers were organized into 26 oral and 6 poster sessions. We also had 5 workshops focusing on the latest trends in various technologies. There were approximately 300 participants from more than 30 countries of the world, such as Korea, China, Japan, Taiwan, United Kingdom, UAE, France, Germany, Italy, Canada, USA, and so on. The program covers a variety of topics on wireless and wired communication and networking technologies including cognitive radios, wireless sensor networks, Internet of Things (IoT), broadband wireless communications, future network issues, mobile multimedia networking, Big data, machine learning, cloud computing, and other important technologies.

The Welcome Reception and Banquet were held at Sheraton Zagreb Hotel. At the welcome reception, Prof. Sungchang Lee (Korea Aerospace Univ., Korea) welcomed participants. At the banquet, Prof. Pascal Lorenz (University of Haute Alsace, France) delivered a welcome speech. Furthermore, Prof. Yeong Min Jang (Kookmin Univ., Korea, SC Chair of ICUFN 2019) provided a possible venue for ICUFN 2020. The best &

excellent paper award ceremony was held simultaneously during the banquet session.

- Best & Excellent Paper Awards
  - “Infrared Indoor Positioning Using Invisible Beacon,” Willy Anugrah Cahyadi (Telkom University Bandung, Indonesia), Yeon Ho Chung (Pukyong National University, Korea), Trio Adiono (Institut Teknologi Bandung, Indonesia)
  - “An attempt at introducing Multipath in QUIC,” Alessandro Celestino and Simon Pietro Romano (Universit`a degli Studi di Napoli Federico II, Napoli, Italy)
  - “Mitigating Data Integrity Attacks in Building Automation Systems Using Denoising Autoencoders,” Caezarina Marie Calimbahin, Susan Pancho-Festin and Jhoanna Rhodette Pedrasa (University of the Philippines, Philippines)
  - “A high-speed key management method for quantum key distribution network,” Ririka Takahashi, Yoshimichi Tanizawa and Alexander Dixon (Toshiba Corporation, Japan)

#### **4. Conclusion**

We believe that ICUFN 2019 was a truly successful conference in the area of communications and networking. On behalf of the organizing committee, we would like to thank our sponsors, KICS, IEEE Communications Society, and IEICE Communication Society for their kind and generous support to this successful event. In addition, it is our pleasure to announce that ICUFN 2020 will be held in Porto, Portugal, June 30 (Tue.) ~ July 3 (Fri.), 2020 (for more details, please visit <http://www.icufn.org/>).



## IEICE-CS Related Conferences Calendar

Date	Conference Name	Location	Note
26 Oct. – 30 Oct. 2020	2020 International Symposium on Antennas and Propagation ( <b>ISAP2020</b> )	Osaka, Japan	Submission deadline: 24 Apr. 2020
7 Jun. – 11 Jun. 2020	Information-centric Networking Solutions for Real-world Applications ( <b>ICN-SRA</b> )	Dublin, Ireland	Submission deadline: 20 Jan. 2020
20 May – 22 May 2020	The 14 <sup>th</sup> International Symposium on Medical Information and Communication Technology ( <b>ISMICT 2020</b> )	Nara, Japan	Submission deadline: 15 Dec. 2019
19 Feb. – 21 Feb. 2020	2020 International Conference on Artificial Intelligence in Information and Communication ( <b>ICAIIIC 2020</b> )	Fukuoka, Japan	To be held <b>soon</b>
7 Jan. – 10 Jan. 2020	The 34 <sup>th</sup> International Conference on Information Networking ( <b>ICOIN 2020</b> )	Barcelona, Spain	To be held <b>soon</b>
9 Dec. – 11 Dec. 2019	7 <sup>th</sup> International Conference on Smart Grid ( <b>icSmartGrid 2019</b> )	Newcastle, Australia	To be held <b>soon</b>
6 Nov. – 8 Nov. 2019	The 25 <sup>th</sup> Asia-Pacific Conference on Communications ( <b>APCC2019</b> )	Ho Chi Minh, Vietnam	Done
3 Nov. – 6 Nov. 2019	International Conference on Renewable Energy Research and Applications ( <b>ICRERA2019</b> )	Brasov, Romania	Done
29 Oct. – 1 Nov. 2019	The 37 <sup>th</sup> International Communications Satellite Systems Conference ( <b>37<sup>th</sup> ICSSC</b> ),	Okinawa, Japan	Done
27 Oct. – 30 Oct. 2019	2019 International Symposium on Antennas and Propagation ( <b>ISAP2019</b> )	Xi'an, China	Done
16 Oct. – 18 Oct. 2019	International Conference on Information and Communication Technology Convergence 2019 ( <b>ICTC2019</b> )	Jeju Island, Korea	Done
22 Sep. 2019	Technology Trials and Proof-of-Concept Activities for 5G Evolution & Beyond 2019 ( <b>TPoC5GE 2019</b> )	Honolulu, USA	<b>Reported</b> on this issue
18 Sep. – 20 Sep. 2019	Asia-Pacific Network Operations and Management Symposium ( <b>APNOMS 2019</b> )	Matsue, Japan	<b>Reported</b> on this issue
5 Aug. – 8 Aug. 2019	Japan-China Workshop on the Next Generation Mobile Communication Technology and Application 2019	Harbin, China	<b>Reported</b> on this issue
5 Aug. – 8 Aug. 2019	The 18 <sup>th</sup> International Workshop on Assurance in Distributed Systems and Networks ( <b>ADSN 2019</b> )	Fukuoka, Japan	<b>Reported</b> on this issue
28 Jul. – 2 Aug. 2019	IEEE International Geoscience and Remote Sensing Symposium 2019 ( <b>IGARSS 2019</b> )	Yokohama, Japan	<b>Reported</b> on this issue
7 Jul. – 11 Jul. 2019	The 24 <sup>th</sup> Opto-Electronics and Communications Conference / International Conference on Photonics in Switching and Computing 2019 ( <b>OECC / PSC2019</b> )	Fukuoka, Japan	<b>Reported</b> on this issue

Date	Conference Name	Location	Note
2 Jul. – 5 Jul. 2019	International Conference on Ubiquitous and Future Networks 2019 ( <b>ICFUN2019</b> )	Zagreb, Croatia	<b>Reported</b> on this issue
3 Jun. – 7 Jun. 2019	2019 Joint International Symposium on Electromagnetic Compatibility and Asia-Pacific International Symposium on Electromagnetic Compatibility, Sapporo ( <b>EMC Sapporo &amp; APEMC 2019</b> )	Sapporo, Japan	<b>Reported</b> on this issue

Please confirm with the following IEICE-CS web site for the latest information.

<http://www.ieice.org/cs/conf/calendar.html>



# ISAP2020

## Call for Papers

### 2020 INTERNATIONAL SYMPOSIUM ON ANTENNAS AND PROPAGATION October 26-30, 2020, Osaka, JAPAN

The 2020 International Symposium on Antennas and Propagation (ISAP2020) will be held at Knowledge Capital Congrès Convention Center in Osaka, Japan, from October 26 (Monday) through 30 (Friday), 2020. This Symposium, the 25th ISAP, is sponsored and organized by the Communications Society of the Institute of Electronics, Information and Communication Engineers (IEICE), and is expected to be technically co-sponsored by the Antenna Measurement Techniques Association (AMTA), the Antennas and Propagation Society of the Institute of Electrical and Electronics Engineers (IEEE/AP-S), the Antennas Society of the Chinese Institute of Electronics (AS-CIE), the Electrical Engineering/Electronics, Computer, Communications, Information Technology Association of Thailand (ECTI), the European Association on Antennas and Propagation (EurAAP), the Institute of Antenna Engineers of Taiwan, the Korean Institute of Electromagnetic Engineering and Science (KIEES), and the Taiwan Microwave Association.

#### VENUE

Osaka is located on the main island of Honshu, roughly in the center of Japan. Once known as the Nation's Kitchen, Osaka still holds the title of Food Capital of Japan. Osaka provides a lot of shopping sites with an irresistible experience. The historical capital city of Kyoto, and Nara, an ancient city with numerous World Heritage sites, are all accessible in less than 40 minutes from Osaka.

Knowledge Capital Congrès Convention Center is directly linked via a connecting walkway to JR Osaka Station, the hub of the Kansai rail network.



#### OBJECTIVE

ISAP2020 is intended to provide an international forum for the exchange of information on the progress of research and development in antennas, propagation, electromagnetic-wave theory, and related fields as shown in the SCOPE. It is also an important objective of this meeting to promote mutual interaction among participants.

#### SCOPE

This symposium will treat a wide range of subjects on antennas, propagation and electromagnetic-wave theory as suggested below. Papers concerned with other aspects of these subjects will also be considered. In addition, special topics treating emerging technologies heralding a new era in wireless communications and applications are invited for consideration.

#### A. Antennas

- A1. Small Antennas and RF Sensors
- A2. Antennas for Mobile and V2X Applications
- A3. Broadband and Multi-band Antennas
- A4. Active, Adaptive, On-Chip and Smart Antennas
- A5. Tunable and Reconfigurable Antennas
- A6. Planar/Printed Antennas and Arrays
- A7. Antenna Theory and Design
- A8. Antenna Measurements
- A9. Millimeter-wave, Terahertz and Optical Antennas
- A10. Metamaterials and Metasurfaces for Antennas

#### B. Propagation

- B1. Indoor and Mobile Propagation
- B2. Millimeter-wave, THz and Optical Propagation
- B3. Propagation for V2X and IoT
- B4. Channel Sounding and Channel Estimation
- B5. Radar, DOA, localization and Sensing
- B6. Remote Sensing
- B7. Terrestrial, Earth-Space and Ionospheric Propagation
- B8. Propagation Fundamentals
- B9. Propagation Measurement Techniques

#### C. Electromagnetic-wave Theory

- C1. Computational Electromagnetics
- C2. Time-Domain Techniques
- C3. Scattering, Diffraction and RCS
- C4. Inverse and Imaging Techniques
- C5. Optimization Methods in EM Problems
- C6. Passive and Active Components
- C7. Frequency Selective Surfaces and Filters
- C8. EBG, Metamaterials and Periodic Structures
- C9. Multiscale and Multiphysics Techniques

#### D. AP-related Topics

- D1. Antenna Systems for Mobile Communications
- D2. MIMO and Array Signal Processing
- D3. AP Related Topics for 5G and Beyond
- D4. Wireless Power Transfer Technologies
- D5. Wearable Device Networks and Medical Applications
- D6. OAM and Near Field Communications
- D7. RFID and Its Applications
- D8. EMC/EMI Technologies

#### IMPORTANT DATES

Deadline for paper submission: April 24, 2020  
 Notification of accepted papers: June 26, 2020  
 Deadline for early registration: August 31, 2020



## PREPARATION OF PAPERS

Original papers are solicited that have not been presented previously and that describe new contributions in the area suggested in the SCOPE. Each author is requested to prepare a 2-page camera-ready paper in 2-column format written in English, including all text, references, figures and photographs. The authors are requested to refer to the ISAP2020 Web page (<http://www.isap2020.org/>) for the detailed paper preparation instructions and the IEICE Copyright Transfer Form.

## SUBMISSION OF PAPERS

Authors are requested to send their papers in IEEE Xplore-compliant PDF format electronically. Presented papers of ISAP2020 are planned to be included in ISAP Archives and IEEE Xplore.

## WORKSHOP

Several workshops are scheduled to be held on October 26 (Monday), 2020.

## AWARDS

Several outstanding papers will be awarded for ISAP2020 Paper Awards. ISAP2020 also hosts Student Paper Awards in order to foster activities of students toward highly qualified researchers.

## STUDENT DESIGN CONTEST

Student Design Contest (SDC) will be held for the first time in the history of ISAPs during the ISAP2020. The aim of ISAP SDC is to promote student innovation and creative activities in antennas, propagation, and the related research fields. The following three contest categories are prepared; A. Antenna Design, B. Localization of RF Sources, and C. EM Analysis and Observation Competition. Excellent designs will be awarded at the buffet party of the ISAP2020 and will receive cash awards! Detailed information will be announced at the ISAP2020 SDC Web page: <http://www.isap2020.org/sdc.html>

## SPECIAL SECTION ON IEICE TRANS.

The Special Section on ISAP2020 will be planned in the IEICE Transactions on Communications.

## ISAP ARCHIVES

ISAP Archives currently opens as a trial service. You can search and read the conference papers from the ISAP1971 to 2016 at the ISAP Archives Web page: [http://www.ieice.org/cs/isap/ISAP\\_Archives/index.html](http://www.ieice.org/cs/isap/ISAP_Archives/index.html)

## EXHIBITION

Spaces for demonstration of software, books and products are also available with charge.

## WIE (WOMEN IN ENGINEERING)

It is our pleasure to inform that ISAP2020 will launch WIE. WIE is providing opportunities to make global networks and collaboration for ALL ISAP2020 PARTICIPANTS through special sessions and lunchtime events. The detailed information of ISAP2020 WIE will announce in the next CFP and Web site. Our understanding and cooperation will develop AP technologies and community!

## STEERING COMMITTEE

Chairperson	H. Arai (Yokohama National Univ.)
Vice Co-Chairs	H. Iwai (Doshisha Univ.) J. Hirokawa (Tokyo Institute of Tech.) M. Takahashi (Chiba Univ.)
Secretaries	K. Nishimori (Niigata Univ.) N. Michishita (National Defense Academy)
Technical Program	H. Yamada (Niigata Univ.)
Student Contest	T. Takahashi (Mitsubishi Electric)
Registration	T. Sasamori (Hokkai-Gakuen Univ.)
Local Arrangement	M. Fujimoto (Univ. of Fukui)
Social Program	R. Yamaguchi (Softbank)
Exhibition	S. Hori (Kojima Industries)
International Advisory	Q. Chen (Tohoku Univ.) K. Cho (Chiba Institute of Tech.)
Finance	H. Tsuji (NICT) N. Ishii (Niigata Univ.)
Women in Engineering	M. Matsunaga (Tokyo Univ. of Tech.)



Contact E-mail: [ap\\_ac-isap2020@mail.ieice.org](mailto:ap_ac-isap2020@mail.ieice.org)

Sponsored and organized by:

The Communications Society of the Institute of Electronics, Information and Communication Engineers (IEICE)

Co-sponsored by:

The Antenna Measurement Techniques Association (AMTA), The Antennas and Propagation Society of the Institute of Electrical and Electronics Engineers (IEEE/AP-S), The Antennas Society of the Chinese Institute of Electronics (AS-CIE), The Electrical Engineering/Electronics, Computer, Communications, Information Technology Association of Thailand (ECTI), The European Association on Antennas and Propagation (EurAAP), The Institute of Antenna Engineers of Taiwan, The Korean Institute of Electromagnetic Engineering and Science (KIEES), and The Taiwan Microwave Association.

Further information can be found on the Website ► ISAP2020 Web Page : <http://www.isap2020.org>



## ISMICT 2020 - 14th IEEE International Symposium on Medical Information Communication Technology Nara, Japan, 20-22 May, 2020

### Call for Papers

The 14th International Symposium on Medical Information Communication Technology, ISMICT 2020, aims to establish a forum to present new research and development results, exchange ideas, discuss practices, and share experiences among Technology and Medicine sides, including healthcare, wellness, clinical therapy, and surgery, as well as ICT, mechanical, and biomedical engineering. Moreover, activities of standard, regulation and business for medical ICT devices, systems and services will be promoted by national and international government and industry.

ISMICT 2020 will be held in Nara Kasugano International Forum 葦原 IRAKA, 20-22 May 2020. Papers are invited on topics including, but not limited to, the following:

- Communication systems for medical applications
- Body area network (BAN) technologies
- Privacy and security issues
- Wearable and implantable devices
- Wellness and sports training
- Medical device regulatory science
- Pervasive health care and patient monitoring
- Antennas and radio propagation for Wireless BAN
- Internet of Medical Things
- AI/data analytics for medicine, healthcare and welfare

Authors are invited to submit full papers of 4-6 pages. The review process is according to the IEEE regulations and accepted papers will be included in the IEEE Xplore.

**More information at: [www.ismict2020.org](http://www.ismict2020.org)**

### Important Dates

**Paper submission deadline: 15th December 2019**

**Acceptance notification: 17th February 2020**

**Camera-ready paper due: 31st March 2020**

### Organization

#### General Co-Chairs:

Prof. Minoru Okada, Japan

Prof. Shinsuke Hara, Japan

#### TPC Co-Chairs:

Prof. Tetsushi Ikegami, Japan

Prof. Sintarou Izumi, Japan

Prof. Hiroyuki Yomo, Japan

#### Steering Committee Co-Chairs:

Prof. Ryuji Kohno, Japan

Prof. Jari Linatti, Finland

Prof. Matti Hämäläinen, Finland

#### Workshop & Special Session Co-Chairs:

Prof. Takahiro Aoyagi, Japan

Prof. Eisuke Hanada, Japan

#### Publicity Co-Chairs:

Prof. Takumi Kobayashi, Japan

Dr. Huan-Bang Li, Japan

Prof. Kohei Ohno, Japan

#### Publication Co-Chairs:

Prof. Minseok Kim, Japan

Prof. Chika Sugimoto, Japan

#### Finance Co-Chairs:

Dr. Teruo Onishi, Japan

Prof. Hirokazu Tanaka, Japan

#### Local Arrangement Co-Chairs:

Prof. Manato Fujimoto, Japan

Prof. Takeshi Higashino, Japan

#### Secretary:

Prof. Daisuke Anzai, Japan

Technically co-sponsored by





IEEE International Conference on Communications  
7-11 June 2020 // Dublin, Ireland  
Communications Enabling Shared Understanding

## WS-09: WORKSHOP ON INFORMATION-CENTRIC NETWORKING SOLUTIONS FOR REAL-WORLD APPLICATIONS (ICN-SRA)

### CALL FOR PAPERS

Internet applications have evolved from the direct end-to-end data delivery model represented by applications like telnet to an information-centric usage model represented by applications ranging from virtual and augmented reality to data collection from large scale IoT deployment. Such a dramatic shift in application patterns is particularly challenging to the existing IP model given the mismatch between IP's host-centric approach to networking and the content-centric approach embraced by applications today. Furthermore, the recently reported serious security incidents in the Internet expose serious architectural deficiency in the deployed Internet.

The Information-Centric Networking (ICN) paradigm and its realization through Named Data Networking (NDN) have emerged in recent years with the promise of providing efficient, resilient and secure communication services for today's and future applications. ICN/NDN has evolved from the basic research phase to the applied research and trial deployment phase to address real world problems including industrial control systems, Internet of Things (IoT), scientific applications, as well as tactical network environments. The core building blocks of ICN/NDN include application-defined hierarchical naming, built-in security support, and stateful forwarding which enables network intelligence, native support for multicast and scalable content dissemination. These ICN/NDN features enable more efficient and secure communication, better resilience to challenging network dynamics, while improving latency and data delivery.

The objective of this workshop is to highlight recent research, development, and evaluation of ICN/NDN in real world applications as well as stimulate more discussions in this area. The workshop has a particular interest in real world applications of ICN/NDN in challenging communication environments, where IP-based solutions are excessively complex or simply do not work. This workshop will offer a venue for researchers from both industry and academia to demonstrate their recent progress in applying ICN/NDN in this problem space as well as identify potential opportunities and research gaps.

### TOPICS OF INTEREST

Original papers are welcome on (but not limited to) experimental validation of Information Centric Networking/Named Data Networking solutions for the following real world applications:

- ICN/NDN applications for Internet-of-Things
- ICN/NDN applications for smart vehicles
- ICN/NDN applications for smart cities
- ICN/NDN applications in space communications
- ICN/NDN for 5G networking
- ICN/NDN support for mobile applications
- ICN/NDN for social networking applications
- ICN/NDN support for real-time audio and video applications
- ICN/NDN for edge computing
- ICN/NDN applications in disaster scenarios and contested environments
- ICN/NDN application QoS-aware functionalities in challenged communication environments
- ICN/NDN applications in support of blockchain technologies
- Trial deployment and casestudies of ICN/NDN
- Modeling, analysis and characterization of ICN/NDN functionalities in challenged communication network

### IMPORTANT DATES

- Deadline for paper submission: January 20, 2020
- Acceptance/rejection announcement: February 20, 2020
- Final workshop papers due: March 1, 2020



## Special Section Calendar of IEICE Transactions on Communications

Issue	Special Section	Note
Apr. 2021	No special section this issue	
Mar. 2021	Network Virtualization/Softwarization and Artificial Intelligence towards Beyond-5G Innovative IoT Services	Submission due: 12 April 2020
Feb. 2021	No special section this issue	
Jan. 2021	No special section this issue	
Dec. 2020	IoT Sensor Networks and Mobile Intelligence	Submission due: 10 January 2020
Nov. 2020	Opto-electronics and Communications for Future Optical Network	Submission due: 20 December 2019
Oct. 2020	New Era of Satellite Communication / Broadcasting / Application Technologies	To be issued
Sep. 2020	Electromagnetic Compatibility in Conjunction with EMC Sapporo and APEMC 2019	To be issued
Aug. 2020	No special section this issue	
Jul. 2020	No special section this issue	
Jun. 2020	Information and Communication Technology for IoT/CPS in Medicine and Healthcare	To be issued
May 2020	No special section this issue	
Apr. 2020	Network Resource Control and Management Technologies for Sustainable Social Information Infrastructure	To be issued
Mar. 2020	No special section this issue	
Feb. 2020	No special section this issue	
Jan. 2020	Internet Architecture, Applications and Operation Technologies for a Cyber-Physical System	To be issued
Dec. 2019	No special section this issue	
Nov. 2019	No special section this issue	
Oct. 2019	Exploring Drone for Mobile Sensing, Coverage and Communications: Theory and Applications	Vol. E102-B, No. 10

Please confirm with the following IEICE web site for the latest CALL FOR PAPERS  
<http://www.ieice.org/event/ronbun-e.php?society=cs>

----- Joint Special Section on Opto-electronics and Communications for Future Optical Network -----

The IEICE Transactions on Communications announces that it will publish a special section entitled "Joint Special Section on Opto-electronics and Communications for Future Optical Network" in the **November 2020** issue.

This Special Section will be published in conjunction with the 24th Optoelectronics and Communications Conference (OECC 2019), which was held in Fukuoka, Japan on July 7 – July 11, 2019, cosponsored by IEICE Communications Society and IEICE Electronics Society and co-organized with International Conference on Photonics in switching and computing 2019 (PSC2019).

The purpose of this Special Section is to present a collection of original papers that give an overview of current progress of research, development, and applications of optical communication systems and optoelectronics.

Submission of the paper presented at OECC/PSC 2019 is strongly encouraged. However, presentation of the paper at OECC/PSC 2019 is not mandatory for its inclusion in this Special Section. Presentation at the Conference does not ensure the acceptance of the paper. Note that the regular reviewing process will be performed for this Special Section.

## 1. Scope

The major topics of interest include:

- Core/Access/Data Center Networks and Subsystems (O1)
- Transmission Systems and Subsystems (O2)
- Optical Fibers, Cables and Fiber Devices (O3)
- Optical Active Devices and Modules (O4)
- Optical Passive Devices and Modules (O5)
- Photonics in Switching Technologies, Systems, and Architectures for Communications and Networking (P1)
- Photonics in Switching Technologies, Systems, and Architectures for Computing and Big Data (P2)

Papers in categories O1, O2, O3, P1 and P2 should be submitted to The IEICE Transactions on Communications, and papers in categories O4 and O5 to The IEICE Transactions on Electronics.

## 2. Submission Instructions

The standard number of pages is 8. The page charges are considerably higher for extra pages. Manuscripts should be prepared according to the guideline in the "Information for Authors". The latest version is available at the web site, [http://www.ieice.org/eng/shiori/mokuji\\_cs.html](http://www.ieice.org/eng/shiori/mokuji_cs.html) (IEICE Transactions on Communications), [http://www.ieice.org/eng/shiori/mokuji\\_es.html](http://www.ieice.org/eng/shiori/mokuji_es.html) (IEICE Transactions on Electronics). The term for revising the manuscript after acknowledgement of conditional acceptance for this special section could be shorter than that for regular issues (60 days) because of the tight review schedule.

This special section will accept papers only by electronic submission. Submit a manuscript and electronic source files (TeX/Word files, figures, authors' photos and biographies) via the IEICE Web site [https://review.ieice.org/regist/regist\\_baseinfo\\_e.aspx](https://review.ieice.org/regist/regist_baseinfo_e.aspx) **by December 20, 2019 (Japan Time)**. Considering the technical field of the paper, authors should choose either Opto-electronics and Communications for Future Optical Network of IEICE Transactions on Communications (Special-OB) or Opto-electronics and Communications for Future Optical Network of IEICE Transactions on Electronics (Special-OC) as a "Journal / Section" on the online screen. Do not choose [Regular-EB] or [Regular-EC].

### Contact points:

Takayuki Kobayashi

NTT Corporation.

Tel: +81 46 859 4373

Email: [eb-oeccpsc2019@mail.ieice.org](mailto:eb-oeccpsc2019@mail.ieice.org)

Keita Mochizuki

Mitsubishi Electric.

Tel: +81 467 41 2906

E-mail: [ec-oeccpsc2019@ieice.org](mailto:ec-oeccpsc2019@ieice.org)

## 3. Special Section Editorial Committee

### Opto-electronics and Communications for Future Optical Network of IEICE Transactions on Communications

**Guest Editor-in-Chief:** Yutaka Miyamoto (NTT)

**Guest Editors:** Takayuki Kobayashi (NTT), Kazuhiko Aikawa (Fujikura)

**Guest Associate Editors:** Kota Asaka (NTT), Noboru Yoshikane (KDDI Research), Takeshi Hoshida (Fujitsu Labs.), Kazuhide Nakajima (NTT), Tsuyoshi Konishi (Osaka Univ.), Hideki Tode (Osaka Pref. Univ.)

### Opto-electronics and Communications for Future Optical Network of IEICE Transactions on Electronics

**Guest Editor-in-Chief:** Hiroshi Aruga (Mitsubishi Electric)

**Guest Editor:** Keita Mochizuki (Mitsubishi Electric)

**Guest Associate Editors:** Nobuhiko Nishiyama (Tokyo Tech), Koji Yamada (AIST), Hideki Yagi (Sumitomo Electric), Yuya Shoji (Tokyo Tech), Naoya Kono (Sumitomo Electric)

\* Authors must agree to the "Copyright Transfer and Page Charge Agreement" via electronic submission.

\* Upon accepted for publication, all authors, including authors of invited papers, should pay the page charges covering the partial cost of publication around April 2020. For detailed information, please visit [http://www.ieice.org/eng/shiori/page2\\_cs.html#5](http://www.ieice.org/eng/shiori/page2_cs.html#5)

\* At least one of the authors must be an IEICE member when the manuscript is submitted for review. Invited papers are an exception. We recommend that authors unaffiliated with IEICE apply for membership. For membership applications, please visit <http://www.ieice.org/eng/join/member.html>

\* The accepted papers for IEICE Transactions on Communications will be published online soon on the web site of Transactions Online after the payment of page charges has been completed. For detailed information, please visit [http://www.ieice.org/eng/shiori/page2\\_cs.html#8](http://www.ieice.org/eng/shiori/page2_cs.html#8)

----- Special Section on IoT Sensor Networks and Mobile Intelligence -----

The IEICE Transactions on Communications announces that it will publish a special section entitled "Special Section on IoT Sensor Networks and Mobile Intelligence" in the **December 2020** issue.

In addition to ubiquitous sensor networks and mobile networks that support the Internet of Things (IoT) era, the research and development area of "mobile sensors" is growing. In detail, in addition to research and development on sensor technologies, mobility technologies, including connected cars, unmanned aerial vehicle (UAV), wearable technologies, and robots, and mobile ubiquitous computing that extracting valuable knowledge from collected sensor data are growing. Also, applications related to the ambient intelligence cooperated with sensing, mobility, and computing technologies through networking technology are important. Thus, research has been promoted to develop fundamental technologies including sensing, wireless networking, data analysis, and processing technologies as well as industrial applications that support ambient intelligence. The technical committee on Ambient Intelligence and Sensor Networks (ASN) and the technical committee on Mobile Network and Applications (MoNA), the predecessor of the technical committee on Sensor Networks and Mobile Intelligence (SeMI), planned symposium on "Ambient Intelligence and Sensor Networks Supporting Smart Mobility: Cars and Drone as Mobility in the IoT Era" in 2017 and symposium on "Sensor Networks and Mobile Intelligence Supporting Smart Society" to create new technologies and promote research activities in various application fields.

Because of such reasons, a special section is being planned (scheduled to appear in the December 2020 issue) to further promote research and development of the ambient intelligence with sensor networks and mobile sensors that support the IoT era.

### 1. Scope

This special section aims at timely dissemination of research in these areas. Possible topics include, but are not limited to:

- [Sensing] Mobile sensing/sensor, sensing device, embedded device, image and acoustic sensing, environment sensing, vital sensing, power/energy saving, battery-less, energy harvesting
- [Mobility] Connected car, drone, wearable, mobility management, robots, automated driving/driver assist technology, mobile security, behavior recognition, estimation, prediction, and control
- [Mobile/ubiquitous computing] Edge/fog/cloud, machine learning, sensor fusion, database, cyber physical and intelligent environment, swarm intelligence, sensor and mobile data analysis/processing
- [Sensor/adhoc/mobile networks] IoT/IoE, network virtualization, M2M/D2D, V2V/V2I/V2X, content delivery network, software defined networks, information/content centric network, architecture and protocols
- [Applications] Smart mobility/ITS, VR/AR/game, people-flow analysis/control, medical/healthcare/sports/education assist, smart city, smart house, smart factory, disaster prevention and reduction, construction/agriculture/forestry/fisheries assist

### 2. Submission Instructions

The standard number of pages is 8. The page charges are considerably higher for extra pages. Manuscripts should be prepared according to the guideline in the "Information for Authors." The latest version is available at the web site, [http://www.ieice.org/eng/shiori/mokuji\\_cs.html](http://www.ieice.org/eng/shiori/mokuji_cs.html). The term for revising the manuscript after acknowledgement of conditional acceptance for this special section could be shorter than that for regular issues (60 days) because of the tight review schedule.

This special section will accept papers only by electronic submission. Submit a manuscript and electronic source files (LaTeX/Word files, figures, authors' photos and biographies) via the IEICE Web site [https://review.ieice.org/regist/regist\\_baseinfo\\_e.aspx](https://review.ieice.org/regist/regist_baseinfo_e.aspx) by **January 10, 2020 (JST)**. Authors should choose the Special Section on IoT Sensor Networks and Mobile Intelligence as a "Journal/Section" on the online screen. Do not choose [Regular EB].

**Contact point:**  
**Tomoyuki Ohta**  
**Hiroshima City University**  
**Tel: +81-82-830-1573, E-mail: semi-trans2020-sec@mail.ieice.org**

### 3. Special Section Editorial Committee

**Guest Editor-in-Chief:** Susumu Ishihara (Shizuoka Univ.)

**Guest Editors:** Koji Yamamoto (Kyoto Univ.), Tomoyuki Ohta (Hiroshima City Univ.)

**Guest Associate Editors:** Miyuki Imada (NTT), Chikara Ohta (Kobe Univ.), Kenya Sato (Doshisha Univ.), Hiroo Sekiya (Chiba Univ.), Shigeaki Tagashira (Kansai Univ.), Katsuhiko Naito (Aichi Institute of Technology), Jin Nakazawa (Keio Univ.), Kanae Matsui (Tokyo Denki Univ.)

\* Authors must agree to the "Copyright Transfer and Page Charge Agreement" via electronic submission.

\* Upon accepted for publication, all authors, including authors of invited papers, should pay the page charges covering the partial cost of publication around May 2020. For detailed information, please visit [http://www.ieice.org/eng/shiori/page2\\_cs.html#5](http://www.ieice.org/eng/shiori/page2_cs.html#5)

\* At least one of the authors must be an IEICE member when the manuscript is submitted for review. Invited papers are an exception. We recommend that authors unaffiliated with IEICE apply for membership. For membership applications, please visit <http://www.ieice.org/eng/join/member.html>

\* The accepted papers will be published online soon on the web site of Transactions Online after the payment of page charges has been completed. For detailed information, please visit [http://www.ieice.org/eng/shiori/page2\\_cs.html#8](http://www.ieice.org/eng/shiori/page2_cs.html#8)



## Call for Papers

# ----- Special Section on Fusion of Network Virtualization/Softwarization and Artificial Intelligence towards Beyond-5G Innovative IoT Services -----

The IEICE Transactions on Communications announces that it will publish a special section entitled "Special Section on Fusion of Network virtualization/Softwarization and Artificial Intelligence towards Beyond-5G Innovative IoT Services" in **March 2021**.

5G is reaching the stage of realization and ultra-high speed mobile broadband, ultra-low latency in communications, and accommodation of massive IoT devices lay the groundwork for innovative IoT services. On the other hand, towards Beyond-5G era, requirements for more reliable, flexible, and robust ICT (Information and Communication Technologies) systems are emerging and pose new challenges.

Advanced technologies for network virtualization and softwarization are expected to provide flexibility to satisfy a wide variety of customer demands, scalability to expand in accordance with the increase of demands, efficiency in resource usage even under scarce and heterogeneous environment, and sustainability to involve new functionalities and technologies in an incremental manner for service continuity. However, rapid progress needs to be made to tackle such new challenges. In particular, fusion with AI (Artificial Intelligence) attracts great attention.

We thus call for publications (scheduled to appear in the March 2021 issue) for promoting discussion and development of network virtualization and softwarization based on the fusion with Artificial Intelligence towards Beyond-5G innovative IoT services, especially on architectural examination, resource management and control approaches, mobile and wireless network virtualization, edge computing, open-source software, and so forth.

## 1. Scope

This special section aims at timely dissemination of research in these areas. Possible topics include, but are not limited to:

- AI-based network management and control in network virtualization
- Mobile and wireless network virtualization and its related mobility technologies
- Edge computing for Beyond 5G services
- Photonic network virtualization
- Management of massive IoT devices
- Security for network virtualization and secure services
- Innovative applications based on network virtualization
- Network softwarization and open-source software
- Testbeds for above technologies and experimental results

## 2. Submission Instructions

The standard number of pages is 8. The page charges are considerably higher for extra pages. Manuscripts should be prepared according to the guideline in the "Information for Authors". The latest version is available at the web site, [https://www.ieice.org/eng/shiori/mokuji\\_cs.html](https://www.ieice.org/eng/shiori/mokuji_cs.html). The period for revising the manuscript after acknowledgement of conditional acceptance for this special section could be shorter than that for regular issues (60 days) because of the tight review schedule.

This special section will accept papers only by electronic submission. Submit a manuscript and electronic source files (LaTeX/Word files, figures, authors' photos and biography) via the IEICE Web site [https://review.ieice.org/regist/regist\\_baseinfo\\_e.aspx](https://review.ieice.org/regist/regist_baseinfo_e.aspx) by **April 12th, 2020 (JST)**. Authors should choose the Fusion of Network virtualization/Softwarization and Artificial Intelligence towards Beyond-5G Innovative IoT Services as a "Journal/Section" on the online screen. Do not choose [Regular-EB].

### Contact point:

**Kiyohide Nakauchi**  
**Social-ICT System Laboratory, ICT Testbed Research and Development Promotion Center,**  
**National Institute of Information and Communications Technology (NICT).**  
**Tel: +81-42-327-5403, Email: [nv+eb2021@mail.ieice.org](mailto:nv+eb2021@mail.ieice.org)**

## 3. Special Section Editorial Committee

**Guest Editor-in-Chief:** Hiroaki Harai (NICT)

**Guest Editors:** Dai Suzuki (Fujitsu Laboratories), Kiyohide Nakauchi (NICT)

**Guest Associate Editors:** Masaki Aida (Tokyo Metropolitan Univ.), Toru Hasegawa (Osaka Univ.), Yohei Hasegawa (NEC), Katsuyoshi Iida (Hokkaido Univ.), Yoshinori Kitatsuji (KDDI Research), Fumio Teraoka (Keio Univ.), Atsuko Takefusa (NII)

\*Authors must agree to the "Copyright Transfer and Page Charge Agreement" via electric submission.

\*Upon accepted for publication, all authors, including authors of invited papers, should pay the page charges covering the partial cost of publication around September 2020. For detailed information, please visit [https://www.ieice.org/eng/shiori/page2\\_cs.html#5](https://www.ieice.org/eng/shiori/page2_cs.html#5)

\*At least one of the authors must be an IEICE member when the manuscript is submitted for review. Invited papers are an exception. We recommend that authors unaffiliated with IEICE apply for membership. For membership applications, please visit the web-page, <https://www.ieice.org/eng/join/member.html>.

\*The accepted papers will be published online soon after notification of acceptance on the web site of Transactions Online. For detailed information, please visit [http://www.ieice.org/eng/shiori/page2\\_cs.html#8](http://www.ieice.org/eng/shiori/page2_cs.html#8)

## From Editor's Desk

### ●Season's greetings

I'm Nazuki Honda. In June of this year, I become the Director of Planning and Member Activities of IEICE-CS, and started editing the IEICE-CS CLOBAL NEWSLETTER (GNL). I would like to deliver useful and attractive contents to you. We published GNL four times in 2019. Many thanks to all GNL authors and readers. We hope you have a wonderful holiday and a Happy New Year!

We welcome your contribution of article submissions to GNL. For article submission, please refer to the Submission Guideline of IEICE-CS GLOBAL NEWSLETTER:

[ENG] [http://www.ieice.org/cs/pub/global\\_howto.html](http://www.ieice.org/cs/pub/global_howto.html)

[JPN] [http://www.ieice.org/cs/jpn/pub/global\\_howto.html](http://www.ieice.org/cs/jpn/pub/global_howto.html)

### ●IEICE General Conference 2020 Held in Hiroshima

IEICE General Conference 2020 will be held at Hiroshima University, from 17<sup>th</sup> to 20<sup>th</sup> March 2020. Complete English sessions are also scheduled in the conference.

Please check out the latest conference information on the IEICE web site at:

<https://www.ieice-taikai.jp/2020general/en/index.html>.

IEICE-CS GLOBAL NEWSLETTER Editorial Staff

#### Editorial Staff of this issue

No special order is observed.



**Yohei KOGA**

Fujitsu Connected Technologies, Ltd.  
Platform Development Div.

*Director, Planning and Member Activities, IEICE Communications Society*



**Nazuki HONDA**

Nippon Telegraph and Telephone Corporation  
Access Network Service Systems Laboratories

*Director, Planning and Member Activities, IEICE Communications Society*



**Yoshitaka ENOMOTO**

Nippon Telegraph and Telephone Corporation  
Access Network Service Systems Laboratories

*Director, International Publication, IEICE Communications Society*



# The Institute of Electronics, Information and Communication Engineers (IEICE) Communications Society

## About Communications Society

IEICE Communications Society shall endeavor to facilitate research and investigation activities in the field of communications, and to contribute to research activities through cooperation with other societies, in order to promote the development of science and technology in this field.

### ◆ Technical Committees

Twenty regular technical committees and six ad hoc technical committees carry out research activities. The following is a list of the technical committees.

#### Regular Technical Committees

- Antennas and Propagation (AP)
- Internet Architecture (IA)
- Space, Aeronautical and Navigational Electronics (SANE)
- Satellite Telecommunications (SAT)
- Electromagnetic Compatibility (EMCJ)
- Communication Quality (CQ)
- Information and Communication Management (ICM)
- Information Networks (IN)
- Smart Radio (SR)
- Short Range Wireless Communications (SRW)
- Communication Systems (CS)
- Energy Engineering in Electronics and Communications (EE)
- Network Systems (NS)
- Optical Communication Systems (OCS)
- Optical Fiber Technology (OFT)
- Photonic Network (PN)
- Healthcare and Medical Information Communication Technology (MICT)

- Radio Communication Systems (RCS)
- Wireless Power Transmission (WPT)
- Sensor Network and Mobile Intelligence (SeMI) (Joint committees of ASN/MoNA)

#### Ad Hoc Technical Committees

- Standardization & Innovation in ICT Technologies (SIIT)
- Extremely Advanced Optical Transmission (EXAT)
- Network Virtualization (NV)
- Photonics-applied Electromagnetic Measurement (PEM)
- Information-Centric Networking (ICN)
- Networked Digital Service Platform (DPF)

### ◆ Publications

#### IEICE Transactions on Communication

The IEICE Transactions on Communications (English and Japanese editions) are published monthly.

The impact factor of IEICE Transactions on Communications (English edition) was 1.09 in 2017.

<http://www.ieice.org/cs/jpn/EB/index.html>





## IEICE Communications Express (ComEX)

IEICE Communications Express (ComEX) is an online letter journal, where researchers can exchange new topics easily and in a timely manner.

You can download PDF files from the ComEX site.

<http://www.comex.ieice.org/>



## Magazines

### ➤ GLOBAL NEWSLETTER (GNL)

GLOBAL NEWSLETTER (GNL) exchanges information on global activity between overseas/foreign members and other members in IEICE-CS.

GNL is published every March, June, September, and December.

[http://www.ieice.org/cs/pub/global\\_news.html](http://www.ieice.org/cs/pub/global_news.html)



### ➤ Communications Society Magazine "B-plus"

The Communications Society Magazine (Japanese edition only) "B-plus" provides technical reviews, surveys, practical topics, etc. "B-plus" is published quarterly in Japanese. The electronic version has been accessible free of charge since March 2015.

<http://www.ieice.org/~cs-edit/magazine/>



## ◆ Membership Services

### Technical Report Archives

Technical Report Archives is an archive of all the technical reports of IEICE-CS published more than one month ago. It is part of the IEICE Technical Report Online System.

### Email News

We call for papers of transactions and international conferences, as well as technical workshops from CS members by email.

## ◆ Sister Societies

Communications Society has sister-society agreements with the following six overseas societies.

- IEEE Communications Society (ComSoc)
- Informationstechnische Gesellschaft within The Verband Der Elektrotechnik Elektronik Informationstechnik (VDE/ITG)
- Korean Institute of Electromagnetic Engineering and Science (KIEES)
- The Korean Institute of Communications and Information Sciences (KICS)
- China Institute of Communications (CIC)
- IEEE Electromagnetic Compatibility Society (EMCS)

*To Probe Further and Keep Up-to-date with Communication Technologies*

# **IEICE Communications Society**

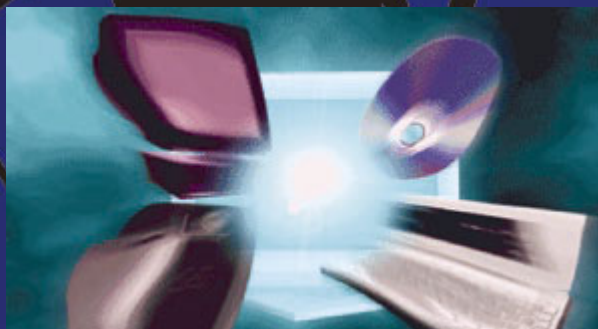

## **IEICE General Conference 2020**

**17-20 March 2020**

**Hiroshima University, Higashi Hiroshima Campus**

Every spring, each Society organizes a General Conference to provide a forum where members can present their study results and exchange views. At present, four of the Societies -- the Engineering Sciences Society, the NOLTA Society, the Communications Society, and the Electronics Society -- hold their Society Conferences as a joint event. The Communications Society Conference includes English-language sessions in addition to the Japanese-language sessions.

<https://www.ieice-taikai.jp/2020general/en/index.html>

Kikai-Shinko-Kaikan Bldg., 5-8, Shiba-Koen, 3, Minato-ku, Tokyo, 105-0011, JAPAN

Web: <http://www.ieice.org> TEL: +81-3-3433-6691 FAX: +81-3-3433-6659

IEICE Communications Society: [cs-secretariat@ieice.org](mailto:cs-secretariat@ieice.org)