

# IEICE

**Communications Society — GLOBAL NEWSLETTER —**



VOL.40 NO.3

Sept. 2016



A PUBLICATION OF THE COMMUNICATIONS SOCIETY  
The Institute of Electronics, Information and Communication Engineers

## ***IEICE Communications Society GLOBAL NEWSLETTER Vol. 40, No.3*** **Contents**

### ○ From CS Fellows

|  |   |
|--|---|
| Experiences in Research and Development of Multi-access Technologies for Mobile Communications ..... | 2 |
| Mamoru Sawahashi   |   |

### ○ From Foreign Students/Members

|  |   |
|--|---|
| Bridging Multimedia and Networks ..... | 6 |
| Zhi Liu                                |   |

### ○ IEICE-CS Activities Now

|   |   |
|---|---|
| Report on EMC Joint Workshop 2016 Taipei (EMCJ WS 2016, Taipei) ..... | 8 |
| Takehiro Morioka  |   |

|  |    |
|--|----|
| Annual Report of Technical Committee on Network Systems .....  | 10 |
| Hideki Tode, Yoshikatsu Okazaki, Atsushi Hiramatsu, Hideki Maeda, Kazuya Tsukamoto, Takuji Tachibana |    |

|   |    |
|---|----|
| Annual Report of Technical Committee on Communication Systems ..... | 13 |
| Tomohiro Taniguchi, Osamu Muta, Hidenori Nakazato, Tetsuya Yokotani |    |

|   |    |
|---|----|
| Technical Committee on Smart Radio – An Activity Report of Fiscal Year 2015 – ..... | 16 |
| Kentaro Ishizu, Koji Ohshima, Minseok Kim, Hiroyuki Shiba, Gia Khanh Tran           |    |

|  |    |
|--|----|
| Report of SmartCom 2016 – The Third International Workshop Held in Oulu, Finland – .....   | 20 |
| Kenta Umebayashi, Takeo Fujii, Shinsuke Ibi, Osamu Takyu, Gia Khanh Tran, Koji Yamamoto,<br>Keiichi Mizutani, Daisuke Anzai, Makoto Taromaru |    |

|  |    |
|--|----|
| Report on IEICE Information and Communication Technology Forum (ICTF 2016) ..... | 24 |
| Michael D. Logothetis  |    |

### ○ IEICE-CS Related Conference Reports

|  |    |
|--|----|
| Report on 8 <sup>th</sup> International Workshop on Management of the Future Internet (ManFI 2016) ..... | 27 |
| Kazuhiko Kinoshita   |    |

|   |    |
|---|----|
| Report on the 8 <sup>th</sup> International Conference on Ubiquitous and Future Networks (ICUFN) 2016 ..... | 28 |
| Yeong Min Jang, Sangheon Park   |    |

## ○ IEICE-CS Information

|  |    |
|--|----|
| IEICE-CS Related Conferences Calendar .....  | 30 |
| Special Section Calendar of IEICE Transactions on Communications .....                 | 31 |
| CFPs for Special Sections on IEICE Transactions on Communications .....                | 32 |
| IEICE Overseas Membership Page .....   | 35 |
| IEICE Overseas Membership Application Form .....                                       | 36 |
| IEICE-CS Overseas Membership with Special Annual Fees for Sister Society Members ..... | 37 |
| IEICE Overseas Membership Application Form for IEICE-CS Sister Society Members .....   | 38 |
| IEICE-CS GLOBAL NEWSLETTER Submission Guideline .....                                  | 39 |
| From Editor's Desk .....   | 41 |

## ○ Photogravure

|                                     |            |
|-------------------------------------|------------|
| IEICE Society Conference 2016 ..... | Back cover |
|-------------------------------------|------------|

**\*Color Version Available!**

*The PDF (color version) of this issue can be downloaded from IEICE-CS  
Web site below:*

[https://www.ieice.org/cs/pub/global\\_news.html](https://www.ieice.org/cs/pub/global_news.html)

# Experiences in Research and Development of Multi-access Technologies for Mobile Communications

Mamoru Sawahashi  
Tokyo City University, Japan



## 1. Introduction

In the past few decades, high capacity has become one of the most important requirements for cellular systems. This requirement can be satisfied through three approaches: extending the available frequency spectra, densifying base stations (BSs) using a small cell, and improving the spectral efficiency by introducing new radio access technologies. Fig. 1 shows the enhancements to multi-access (MA) schemes in cellular systems over the past decades. This article outlines the MA technologies for the 3<sup>rd</sup> generation (3G) Wideband Code Division Multiple Access (W-CDMA), the 4<sup>th</sup> generation (4G) Long Term Evolution (LTE), LTE-Advanced, and 5<sup>th</sup> generation (5G) cellular systems.

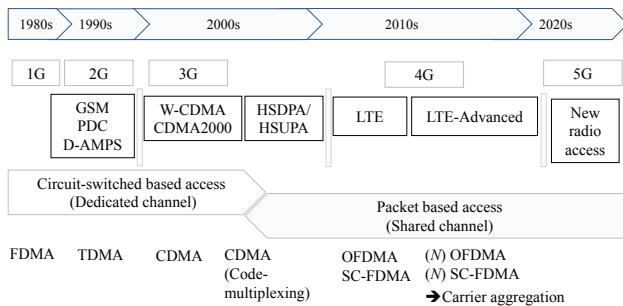

Fig. 1 Enhancements to MA schemes in cellular systems

## 2. W-CDMA and High-Speed Packet Access (HSPA) Based on CDMA

### 2.1. W-CDMA [1]

In the 1<sup>st</sup> generation analog cellular systems and 2<sup>nd</sup> generation digital cellular systems, three-cell frequency reuse was adopted to avoid co-channel interference from neighboring cells. In W-CDMA, one-cell frequency reuse is adopted to increase the system capacity of voice communication channels. One-cell frequency reuse was achieved through physical channel multiplexing in the code domain, and the MA interference from the own cell and the neighboring cells are suppressed by the processing gain. Fig. 2 shows trends in the MA schemes for the respective generation systems from the viewpoint of interference coordination (IC) among multiplexed physical channels. In the W-CDMA downlink, two-layered spreading code assignment, which is a combination of cell-specific scrambling code and user-specific orthogonal code, is adopted. By employing the user-specific Walsh-Hadamard code using the orthogonal variable spreading factor (OVSF), orthogonality among

multiplexed physical channels is achieved for the same propagation path in a multipath fading channel.

Some key radio access technologies are introduced into W-CDMA including signal-to-interference power ratio (SIR)-based transmit power control (TPC), the pilot-symbol assisted coherent Rake receiver, turbo code, and macro diversity called soft handover. These technologies achieved higher system capacities compared to the 2<sup>nd</sup> generation (2G) cellular systems using time division multiple access (TDMA). We note that different MA schemes were adopted between frequency division duplex (FDD) and time division duplex (TDD) modes, i.e., W-CDMA for FDD and Time Division (TD)-CDMA for TDD.

| Interference coordination (IC) |    | W-CDMA                 | LTE                                   | LTE-Advanced                         |
|--------------------------------|----|------------------------|---------------------------------------|--------------------------------------|
| Intra-cell                     | DL | (Partially) orthogonal | Orthogonal                            | Orthogonal                           |
|                                | UL | Non-orthogonal         | Orthogonal                            | Orthogonal                           |
| Inter-cell                     | DL | Non-orthogonal         | Fractional FR, IC in frequency domain | IC in time domain, CoMP transmission |
|                                | UL | Non-orthogonal         | Fractional FR, IC in frequency domain | CoMP reception                       |

Fig. 2 Trends in MA schemes from the viewpoint of interference coordination

## 2.2. HSDPA and HSUPA (1) HSDPA [2]

In the period when W-CDMA commercial service was launched, the amount of data traffic had been increasing remarkably due to the spread of mobile Internet. The employed resource assignment method based on dedicated channels does not provide efficient resource utilization, although it is appropriate for multiplexing low-rate physical channels carrying voice traffic with low latency. Resource assignment including the spreading code and transmit power is conducted at a radio network controller (RNC), not at a NodeB or BS for W-CDMA. Hence, in High-Speed Downlink Packet Access (HSDPA), a shared channel called the High-Speed Downlink Shared Channel (HSDSCH) is used to carry user data based on the W-CDMA radio interface. The user data is transmitted using a resource unit with the duration of 2 ms, which is referred to as the transmission time interval (TTI). Radio resources are assigned to the best user by using channel-dependent scheduling based on the reported channel quality indicator (CQI) from the set of the user equipment (UE) and based on the quality of service (QoS) requirement for the offered traffic. Adaptive rate control according to the channel condition of a UE is applied to HSDPA. The user data rate is controlled by the employed modulation scheme, coding rate of the

turbo code, and the number of multiplexed code channels with the spreading factor of 16. Hybrid automatic repeat request (ARQ) associated with soft combining is another effective technique that can reduce block errors. In HSDPA, fast hybrid ARQ based on incremental redundancy is achieved with a short round trip delay (RTD) of 6 TTIs in the medium access control (MAC) layer at a NodeB. In packet radio access using a shared channel, the increase in the peak data rate directly leads to an increase in the system capacity. The achievable peak data rate is 14.4 Mbps for HSDPA based on the 3<sup>rd</sup> Generation Partnership Project (3GPP) Release (Rel.) 5 specification assuming one-antenna transmission and 16QAM. It is enhanced to 168.8 Mbps based on Rel. 10 HSDPA by using 64QAM, 2-by-2 multiple-input multiple-output (MIMO) multiplexing, and 4 carriers. Smooth enhancement is achieved by an increase in the modulation order, the number of available antennas, and extending the transmission bandwidth.

## (2) HSUPA [2]

An enhanced dedicated channel (E-DCH) is used to carry user data in High-Speed Uplink Packet Access (HSUPA). In the uplink, wide area coverage is required with higher priority compared to the increase in the link capacity. Hence, the modulation scheme is QPSK in the Rel. 6 specification. The TTI length of 2 ms is added to that of 10 ms. TPC and soft handover are used as well as a W-CDMA dedicated channel. Hybrid ARQ with soft combining is applied. The achievable peak data rate is 5.67 Mbps with QPSK in the Rel. 6 specification and it is enhanced to 22.5 Mbps by using 16QAM and a 10-MHz bandwidth in the Rel. 10 specification.

## 3. LTE and LTE-Advanced

### 3.1. LTE [3,4]

#### (1) System requirements

Radio access networks (RANs) that have high affinity to all Internet protocol (IP) based core networks are requested to achieve efficient multiplexing of data traffic including video message and download. In LTE, only a packet based MA scheme employing a shared channel is specified along with the voice over IP (VoIP) capability in packet-switching domain. Multiple scalable transmission bandwidths with the maximum of 20 MHz are specified so that LTE is deployed for the existing frequency spectra. Low latency including a short transmission delay in a RAN such as less than 5 ms one way is required. Requirements for the peak data rate are 100 Mbps and 50 Mbps in the downlink and uplink, respectively. Higher cell throughput and cell-edge user throughput requirements are specified compared to those for Rel. 5 HSDPA and Rel. 6 HSUPA in the downlink and uplink, respectively.

#### (2) MA schemes

Since high commonality of the radio interface is requested, the same frame structure and MA schemes are specified for both FDD and TDD modes. In the downlink, orthogonal frequency division multiple access (OFDMA) is adopted because of its inherent

immunity to multipath interference due to its low symbol rate, use of a cyclic prefix, and support of different transmission bandwidth arrangements. In the uplink, single-carrier frequency division multiple access (SC-FDMA) is adopted for its prioritization of wide area coverage provisioning due to a reduction in the transmission back-off in the transmitter power amplifier. Discrete Fourier transform (DFT)-spread orthogonal frequency division multiple access (OFDMA) is adopted that generates SC-FDMA signals in the frequency domain. Fig. 3 shows the transmitter structure for OFDMA and DFT-spread OFDM. By using frequency domain processing, the same radio parameters including the subcarrier spacing, fast Fourier transform (FFT) block size, and subframe length are designed for both OFDMA and DFT-spread OFDM. The frequency domain equalizer for DFT-spread OFDM achieves a practical implementation level that provides lower computational complexity compared to the time domain equalizer. Moreover, adaptive transmission timing control is used in the uplink to achieve orthogonal multiplexing among simultaneously accessing channels.

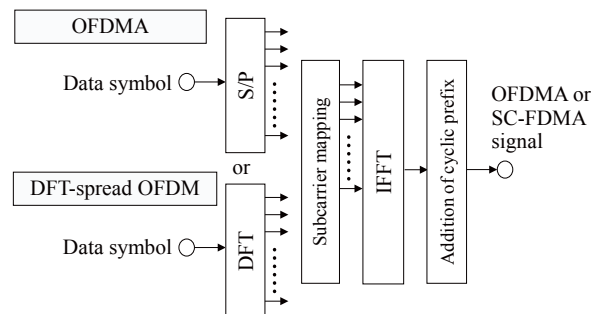

Fig. 3 Transmitter structure for OFDMA and DFT-spread OFDM

#### (3) Key techniques satisfying system requirements

The low transmission delay of 5 ms is achieved by a 1-ms subframe length that corresponds to the TTI and the RTD becomes 8TTIs. In LTE, frequency domain channel-dependent scheduling, adaptive modulation and coding (AMC), and hybrid ARQ with soft-combining are used in both links. The requirements for cell throughput, cell-edge user throughput, and frequency efficiency in the LTE downlink are achieved by the application of the intra-cell orthogonal MA scheme using OFDMA, 64QAM, frequency domain scheduling, and maximum 4-by-4 MIMO multiplexing. Similarly, these requirements in the LTE uplink are achieved by the application of DFT-spread OFDM, 16QAM, frequency-domain scheduling, and receiver diversity with the maximum of 4 antennas. The peak data rate of 100 Mbps in the downlink is achieved using a 20-MHz transmission bandwidth employing 64QAM and 2-by-2 MIMO multiplexing. Moreover, the peak data rate of 50 Mbps in the uplink is achieved through a 20-MHz bandwidth using 16QAM and 2-antenna receiver diversity.

### 3.2. LTE-Advanced [4,5]

#### (1) MA schemes

By maintaining backward compatibility with the LTE radio interface, a higher peak data rate, frequency

efficiency, cell throughput, and cell-edge user throughput are necessary compared to those for Rel. 8 LTE. Hence, the carrier aggregation (CA) concept is adopted in which the total transmission bandwidth of each link comprises contiguous or non-contiguous component carriers (CCs). The transmission bandwidth of each CC corresponds to the maximum bandwidth of the LTE radio interface or 20 MHz. In particular, CA with non-contiguous CCs enables flexible usage of frequency resources with different frequency spectra. Within a CC, the same MA schemes as those in LTE are used. In the uplink,  $N$ -times DFT-spread OFDM is used to generate a wider transmission bandwidth than 20 MHz across multiple CCs. The clustered transmission scheme is adopted in addition to the localized transmission mode to achieve a more flexible resource assignment in the frequency domain.

## (2) Key techniques satisfying system requirements

In order to satisfy the higher system requirements in LTE-Advanced, MIMO channel techniques have evolved beyond those in LTE. The single-user (SU) and multiuser (MU)-MIMO multiplexing schemes with the maximum of 8-by-8 and 4-by-4 antenna configurations are adopted in the downlink and uplink, respectively. The requirements for the peak data rate of 1 Gbps and 500 Mbps are achieved by wider transmission bandwidths up to 100 MHz and by the maximum of 8-by-8 or 4-by-4 MIMO multiplexing schemes in the downlink and uplink, respectively. The peak frequency efficiencies of 16.3 and 8.4 bits/s/Hz are achieved by 4-by-2 and 2-by-4 SU-MIMO multiplexing in the downlink and uplink, respectively. Moreover, higher system capacities compared to that for LTE are achieved mainly by MU-MIMO and SU-MIMO in the downlink and uplink, respectively. The improvement in the cell-edge user throughput is achieved mainly by coordinated multi-point (CoMP) transmission in the downlink and the application of codebook based transmit diversity in the uplink. To support the multi-antenna techniques with more than four antennas, new reference signals (RSs) are specified including a channel-state information RS (CSI-RS) and UE-specific demodulation RS (DM-RS) that suppress the increase in the RS overhead to a low level. Relaying is adopted to extend the coverage area at low cost in the Rel. 10 LTE-Advanced radio interface. Relaying is regarded as a wireless backhaul that is used to configure independent cells.

To enable efficient transmission of user traffic, control channels such as the physical downlink control channel (PDCCH) are specified. The PDCCH carries downlink control information (DCI) that includes the downlink resource assignment, uplink resource grant, modulation and coding scheme information, and/or other control information for a UE. The PDCCH is multiplexed by time division multiplexing at up to three or four OFDM symbols at the beginning of each subframe. However, the PDCCH transmits a limited number of DCI messages, which is a bottleneck for the cross-carrier scheduling among multiple CCs in CA, MU-MIMO, and CoMP. Hence, the enhanced PDCCH (EPDCCH) is specified in the Rel. 11 specifications. In

the EPDCCH, frequency division multiplexing is adopted to achieve increased control channel capacity and to support frequency domain inter-cell interference coordination (ICIC), frequency domain scheduling, and beamforming. Moreover, advanced UE receivers including interference rejection combining (IRC) and low cost machine type communications (MTC) are investigated for the Rel. 11 specifications. Full dimension (FD)-MIMO is investigated that utilizes a two-dimensional antenna array [6]. FD-MIMO forms narrow beams to achieve MU-MIMO in the azimuth and elevation domains. The related RSs are specified in the Rel. 13 specifications.

## (3) CoMP

When using soft handover in the downlink adopted for W-CDMA, multiple physical channels with different cell-specific scrambling codes are transmitted from the candidate cell sites. However, due to the mutual interference among the simultaneously transmitted channels, the macro diversity gain is small. Hence, soft handover is not supported for the HS-DSCH. In LTE, soft handover is not adopted either, due to the small macro diversity gain. Soft handover needs the increasing implementation complexity of a higher layer node such as RNC and that of a UE. The improvement in the cell-edge user throughput is one of the most important system requirements for LTE using one-cell frequency reuse as a baseline. To improve the cell-edge user throughput, the usage of power resources of multiple cell sites is the most effective method. Hence, in the Rel. 11 radio interface, CoMP transmission and reception are investigated and the related signaling is specified. CoMP transmission in the downlink is similar to soft handover in that the physical channels transmitted from multiple cell sites are added up at a UE. However, unlike in soft handover, multiple physical channels carrying the same user data are combined without suffering from mutual interference. This is because the same signals are transmitted after being multiplied by the best respective precoding vectors so that the received signal-to-noise power ratio (SNR) of the combined signal at a UE is maximized. The influence from channel estimation error is low since the estimated channel response associated with each antenna port is used only to select the best precoding vector from the limited number of codebooks.

## (4) Heterogeneous networks

As we described earlier, the system capacity has been increased by BS densification using local cells or small cells. In the conventional local cell deployment, a local-area cell site is a stand-alone system that operates independently from a macrocell. A local cell node has the same functions as those of a macrocell node such as transmission of the cell-specific RS, and system- and cell-specific control information. A UE can connect a radio link with either a macrocell or local cell. Heterogeneous networks (HetNets) have recently drawn attention in which a macrocell is overlaid onto small cells or local cells including micro and picocells. Assuming HetNets, the phantom concept or soft cell concept associated with a lean carrier is proposed in [7]

and [8], respectively. Fig. 4 shows the operational principle of the phantom or soft cell concepts. In these concepts, a small cell operates in cooperation with a macrocell. A macrocell guarantees wide area coverage mainly focusing on control signals in the control plane including system information, radio resource control (RRC) information, and low-rate user data for high-mobility users. The small cells mainly accommodate UEs that demand high-speed data services and are under low mobility conditions. The overhead of the RS and control signals is decreased for a small cell achieving a lean carrier that decreases the amount of interference imparted to the surrounding cells and operational cost.

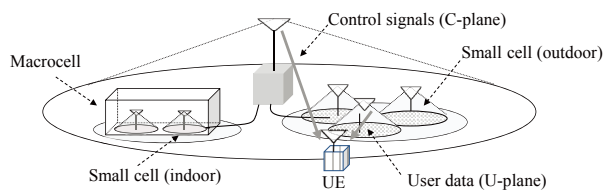

Fig. 4 Phantom cell or soft cell concept in heterogeneous networks

In [9], several typical deployment scenarios for HetNets are specified. In the scenario using the same frequency spectrum for a macrocell and outdoor small cell, the coverage area is extended compared to the cell configuration with only a macrocell. Dynamic interference coordination in the time domain using an almost-blank subframe is specified to avoid co-channel interference from a macrocell to a small cell. The scenarios employing separate frequency spectra provide more flexible deployment of small cells in an area with high traffic demand compared to those using the same frequency spectrum because they do not suffer from mutual co-channel interference.

#### 4. 5G Cellular Systems [10,11]

The study item (SI) investigation of a new radio interface for 5G cellular systems has started in the 3GPP. The SI aims at developing a single technical framework that addresses usage scenarios including enhanced mobile broadband (eMBB), massive MTC, and ultra-reliable low latency communications (URLLC). In the uplink, non-orthogonal MA schemes are proposed that do not use grant based resource assignment and tight transmission timing control to achieve a very short latency. Various types of filtered-OFDM schemes are proposed to achieve more efficient and flexible resource utilization compared to OFDMA with a rectangular pulse in LTE.

#### 5. Conclusion

In this article, we briefly presented the MA technologies for W-CDMA, HSDPA/HSUPA, LTE, LTE-Advanced, and 5G systems. Based on personal experience from research and development activities, the following points are important and noteworthy.

- In the 3GPP, the system requirements are specified first. The best radio access techniques and numerology are specified so that the system requirements are satisfied. This standardization

process leads to the development of an excellent radio interface.

- Major technical pillars are almost identical regardless of the radio access systems of the respective generation. Hence, according to the system requirements, the development of the key pillar technology is important.
- Technologies that provide the best performance considering the overhead of RSs and control signals are desirable.
- Forward compatibility or smooth enhancement of the achievable performance by extending the transmission bandwidth and/or number of antennas is a promising approach assuming the same MA schemes and frame structure.
- Backward compatibility is also an important requirement from the viewpoint of reducing the network cost.

#### 6. References

- [1] H. Holma and A. Toskala, "WCDMA for UMTS, Third Edition," John Wiley & Sons Ltd., 2004.
- [2] H. Holma and A. Toskala, "HSDPA/HSUPA for UMTS," John Wiley & Sons Ltd., 2006.
- [3] H. Holma and A. Toskala, "LTE for UMTS, evolution to LTE-Advanced," John Wiley & Sons Ltd., 2011.
- [4] H. Holma and A. Toskala, "LTE-Advanced," John Wiley & Sons Ltd., 2012.
- [5] E. Dahlman, S. Parkvall, and J. Skold, "4G LTE/LTE-Advanced for mobile broadband," Academic Press, 2011.
- [6] J. Lee, *et al.*, "LTE-Advanced in 3GPP Rel-13/14: An evolution toward 5G," *IEEE Com. Mag., Communications Standards Supplement*, pp. 36-42, March 2016.
- [7] 3GPP RWS-120010, "Requirements, candidate solutions & technology roadmap for LTE Rel-12 onward," NTT DOCOMO, June 2012.
- [8] 3GPP RWS-120003, "LTE release 12 and beyond," Ericsson, June 2012.
- [9] 3GPP TR 36.872 (V12.1.0), "Small cell enhancements for E-UTRA and E-UTRAN – Physical layer aspects," Dec. 2013.
- [10] E. Dahlman, *et al.*, "5G Wireless Access: Requirements and Realization," *IEEE Com. Mag., Communications Standards Supplement*, pp. 42-47, Dec. 2014.
- [11] T. Nakamura, *et al.*, "5G radio access: Requirements, concept and experimental trials," *IEICE Trans. on Commun.* vol. E98-B, no. 8, pp. 1397-1406, Aug. 2015.

# Bridging Multimedia and Networks

Zhi LIU  
Waseda University



## 1. Introduction

I am really honored to have this chance to share some of my experiences in Japan. I was born in China and graduated from University of Science and Technology of China (USTC) with bachelor degree in computer science and technology. Then I came to National Institute of Informatics (NII) and The Graduate University for Advanced Studies (Sokendai) for my Ph.D study, supervised by Prof. Yusheng Ji and Prof. Gene Cheung. After the graduation, I worked as a JSPS research fellow for another two months and then work in Waseda University until now with Prof. Yoshiaki Tanaka, Prof. Hiroshi Watanabe and Prof. Toshitaka Tsuda.

It is really nice to study and work in Japan, and I would like to share some of my thoughts briefly.

## 2. Ph.D Study in NII and Sokendai

NII is located near the Royal Palace and Tokyo Station, which is the core area of Japan and very beautiful. I started my Ph.D. research around April 2010, mentored by Prof. Ji and Cheung. Prof. Ji works on networks and has a network group with around 15 members. Prof. Cheung focuses mainly on image processing, he is very active in academia and has close relationships with many professors all over the world. Both professors are extinguished experts in their research fields and great life mentors. They all work extremely hard and pay great attentions to the details.

My research theme is ‘Error resilient multi-view video streaming’. The motivation of this choice is as follows: A large portion of all consumer internet traffic is video traffic. Single-view video only provides one view direction for an event at any time instance, while users may want to watch from different directions. And users are in a passive position, even in a live video service; users can only watch the pre-selected view in the video contents. Multiview video consists of multiple video sequences capturing different views of the same scene can potentially allow users to play back and switch between different views interactively. In addition, virtual intermediate views could be rendered using captured video of adjacent viewpoints via depth image based rendering (DIBR). With these features, multiview video can potentially enhance visual experience greatly over previous single-view video communication. Multiview video streaming is one fundamental technique for various application such as multi-view sports events broadcasting (such as soccer, baseball, skating), medical treatment (surgery) supported by FVV, multi-view travel guide (multi-view

version of place of interest), free viewpoint TV, etc.

How to transmit the multiview over the lossy network is an important issue, since multi-view transmission over heterogeneous lossy networks is common in many video applications. We tried to solve this problem at the video system level, and jointly consider the video encoding, transmission and frame recovery, which lead to very good results [1] [2].

Besides this topic, I also had the chance to work on other related topics such as vehicular network, heterogeneous networks [3] and information centric network [4], etc. My view is that video is super important, but video streaming strategies over different types of networks should be different and could be optimized based on the corresponding network characters. For example, routers in information centric networks can pre-cache the content, which is quite different from the traditional networks. How to optimize the video network transmission considering this is non-trivial.

I try to connect the multimedia and network, which belong to two different IEEE societies: i.e. Signal Processing Society and Communication Society. All my researches are initialed from this angle, i.e. how to stream the video over various types of networks optimally by jointly investigating the multimedia and network. From time to time, I find the network itself could be improved, then I work on the network itself and optimize it. E.g. when I observe the interference management in literature is capacity-centric, but users care whether their data rate requests could be satisfied or not more. Then I proposed a new management method from the standing points of users [3].

In NII, besides attending the conferences, I also had the chances to visit Prof. Sherman Shen in University of Waterloo, Canada, Prof. Pascal Frossard and Dr. Jacob Chakareski in EPFL, Switzerland, Prof. Jie Liang and Ivan Bajic in SFU, Canada et. al. They all boarder my vision, helped me greatly during my visit and later on. These experiences are quite important for me.

## 3. Work in Waseda University

I then work in Waseda University with Prof. Tanaka, Prof. Watanabe and Prof. Tsuda, mainly in the area of wireless networks.

Prof. Tanaka is a leading expert in network system, information and communication management, communication quality and pricing, and has made extraordinary contributions in these topics. Students in the lab are mainly working on the network economic and wireless networks especially the ad hoc networks.



Prof. Watanabe focuses mainly on image processing especially recognition using deep learning. Prof. Tsuda used to work in Fujitsu lab and now is working in Waseda University on various big projects.

The atmosphere and environment here is outstanding as well. It is a very nice place to sit down and work at. Regular group meetings and joint seminar with other universities are held. Lively discussions are made and the presenters can always receive many useful feedbacks. Besides the theoretical researches, I have the chance to work on some big project with other industry companies and research institutes. The main task is to provide the testbed which makes the research more real. The close relationship with industry companies improves my vision as well, and I learn a lot from this process in various aspects.

#### 4. Life in Japan

The faculty and students in both NII and Waseda University are very smart and work very hard, they do things very quickly and they motivate me to move forward every day.



Fig. 1 The fireworks party in Tokyo Bay

But this is not my whole life, besides the research, Japan is a good place to enjoy. My impression to the Japan from this aspect is 1) it is a very clean, safe country and in good order. People here are well disciplined. It is hard to see people obey the rules. The cities are very clean, and people cherish the environment greatly. Also it is quite safe comparing most of the cities in the world. 2) It is a very beautiful country. There are many good places to explore. We can always find some merits in every place. 3) People pay great attentions to the details and try to make everything the best. And most of the researches are product-oriented, people here try to their best to polish their work. The university research is sometime product oriented as well, with the focus on the real system instead of paper only.

#### 5. Conclusion

Overall, I work on the video and networks, and try to optimize the video distribution over various emerging networks such as the information centric network, vehicular network, heterogeneous network, etc. Meanwhile, I also optimize the wireless network itself. Regarding Japan, it is very easy and convenient to live in. And Japan is a nice country to study and work at. People can concentrate what they are interested in.



Fig. 2 The symbol of Japan: Kinkaku-ji

#### 6. Acknowledgements

I would like to take this opportunity to express my sincerely thanks to all the people who help me during the journey, especially my advisors in Waseda University: Prof. Yoshiaki Tanaka, Prof. Hiroshi Watanabe and Prof. Toshitaka Tsuda, my Ph.D advisors: Prof. Yusheng Ji and Prof. Gene Cheung, my colleagues and lab mates in both Waseda University and NII, and my colleagues and friends abroad. They all support me strongly and motivate me. Thank you.

#### 7. References

- [1] Zhi Liu, Gene Cheung, Jacob Chakareski and Yusheng Ji, "Multiple Description Coding & Recovery of Free Viewpoint Video for Wireless Network Streaming," IEEE Journal of Selected Topics in Signal Processing, May 2014.
- [2] Zhi Liu, Gene Cheung and Yusheng Ji, "Optimizing Distributed Source Coding for Interactive Multiview Video Streaming over Lossy Networks," IEEE Transactions on Circuits and Systems for Video Technology, vol. 23, no. 10, pp. 1781-1794, Oct. 2013.
- [3] Zhi Liu and Yusheng Ji, "Intercell Interference Coordination under Data Rate Requirement Constraint in LTE-Advanced Heterogeneous Networks," 2014 IEEE VTC spring, May 2014.
- [4] Zhi Liu, Mianxiong Dong, Bo Gu, Cheng Zhang, Yusheng Ji and Yoshiaki Tanaka, "Fast-start Video Delivery in Future Internet Architectures with Intra-domain Caching," ACM/Springer Mobile Networks and Applications, February 2016.

# Report on EMC Joint Workshop 2016 Taipei (EMCJ WS 2016, Taipei)

Takehiro Morioka  
Secretary, Technical Committee of Electromagnetic Compatibility



## 1. Introduction

The Technical Committee on Electromagnetic Compatibility (TC-EMCJ) has held an annual workshop outside Japan as one of the international activities since 2015. The 2<sup>nd</sup> EMC Joint Workshop was held from June 2 to 3 at the National Taiwan University (NTU), Taipei this year. The workshop was collocated by Technical Meeting on Electromagnetic Compatibility of IEEJ (IEE-EMC) and Technical Meeting on Magnetics of IEEJ (IEE-MAG), and hosted and supported by the Department of Electrical Engineering, NTU.

## 2. Technical Sessions

The workshop started following the opening addresses by Professor Hideaki Sone, Committee chair of TC-EMCJ and Professor Tzong-Lin Wu, the local host of EMCJ WS 2016, Taipei.

The workshop had 16 regular and 2 invited talks. In addition, we also had a poster session with 11 papers following a short oral presentation (Table 1). The venue, Barry Lam Hall at NTU campus (Fig. 2) was filled with attendees and we had fruitful discussions on the presentation topics throughout the two-day workshop. The titles of the presentation are listed below:

*June 2*

Regular Session 1

- 1) Compact Spiral Patch EBG Structure with a Shunt Capacitor for Broadband SSN Suppression
- 2) A TSV-Based Common-Mode Suppressing Filter in 3-D ICs
- 3) Shielding Effectiveness of Meltblown Non-Woven Fabric Type Non-Magnetic Noise Suppressor
- 4) Study on Conductive-Strip Grid-Pattern Characteristics and their Application as Absorber Material
- 5) An absorptive balanced bandpass filter based on slot couple lines
- 6) Elimination of Radiation on Cable-Attached High-Speed Interfaces
- 7) Identifying Dominant Factor of EMI of Asymmetrical Differentia-Paired Lines with Different Termination Condition
- 8) Calculating EMS and EMI for Volumes of Microstrip Lines by Analytical Formula
- 9) Efficiency Enhancement of Near Field Coupled Antenna Pair Using Reflector for Wireless Power Transmission



Fig. 1 Prof. Sone presenting a gift to Prof. Wu



Fig. 2 Workshop site (Barry Lam Hall) at NTU

Poster Session

- 1) Study on Side-Channel Analysis Based on Asynchronous Measurement
- 2) Study on Fault Sensitivity Analysis of Cryptographic Device under IEMI
- 3) Investigation of Relationship between Signal-to-Noise Ratio of EM Information Leakage and Side-Channel Attacking Cost.
- 4) An on-chip dual-mode rat-race coupler for closely-spaced two-element antenna arrays
- 5) Validation of Optimization Method of On-board RL Snubber According to Q Factor
- 6) Characterization and Modeling of CMOS On-Chip Symmetric Coupled Transmission Lines
- 7) A Broadband Filter Design for Common-Mode Noise Rejection with Multilayer Mushroom Structure in Differential Transmission Line
- 8) Design and Application of Radio Frequency Current Probe for IC-EMI Measurement
- 9) Near-field to Far-field Transformation using Non-contacting Near-field Measurement with Kirchhoff Surface Integral Representation in the Frequency Domain

- 10) A study on the relation between surface roughness of spherical electrode and amplitude of electromagnetic radiation due to ESD
- 11) Measurement of current distribution on vertical coupling plane in the ESD immunity test

#### Invited Talk 1

- 1) Modeling and Measuring Vertical Interconnects with Impedance Control Over a Wide Frequency Range

#### June 3

##### Regular Session 2

- 10) An experimental investigation on conducted emission characteristics of SiC MOSFET in a DC-DC boost converter
- 11) Study of Frequency Offset Behavior for Artificial Magnetic Structure in Compact Mobile Device
- 12) Metal Meshed Antenna on the Novel Ultra-Slim Flexible Glass Substrate
- 13) A study on system characterization of an optical E-field probe
- 14) Experimental Calibration of Radiation Pattern Distortion from Phased Array Antennas due to Implementation Errors
- 15) Design Considerations of Multi-Column and Multi-Band LTE Base Station Antennas to Reduce the High-Order Harmonic Signals
- 16) A Prediction Method of the Substrate Noise and The SI Issues in 3-D ICs Based on Modified 3-D TLM Method

#### Invited Talk 2

- 2) EM Information Security of Tablet PCs in Public Space

Table 1 Number of technical papers

|        | Oral | Poster | Total |
|--------|------|--------|-------|
| Japan  | 6    | 6      | 12    |
| Taiwan | 12   | 5      | 17    |
| Total  | 18   | 11     | 29    |

### 3. Attendees

As shown in Table 2, the number of attendees from both countries, Japan and Taiwan in the technical sessions of the workshop is summarized. The total number of attendees exceeded 120 for the two-day workshop. Taiwan attendees were professors and graduate/under-graduate students of NTU, Yuan Ze University and other universities. Some were from local companies and a government organization, as well. Japanese attendees were professors, graduate/under-graduate students, researchers, and engineers of universities, national laboratories, and companies (Fig. 3).

Table 2 Number of attendees

|        | June 2 | June 3 |
|--------|--------|--------|
| Japan  | 22     | 22     |
| Taiwan | 44     | 35     |
| Total  | 66     | 57     |



Fig. 3 Workshop attendees

### 4. International Exchange

A technical visit to the EMC laboratories of NTU was arranged in the late afternoon of the 2<sup>nd</sup> day of the workshop. Students explained the outline of the measurements carried out in their laboratories and the outcomes from the research works. In addition, NTU had a university tour guided by the Student Ambassadors. They explained the university history and the latest IT services introduced in the library. The understanding of the latest challenges by NTU has been deepened through these tours. In the evening of June 2, we enjoyed a Taiwanese dinner at Howard Civil Service International House located in the vicinity of the university. Attendees from Japan and Taiwan were on the same table and tightened their friendship exchanging the technical and general experiences.



Fig. 4 Technical visit to EM wave group laboratory, NTU

### 5. Conclusion

The second international EMC joint workshop, EMCJ WS 2016, Taipei was held for two days in Taipei, Taiwan. The EMCJ WS had more than 120 total attendees and was successful. TC-EMCJ would like to express great appreciation for the contribution of all speakers and attendees at the WS. We also would like to note that the successful WS could not be realized without the time and effort made by Professor Wu and his staff.

The next annual international EMC joint workshop is planned to be held in an Asian country.

### 6. Reference

- [1] <http://www.ieice.org/cs/emcj/jpn/regular/emcj-ws.html>

# Annual Report of Technical Committee on Network Systems

Hideki TODE<sup>†</sup>, Osaka Prefecture University

Yoshikatsu OKAZAKI<sup>††</sup>, NTT Corp.

Atsushi HIRAMATSU<sup>†††</sup>, NTT-AT Corp.

Hideki MAEDA<sup>††††</sup>, NTT Corp.

Kazuya TSUKAMOTO<sup>††††</sup>, Kyushu Institute of Technology

Takuji TACHIBANA<sup>†††††</sup>, University of Fukui



<sup>†</sup>Chair, <sup>††</sup>Vice Chair, <sup>†††</sup>Former Chair, <sup>††††</sup>Secretary, <sup>†††††</sup>Former Secretary

## 1. Introduction

This report covers the annual activities of the IEICE Technical Committee on Network Systems (NS). It describes activities at the monthly technical meetings, recent research topics of the committee, and the research awards for 2015.

## 2. Technical Meetings

The schedule from April 2015 to March 2016 consists of 10 technical meetings and one workshop (as shown in Table 1). Several meetings are co-located with the ICN (Information-Centric Networking), OCS (Optical Communication Systems), PN (Photonic Network), RCC (Reliable Communication and Control), ASN (Ambient intelligence and Sensor Networks), RCS (Radio Communication Systems), SR (Smart Radio), CS (Communication Systems), IN (Information Networks), NV (Network virtualization), ICM (Information and Communication Management), or CQ (Communication Quality) committees.

Recently presented papers mainly focus on technologies that support new generation network,

SDN, network virtualization, NFV, cloud computing, green ICT, ad-hoc networks, ICN/CCN, M2M, IoT, traffic control / measurement, quality of service (QoS), and security issues. At each technical meeting, we host lectures by invited speakers who are experts in their research fields. During this fiscal year, we have had invited lectures on network operation, network design, network architecture, ICN, NFV, 5G, wireless multi-hop network, and other topics. In fiscal 2015, we had 182 presentations from academia and 76 from industry.

Since June 2003, we have fostered the work of young researchers who have presented papers at technical meetings by inviting them to give a follow-up talk some months later. We call these the “encouragement talk.” We invited 11 young researchers to give such talks in the past year. We will continue this activity.

Moreover, the 1<sup>st</sup> night session was held to provide an opportunity for an exchange of views on a given topic in January 2016. In this year, issues on the network virtualization technology were discussed among all the participants enthusiastically.

Table 1: Technical meeting schedule for fiscal 2015.

| Date           | Location                              | Theme   | Co-location with  |
|----------------|---------------------------------------|---|-------------------|
| April 16–17    | Hida-jibasan (Gifu)                   | Traffic, Network evaluation, Performance, Resource Management/Control, Traffic Engineering, Reliability, Resiliency |                   |
| May 21–22      | The University of Tokyo (Tokyo)       | Advanced Protocol and Network Control, Network System Architecture  | ICN               |
| June 18–19     | Fukui-shi-chiiki-kouryu plaza (Fukui) | Core/metro system, Photonic network system, Optical network design, Traffic engineering, Signaling, GMPLS, etc      | OCS, PN           |
| July 29–31     | JA Naganoken Bldg. (Nagano)           | Wireless Distributed Network, M2M: Machine-to-Machine, D2D: Device-to-Device, etc.                                  | RCC, ASN, RCS, SR |
| September 3–4  | Iwate-ken Kokaido (Iwate)             | Post IP networking, Next Generation Network, Contingency Plan/BCP, Network configuration, etc.                      | IN, CS, NV        |
| October 15–16  | Akita University (Akita)              | Network Architecture (Overlay, P2P, Ubiquitous Network, Active Network, NGN, New Generation Network), Grid, etc.    |                   |
| November 26–27 | Niigata University (Niigata)          | Network Quality, Network Measurement and Management, Network Virtualization, Network Service, General               | CQ, ICM, NV       |
| December 17–18 | Matsuyama Community Center (Ehime)    | Multi-hop/Relay/Collaboration, Sensor/Mesh, Mobile Ad-hoc Network, D2D/M2M, Wireless network coding, etc.           | RCS               |
| January 21–22  | Hakata Bus Terminal (Fukuoka)         | Network Software, Network Application, SOA/SDP, NGN/IMS/API, Distributed Control/Dynamic Routing, Grid              |                   |
| March 3–4      | Phoenix Seagaia Resort (Miyazaki)     | General, IN/NS workshop (March 3)   | IN                |

### 3. Research Awards 2015

The Technical Committee selected recipients of the Network System Research Award from among 221 regular papers that had been presented at monthly technical meetings from January to December 2015. The award is given to the authors of the three or four best papers of each year. The 2015 recipients attended the award ceremony at the IN/NS Workshop (Fig. 1) held in Miyazaki in March 2016. The abstracts of the three papers that won awards in 2015 are as follows.

**Masaru Dobashi, Koyo Yoshida, Kazumi Takeuchi, Yoshinobu Masatani, Ryohei Suzuki, Norihiro Kawasaki, Goro Kunito, and Satoshi Tanaka: “Design and Evaluation of the Distributed Streaming System for Low Latency Applications” [1]**

Smart phones have become more and more popular and wearable devices are getting to be always used more widely. These devices have some sensors for measurement of physical quantity such as temperature, humidity, illumination, location information and so on, and can communicate via mobile network. In near future, to establish a variety of smart city services, the ability to analyze and visualize massive sensor data from these devices in near real-time will be important. This kind of systems consists of statistical computing, data storing and visualization for streaming data.

Because of the size of data, it is sometimes difficult to process the whole of data in one machine, so that a key is the distributed computing technology, such as Storm. Storm is an open source software to realize large data processing platforms and is developed actively by the development community members. Storm provides us the high availability with a low maintenance cost and the reasonable scalability about the performance.

This paper describes that design and evaluation of the distributed streaming system for the low latency application with Storm. We have designed and implemented the application system to statistically compute received massive sensor data and visualize calculated metrics in every several minutes.

This system consists of Storm, Kafka and HBase. On the presupposition that all Japanese mobile communication terminals became the smartphone which has sensors and a half of these terminals participated in this application, we evaluated our system with the realistic size of data which we artificially generated. We confirm that our system has an enough feasibility of processing and visualizing massive data in low latency.

**Natsuki Kai, Hiroshi Yoshida, Koichi Nihei, Koza Satoda, and Dai Kanetomo: “A Novel Rate Switching Method for Live Video Streaming via Mobile Network” [2]**

On live video streaming via mobile networks, playout stall is a measure problem. There are two main reasons why playout stall occurs. One is TCP

throughput fluctuation because of radio interference and other users’ traffic. The other is small playout buffer on player side because live video streaming requires low latency.

To solve the playout stall problem, adaptive rate control techniques are helpful. The adaptive rate control adjusts the video bitrate in accordance with the TCP throughput fluctuation by receiving the feedback information from the player. However, feedback delay degrades the responsibility of the rate control.

This paper proposes a novel rate control method that shortens the feedback delay by using plural codecs and detection of throughput degradation. We evaluate our proposed method with a live streaming for 600 seconds in a network condition emulating TCP throughput fluctuation on a mobile network. Playout stall occurred 59 times and lasted 46 seconds in total with the conventional method, while playout stall did not occur with the proposed method. The proposed method is able to improve Quality of Experience (QoE) defined by ITU-T P.1201 to 4.20 from 2.88 of conventional method.

**Takamitsu Iwai and Akihiro Nakao: “Identification of Mobile Applications via In-Network Machine Learning Using N-gram for Application-Specific Traffic Control” [3]**

Identifying the application transmitting a given flow of network traffic is beneficial for network management, especially for achieving application specific QoS, enabling malware detection, and executing network functions such as content caching only for a particular application. Although typical methods for application identification include port scanning and pattern recognition using application signature, they suffer from various problems, e.g., for the former, ephemeral port usage and dynamic port allocation hinder accurate application identification, and for the latter, it is costly to collect application signatures, especially from encrypted traffic. The existing researches for application identification using machine learning have shortcomings such as a limited scope of identifiable applications, inability to deal with real-time traffic, and few efforts have been put to fine-grained application identification, e.g., at the level of application identifiers such as YouTube and Chrome.

We have proposed a real-time identification method using reliable and on-line training data collection performed by adding the application identifier at the end of the SYN packet. Our existing method avoids the reference of payload, thus is robust against the encryption of packet payload and free from privacy violation. Moreover, this enables to classify newly emerging applications and generate accurate training data in real-time because the modified smartphones send the training data.

Our existing method identifies 80% mobile applications accurately without Deep Packet Inspection (DPI). In this paper, we propose a new method that improves inference accuracy using DPI even applicable

to encrypted traffic. We use N-gram features for the first 5 packets (at maximum) of packet payloads and classify the packets according to their destination port number before application identification. We evaluate our proposed method in the real MVNO traffic and show it identifies at best 92% applications accurately using 2-gram features of packet payloads. We also improve the inference accuracy from 82% without DPI to 90% with DPI when learning period is limited to 5 days.

#### 4. Future Plans

The Technical Committee will have also 10 technical meetings in this fiscal year. In addition, it will organize open Symposia in the IEICE Conferences, one of which will be on “Advanced Technologies in Communication, Networking, and its Innovative Application for Future Information Network Society” at the IEICE General Conference in March 2017.

(For more information, please see our home page.

URL: <http://www.ieice.org/cs/ns/index.html>)



Fig. 1 Research award recipients with former chair Dr. Hiramatsu

#### 5. Reference

- [1] Masaru Dobashi, Koyo Yoshida, Kazumi Takeuchi, Yoshinobu Masatani, Ryohei Suzuki, Norihiro Kawasaki, Goro Kunito, and Satoshi Tanaka, “Design and Evaluation of the Distributed Streaming System for Low Latency Applications,” *IEICE Tech. Rep.*, NS2015-27, May 2015.
- [2] Natsuki Kai, Hiroshi Yoshida, Koichi Nihei, Kozo Satoda, and Dai Kanetomo, “A Novel Rate Switching Method for Live Video Streaming via Mobile Network,” *IEICE Tech. Rep.*, NS2015-77, September 2015.
- [3] Takamitsu Iwai and Akihiro Nakao, “Identification of Mobile Applications via In-Network Machine Learning Using N-gram for Application-Specific Traffic Control,” *IEICE Tech. Rep.*, NS2015-78, September 2015.

# Annual Report of Technical Committee on Communication Systems

Tomohiro Taniguchi†, NTT; Osamu Muta†, Kyushu Univ.; Hidenori Nakazato\*\*, Waseda Univ.; Tetsuya Yokotani\*, Kanazawa Inst. of Tech.

\*Chair, \*\*Vice-Chair, †Secretary, CS Technical Committee

Web page: <http://www.ieice.org/cs/cs/>



## 1. Introduction

Technical Committee on Communication Systems (CS) actively organized seven technical conferences and one special workshop at various cities in Japan, in FY2015. In this report, we describe our activities which include seven technical conferences, Communication Systems Workshop (CSWS), special and general sessions on IEICE Society Conference 2015 and IEICE General Conference 2016, and CS Technical Committee's Prizes. Visit our web site (<http://www.ieice.org/cs/cs/>) to obtain the up-to-date information. Our topics of interest include (but are not limited to) the followings:

- Transport technology
- Modulation, coding and signal processing
- Network architecture
- Wireless network and application
- Network service and application

We are welcome to make your presentations to our conferences.

## 2. Summary of CS Technical Committee in FY2015

In Table 1, we summarize the activities of CS Technical Committee in FY2013, FY2014 and FY2015.

The number of presented papers on technical conferences was around 100 each year in three years. The total number of presented papers on IEICE Society and General Conferences is more than 120 in FY2015. Special sessions on those conferences were very well attended because there were latest technical topics and its trends. The number of participants of CS workshop was around 40 in average.

We had many interesting special invited talks by outstanding speakers in each conference. One of the most impressive talks was presented by Prof. Fumiyuki Adachi of Tohoku University in CS technical conference on 2<sup>nd</sup> July 2015 in Kumejima Island (Fig. 1). He presented overview of the mobile wireless evolution of the last 30 years and discussion about the technical issues toward the 5G networks. His talk provided us future of mobile technologies based on the virtual macro-cell network employing distributed small base stations. Another talk, impressively embedded in our memory, was presented by Prof. Yoshiki Ninomiya of Nagoya University in CS workshop on 11th November 2015 Sounkyo, Hokkaido (Fig. 2). He explained information processing technologies for automated driving and discussed the possibility of application of communication technologies.

Through the FY2015, we had many valuable special invited talks. To refer them, please visit our archive web page (<http://www.ieice.org/cs/cs/special-e.html>).

Table 1 Summary of CS Technical Committee activities

|        | Number of presented papers |   | Special session on<br>IEICE Society Conference<br>(Number of participants)   | Special session on<br>IEICE General<br>Conference<br>(Number of participants) | Number of<br>participants<br>of CSWS |
|--------|----------------------------|---|--|---|--------------------------------------|
|        | Technical<br>Conferences   | IEICE<br>Society/General<br>Conferences |  |   |                                      |
| FY2013 | 110                        | 61/76 (137)                             | Low power and energy<br>efficient technologies for<br>wired and wireless networks<br>(44)  | How to teach and learn ICT<br>(30)  | 47                                   |
| FY2014 | 110                        | 52/70 (122)                             | Issues on convergence of<br>mobile and optical-access<br>networks (74)   | Application of ICT to traffic<br>field (49)                                   | 47                                   |
| FY2015 | 89                         | 45/77 (122)                             | -Mobile Optical Networks<br>for Next Generation Mobile<br>Communications System<br>(5G) (61)<br>-Recent progress of Internet<br>of Things (IoT) and its<br>application to cyber<br>physical (37) | Simulation technology in<br>information and<br>communication fields (31)      | 35                                   |



Fig. 1 Prof. Fumiyuki Adachi giving a special invited talk at CS technical conference in Kumejima Is. on July 2015



Fig. 2 Prof. Yoshiki Ninomiya giving an invited talk at CS workshop in Hokkaido on November 2015

### 3. Activities of CS Technical Committee in FY2016

#### 3.1 Technical Conferences

We have already held July’s conference on 7<sup>th</sup> – 8<sup>th</sup> July 2016, in Miyakojima Island, successively, with two special invited speakers on ICT, 18 invited and general session speakers, and 28 participants. First special invited speaker, Prof. Toshinori Tsuboi of Tokyo University of Technology presented overview of the historical development of transmission technology especially focusing on the transport network which was established at the SDH standardization. Second special invited speaker, Prof. Masayuki Tanimoto of Nagoya Industrial Science Research Institute showed a new framework for FTV (Free-viewpoint TV) which is an ultimate 3DTV with infinite number of views.

We are planning to have seven conferences in this year, which are shown in Table 2. We appreciate your entry to them. You can obtain detailed information at our web site (<http://www.ieice.org/cs/cs/>).

#### 3.2 Special Sessions on IEICE Society and General Conferences

CS Technical Committee will organize a tutorial session of “Cooperation of edge computing and access network for IoT” on 21<sup>st</sup> September 2016, in the IEICE Society Conference 2016 (September 20<sup>th</sup>–23<sup>rd</sup>, 2016, Hokkaido Univ., Sapporo). Outstanding six speakers will be invited.

For the IEICE General Conference 2017 (March 22<sup>nd</sup>–25<sup>th</sup>, 2017, Meijo Univ., Nagoya), we are now planning to have a highly motivated tutorial session.

Table 2 Technical Conferences schedule, May 2016 – April 2017

| Date          | Venue   | Joint committee       | Topics   |
|---------------|---|-----------------------|--|
| July 7 – 8    | Hirara-kou terminal bldg. (Miyakojima Island)   | –                     | Next Generation Networks, Access Network, Broadband Access System, Power-Line Communications, Wireless Communication Systems, Coding System, etc.  |
| Sept. 29 – 30 | Tohoku Univ.                                    | NS, IN, NV            | Post IP networking, Next Generation Network (NGN)/New Generation Network (NWGN), Contingency Plan/BCP, Network Coding/Network Algorithms, Session Management (SIP/IMS), Internetworking/Standardization, Network configuration, etc.                                 |
| Nov. 10 – 11  | TBA (Hokkaido)                                  | CSWS                  | Broadband Access Systems, Home Networks, Network Services, Applications for Communications, etc.   |
| Dec. 8 – 9    | Ishikawa Industrial Promotion Center (Kanazawa) | IPSJ-AVM, IE, ITE-BCT | Image Coding, Streaming, etc.  |
| Jan. 19 – 20  | Kyushu Sangyo Univ.                             | OCS                   | Network Core/Metro Systems, Submarine Transmission Systems, Optical Access Systems/Next Generation PON, Ethernet, Optical Transport Network (OTN), Transmission Monitoring and Supervisory Control, Optical Transmission System Design/Tools, Mobile Optical Network |
| Feb. 23 – 24  | Hikone kinrou fukushi kaikan (Hikone)           | CAS                   | Network Processor, Signal Processing Circuits for Communication, Wireless LAN/PAN, etc.  |
| Apr. (TBA)    | TBA   | CQ, NV                | SDN (Software-Defined Networking), NFV (Network Functions Virtualization), Network Virtualization, Cloud, Service Quality, Contents Delivery, etc.   |



### 3.3 CS Workshop

CS Workshop 2016 will be held in Hokkaido, on 9<sup>th</sup>–11<sup>th</sup> November 2016. Assoc. prof. Tetsuo Tsujioka, General Chair of the workshop, has invited several outstanding researchers for providing talks about various categories. Please visit to the web site (<http://www.ieice.org/cs/cs/jpn/cs/ws/index.html>) for more information.

### 3.4 CS Prizes

CS Technical Committee provides prizes to authors or speakers who made good presentations and excellent papers every year. The detailed information on the committee's prizes is described in Table 3.

Table 3 CS committee's prizes

|                   |  |
|-------------------|--|
| Chairman's prize  | Summary: The aim of the chairman's prize to the superior papers is activating investigations on communication systems engineering.   |
|                   | Candidates: The paper must be submitted to the IEICE committee on communication systems.   |
| Encouraging prize | Summary: The aim of the encouraging prize to the excellent speakers is encouraging young researchers who are engaged in communication systems engineering.   |
|                   | Candidates: The speaker must be less than 33 years of age at the time of the workshop in which the speaker made a presentation. His/her paper must be submitted to the IEICE committee on communication systems. |

The winners of the chairman's prize in 2015 are the authors of three papers [1]-[3]. The speakers of the papers are Prof. Saeko Oshiba, Mr. Takashi Hirose and Mr. Tomoya Kageyama.

The winners of the encouraging prize in 2015 are the speakers of four papers [4]-[6], Ms. Ayako Inoue, Mr. Takumi Matsunaga, and Mr. Naoki Agata.

Four invited talks by the speakers of CS2015-73, CS2015-97, CS2015-22, and CS2015-75 were conducted and the prize ceremony 2015 was held at the banquet in the technical conference in Miyakojima Island on July 7<sup>th</sup>, 2016. The ceremonial photograph is illustrated in Fig. 3.

### 4. Conclusion

This report has summarized activities of Technical Committee on Communication Systems. Any comments and feedbacks are appreciated to improve our activities. We welcome your submission to our conferences (<http://www.ieice.org/cs/cs/>).



Fig. 3 The prize ceremony 2016 in Miyakjima Island on July 7<sup>th</sup>, 2016. From left, Ms. Inoue, Assoc. Prof. Muta, Mr. Kageyama, Prof. Yokotani (CS Chair), Mr. Yoshida and Mr. Agata

### 5. References

- [1] Saeko Oshiba and Natsuno Kado, "Visible Light Multiplex Communication using RGB Multi-Color LED," IEICE Tech. Rep., CS2015-45, pp. 1 – 4, Nov. 2015.
- [2] Keisuke Nishi, Shigeo Otsu, Seiji Yoshida and Takashi Hirose, "Improvement of the time synchronization precision by the network-assisted GPS time synchronization systems," IEICE Tech. Rep., CS2015-73, pp. 1 – 6, Jan. 2016.
- [3] Tomoya Kageyama, Osamu Muta and Haris Gacanin, "A Study on Selection of Peak Detection Threshold of Peak Cancellation for OFDM Signals," IEICE Tech. Rep., CS2015-97, pp. 69 – 72, Feb. 2016.
- [4] Ayako Inoue, Hiroshi Bessho, Yoshifumi Hotta and Ryusuke Kawate, "A Prototype Evaluation of Low Latency Ethernet Switch with Frame Preemption," IEICE Tech. Rep., CS2015-22, pp. 69 – 74, July 2015.
- [5] Takumi Matsunaga, Kentaroh Toyoda and Iwao Sasase, "Privacy-preserving Biometric Authentication with Homomorphic Encryption by Comparing Partial Bio-information," IEICE Tech. Rep., CS2015-28, pp. 103 – 108, July 2015.
- [6] Naoki Agata, Naoya Nishi, Akira Agata, Shinobu Nanba and Kosuke Nishimura, "A Study on Optimal Design for Mobile Fronthaul Network," IEICE Tech. Rep., CS2015-75, pp. 13 – 17, Jan. 2016.

# Technical Committee on Smart Radio – An Activity Report of Fiscal Year 2015 –

Kentaro Ishizu, Koji Ohshima, Minseok Kim,  
Hiroyuki Shiba, and Gia Khanh Tran  
IEICE Technical Committee on Smart Radio



## 1. Introduction

The Technical Committee on “Smart Radio” (TCSR) has taken over its previous name “Software Radio” in May 2014. The fiscal year 2015 (FY2015) is the second year for the TCSR as the current name. Prof. Fujii took up the TCSR chair’s position in the beginning of FY2015 succeeding Prof. Sakaguchi. This reports overviews activities of the TCSR in FY2015.



Fig. 1 Greetings from the former TCSR chair Prof. Sakaguchi (left) and the current chair Prof. Fujii (right) at the banquet of technical conference in Akashi in May 2015

## 2. Technical Conferences in Fiscal Year 2015

### 2.1 The 1st Conference in May 2015

- Date: May 28<sup>th</sup> – 29<sup>th</sup>, 2015
- Venue: Akashi Industrial Communication Center
- Topics: Cognitive Radio, Spectrum Utilization, Software Radio, etc.
- Number of papers: 15
- Number of participants: 64

#### Invited Talk

Below three invited talks were given.

- Prof. Narieda (Akashi College), “Computationally Efficient Spectrum Sensing Based on Cyclostationarity Detection Using Multiple Receive Antennas”
- Prof. Hasegawa, “Studies on cooperation of transport-layer protocols and power-saving mechanisms in wireless network devices”
- Prof. Yamamoto, “ENTERPRICE M2M Network Consisting of Enourmous Number of Terminals”

### General Session

In the general sessions, twelve papers were presented and lively discussions were held. These sessions included following technical fields:

- Spectrum Sensing
- Prototyping of TV White Space Communication Systems
- Estimation of Inter-channel Interference



Fig. 2 Invited talks (Prof. Narieda, Prof. Hasegawa, and Prof. Yamamoto from left to right)

### 2.2 The 2nd Conference in July 2015

- Date: July 29<sup>th</sup> – 31<sup>st</sup>, 2015
- Venue: JA Nagano Bld., Nagano City
- Topics: Wireless Distributed Network (WDN), M2M
- Joint TCs: ASN, RCS, NS, RCC
- Number of papers: 30  
(16 posters, 5 invited papers, 9 regular papers)
- Number of participants: 295

#### Poster Session (Wireless Distributed Networks)

This WDN poster session has been jointly coordinated by a couple of TCs in July conference in every year. In this year, 16 posters were presented (Fig. 3), of which topics are as follows:

- WLAN MAC control techniques (2 posters)
- Reliable control techniques in wireless sensor networks (4 posters)
- Transmission techniques related to MIMO, NOMA, etc. (4 posters)
- OFDM techniques (4 posters)
- Dynamic spectrum access (1 poster)
- Distributed channel sounder (1 poster)



Fig. 3 Poster session on wireless distributed networks

### Invited Talks (Technical Trend of 5G Cellular Networks and Elementary Technologies)

This session was co-organized by TCs of ASN, RCS, NS and RCC on the technical trends of 5G cellular networks and the elementary technologies from the various aspects where five distinguished researchers were invited as follows:

- Research and Development of Small Cell Base Station for 5G Network (Dr. Naoto Ishii, NEC)
- Research trends in cross-layer design of communication and control layers for reliable remote control systems (Prof. Kentaro Kobayashi, Nagoya Univ.)
- oneM2M Standards Activities -- Publication of Technical Specifications (Release 1) and Next Release – (Dr. Norikazu Yamasaki, KDDI)
- "Elastic-Core" Architecture and Network Slicing Technologies, Enabling Future Mobile Core Network for 5G and Beyond (Dr. Shigeru Iwashina, NTT docomo)
- Toward more flexible heterogeneous wireless networking (Prof. Seiichi Sampei, Osaka Univ.)

### 2.3 The 3rd Conference in October 2015

- Date: October 26<sup>th</sup> – 27<sup>th</sup>, 2015
- Venue: KKE headquarter, Tokyo
- Joint TCs: SRW
- Topics: Technical Exhibition, International Workshop
- Number of papers: 37  
(1 tutorial, 4 invited talks, 6 posters, 15 technical exhibits and 11 invited lectures)
- Number of participants: 171

The first day was kicked off with a welcome speech from Prof. Fujii, the chair of TCSR. A tutorial on spectrum measurement and modeling followed by speakers from EU and Japan. An invited session was held where the speakers focused on the latest information on 5G and Internet of Things (IoT). The second day started with poster presentations and technical exhibits. The last session was special talks on

5G and IoT given by academia and industry in EU and Japan.

### Tutorial

The title is “Spectrum Measurement and Modeling for Spectrum Awareness in Cognitive Wireless Systems”, which is given by Prof. Kenta Umebayashi, Tokyo University of Agriculture and Technology, Japan, Dr. Janne Lehtomäki, University of Oulu, Finland, Dr. Miguel López-Benítez, University of Liverpool, England, and Dr. Samuli Tiiri, Tokyo University of Agriculture and Technology. They introduce the interesting concept for spectrum operation. It is “Two-Layer Smart Spectrum Access”. Spectrum sharing layer, which is first layer, takes the responsibility for avoiding the harmful interference to primary user and exploiting the frequency spectrum by secondary user. Spectrum awareness layer, which is second layer, is dedicated for spectrum measurement and obtaining/providing useful information to secondary user.

### Invited Talks

Firstly, Dr. Sumei Sun gave a presentation entitled “Design and Optimization of 5G Heterogeneous Networks”. In this presentation, she showed the use cases in 5G communications. And she also talked about design challenges in 5G heterogeneous networks. The smart resource sharing, seamless WiFi-cellular interworking were key technologies to achieve a 5G heterogeneous networks.

Secondly, Prof. Seungwon Choi gave a presentation entitled “ETSI-Standard Architecture and Reconfiguration Process for Reconfigurable Mobile Devices”. He talked about the architecture of reconfigurable mobile device which is standardized in

WG2 of technical committee reconfigurable radio system (TC-RRS) of ETSI.

The specialist of IoT, M2M, and smart meters. They gave very interesting talks about technical trends in their technical fields as follows:

- IoT Use Cases of Social Infrastructure and Technical Standards (Dr. Taizo Kinoshita, Hitachi)
- Development trend of smart meter for gas infrastructure and its deployment in the future (Mr. Kentaro Sakamoto, Tokyo Gas.)

### Poster & Technical Exhibition

The second day morning session is featured by 15 technical exhibitions / demonstrations and 6 poster presentations on latest wireless technologies, e.g. 5G access and backhauling, mmWave, NFV, sensing/cognitive, sensor networks, etc.

### Special Sessions

Japan and international experts performed invited lectures of the topic of mmWave and IoT for 5G to share their views on global trend of latest wireless/cellular technologies. Snapshots at the special sessions are shown in Fig. 4.



Fig. 4 Snapshot at the special session

#### 2.4 The 4<sup>th</sup> Conference in January 2016

- Date: January 21<sup>st</sup> – 22<sup>nd</sup>, 2016
- Venue: Fukue bunka kaikan, Goto city, Nagasaki
- Topics: Cognitive Radio (CR) Network, Heterogeneous Network, Cross-layer Radio Technologies, Software Defined Network (SDN)
- Number of papers: 17 (Special invited talk: 1, Invited talk: 1, Special talk: 2, Regular talks 13)
- Number of participants: 54

##### Invited Talks

An invited talk was delivered by Mr. Toshiki Takeuchi (NEC) on the company's trend and activities for Mobile Edge Computing (MEC). The talk first explains about industry trends of this technology and its standardization activities at the recently established ETSI ISG. Next, the author introduces the company's activities on developing MEC prototypes.

After the invited talk, two retirement memorial lectures were respectively delivered by Prof. Yoshio Karasawa (UEC) and Prof. Yasuo Suzuki (TUAT). The first special talk titled "Conviction to a Research on Baseband Radio" introduces a CR-friendly technique called "adaptive baseband radio". The proposal adopts the principle of baseband orthogonal frequency division multiplexing (OFDM) to enable the spectrum to be controlled freely for realizing "band-free communications". The second special talk titled "Adaptive signal processing with array antenna in spatial domain" revisits the history of adaptive array antenna starting from Van Atta antenna until nowadays well-known MIMO technology. Both the two speakers finally left encouraging messages to young wireless communications researchers.

The last special invited talk of this session was addressed by Emeritus Prof. Yoshihiko Akaiwa (KIT) on "Principles of Communications and Its mathematical Expression" based on the speaker's recently published book. The talk reviewed some principles of communications technologies with emphasis on their essence and mathematical expression.

##### Evening Session

On the first day's evening, an evening session was organized and the participants discussed encourage young researchers to commit to communication research fields and specially TCSR's activities. The session was started by an encouragement talk of Dr. Kazunori Takeuchi (formerly KDDI R&D Labs.), who reviewed his research life over the last 30 years and gave advices on important research areas in the future.

The session was then continued with friendly discussions between newcomer and veteran researchers of the field.



Fig. 5 Special invited talk given by Emeritus Prof. Yoshihiko Akaiwa (Kyushu univ.)

#### 2.5 The 5<sup>th</sup> Conference in March 2016

- Date: March 2<sup>nd</sup> – 4<sup>th</sup>, 2016
- Venue: Tokyo Institute of Technology
- Joint TCs: RCS, CCS, SRW
- Topics: Mobile Communication Workshop
- Number of papers: 29 (papers to only TCSR)
- Number of participants: 376

##### Panel Session

A panel session was organized to discuss future wireless technologies for IoT. The panelists are appointed from technical committees on SR, RCS, CCS and SRW. After presentations from the panelists, a panel discussion was held with the audiences chaired by Prof. Taromaru, chair of TC on RCS. A wide area of topics was discussed from perspectives of business deployment, spectrum utilization, standardization and international backgrounds.



Fig. 6 Panelists (upper) and audiences (bottom) at the panel session on future wireless technologies for IoT

##### Special Invited Talk

Prof. Fumiyuki Adachi, whose final lecture at Tohoku Univ. due to his retirement was planned on the next day, gave a talk on his long research activities including his experience in a mobile operator. He emphasized that social deployment of research results needs a good timing, therefore it is important to always conscious about it while developing new ideas. He also stressed that enhancement of radio PHY technologies will be still required although it is not necessarily very popular now.

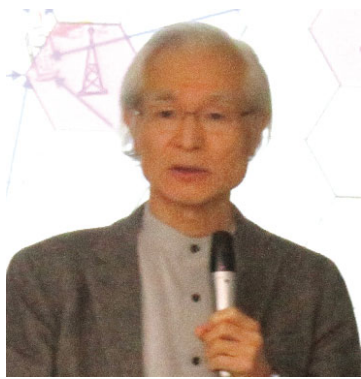

Fig. 7 Prof. Adachi (Tohoku univ.) gave a talk on the day before his final lecture at Tohoku Univ.

### Invited Talk

Four speakers, Prof. Cho (Tokyo Tech), Mr. Iura (Mitsubishi Electric), Prof. Haniz (Tokyo Tech) and Dr. Lee (NTT), who won the Best Paper Award and Best Technical Exhibition Award at SmartCom 2014 or 2015 were invited to present their updated R&D results. This session was expected to promote SmartCom 2016 to be held a half year later at Oulu, Finland.

### 3. Awards for Presentations in Fiscal Year 2014

TCSR awards to the papers presented in fiscal year 2014 were announced at the award ceremony held during the 1<sup>st</sup> conference in May 2015. The awards were given to presenters of the papers. The award recipients gave acceptance speeches.

- Best paper award  
“Detection probability based parameter adaptation for cooperative spectrum sensing using measurement-based spectrum database” (UEC)
- Research incentive award  
“High Speed Rendezvous Channel Method for Reducing Number of Control Signals” (Shinshu Univ., Fukuoka Univ., and UEC)
- Special technical award  
“Satellite Communication Networks Valid for Disaster Recovery: Development of Multi-Mode VSAT Using SDR Technology” (Tohoku Univ., Toyama National College of Tech., SKY Perfect JSAT, ISB, and Cyber Creative Institute)



Fig. 8 The three awards for Fiscal Year 2014 - winners in the right side received the certificates and plaques from Prof. Sakaguchi, the former chair of TCSR

## 4. Other Remarkable Activities

### 4.1 Society Conference

A tutorial session was organized on September 8<sup>th</sup>, 2015 jointly with TC on SR and RCS during the

Society Conference held in Tohoku Univ. The lecturer of this tutorial, Prof. Antti Tölli (Oulu Univ.), provided an understanding on the bounds and the behavior of wireless networks with inter-node interference. The tutorial session had an innovative trial of real-time video streaming of the tutorial to the Internet.

The video streaming was watched 272 times in 11 countries where 71 simultaneous connections were recorded at maximum. The organizers of the session had difficulties in operations of audience handling and contents selection due to undevelopment of clear guidelines. The TCSR achieved a lot of experiences of the real-time video streaming of academic sessions.

### 4.2 General Conference

A panel session was organized on March 15<sup>th</sup>, 2016 during the general conference held in Kyushu Univ. The title of the panel session was “Exploring New Smart Radio Technologies and Its Deployment Based on Design Thinking Approach.” The TCSR was looking for new frontier of research area and therefore focused on the design thinking as a new method for innovations.

An expert of the design thinking, Mr. Manabu Tago, was invited. With researchers of radio related technologies were also invited as panelists and had panel discussions with the audiences.

### 5. Conclusions

This paper summarized activities of the TCSR in fiscal year 2015. The TCSR is always pursuing a possibility to extend its ways by collaborating with overseas and inviting new area of experts as well as adopting new methods to organize academic conferences such as real-time video streaming.

### 6. References (Recent articles from the TCSR)

- [1] K. Sakaguchi, et al., “Technical Committee on Smart Radio - A new stage for advancing the frontiers of wireless communications technology -,” IEICE Communications Society, Global News Letter, Vol. 38, No. 3, Sep. 2014.
- [2] T. Fujii, et al., “Technical Committee on Smart Radio - A Challenge to New Frontiers and International Activities -,” IEICE Communications Society, Global News Letter, Vol. 39, No. 3, Sep. 2015.
- [3] T. Fujii, et al., “Report of SmartCom2015,” IEICE Communications Society, Global News Letter, Vol. 40, No. 1, Mar. 2016.

Web site : <http://www.ieice.org/cs/sr/eng/>  
Contact email : [sr\\_ac-sec@mail.ieice.org](mailto:sr_ac-sec@mail.ieice.org)

## Report of SmartCom 2016

### – The Third International Workshop Held in Oulu, Finland –

Kenta Umebayashi<sup>†</sup>, Takeo Fujii<sup>†</sup>, Shinsuke Ibi<sup>†</sup>, Osamu Takyu<sup>†</sup>,  
 Gia Khanh Tran<sup>†</sup>, Koji Yamamoto<sup>†</sup>, Keiichi Mizutani<sup>††</sup>,  
 Daisuke Anzai<sup>†††</sup>, Makoto Taromaru<sup>††††</sup>

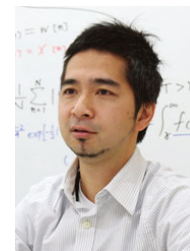

<sup>†</sup>IEICE TC on Smart Radio, <sup>††</sup>IEICE TC on Short Range Wireless Communications,  
<sup>†††</sup>IEICE TC on Healthcare and Medical Information Communication Technology,  
<sup>††††</sup>IEICE TC on Radio Communication Systems

#### 1. Introduction

SmartCom 2016 [1] was held in Oulu, Finland on May 16-17, 2016. The number of participants was 128 on the first day and 49 on the second day. The workshop was organized by IEICE Technical Committee on Smart Radio (TCSR) [2] and TC on Short Range Wireless Communications (TCSRW) [3], supported by TCs on Radio Communication Systems (TCRCS) [4], Reliable Communication and Control (TCRCC) [5], as well as Healthcare and Medical Communication Technology (TCMICT) [6].

SmartCom 2016 intended to build tight collaborations between European and Japanese researchers for contributions towards future smart communication technologies. Each session was harmonized by the session organizers.

The workshop was kicked off with two opening talks of Prof Umehira (Ibaraki Univ.) and Prof. Juntti (Univ. of Oulu), respectively (Fig. 1). Both of them had talks about future wireless networks, challenges, and current research activities from a different viewpoint, such as Europe and Asia.

Two keynote speakers Prof. Sampei (Osaka Univ.) and Dr. Yrjola (Nokia) were invited. 5 special sessions (in total 22 invited talks: EU 11, JP 11) were organized by each TC. 35 posters (EU 13, JP 22) and 6 technical exhibits (EU 3, JP 3) were presented. Each presentation was fairly evaluated by committee members for SmartCom awards. The winners were awarded in the closing session. The workshop was closed by Prof. Fujii (Univ. Electro-Comm.), the chair of TCSR.

We also had excellent social events, such as floating sauna (Fig. 2), welcome reception in Oulu city hall (Fig. 3), and banquet in the conference hotel.

Rest of the paper is organized as follows. Section 2 introduces historical background of SmartCom. Sections from 3 to 6 reports details of SmartCom 2016. Section 7 gives a plan of SmartCom 2017 to be held in Germany and section 8 concludes the paper.



Prof. Umehira (Ibaraki Univ.) Prof. Juntti (Univ. of Oulu)  
 Fig. 1 Opening talks



Fig. 2 Floating Sauna

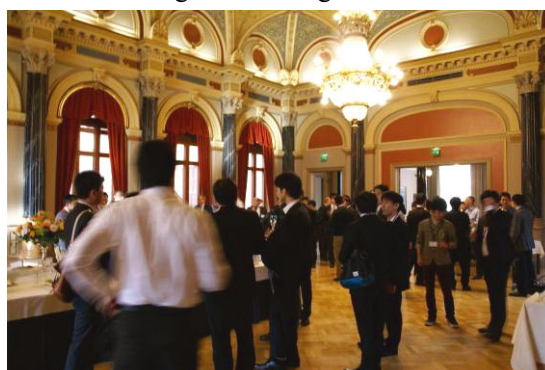

Fig. 3 Welcome reception

#### 2. Historical Background of SmartCom

IEICE needs to be more activated to increase its connectivity with international organizations, enhance its presence and achieve more members. One of the

TCSR's trials for it has been to invite key researchers from the world to TCSR's domestic regular conferences. This type of activities has been planned annually since year 2005, but limited in Japan only.

In the beginning of 2014, TCSR discussed that it is a good trial to have a regular conference outside of Japan. Focusing on Singapore where R&D on wireless communications is quite active, TCSR decided to have the first TCSR regular conference outside of Japan, named SmartCom 2014.

SmartCom 2014 was held at Institute for Infocomm Research (I2R) in Singapore on October 30<sup>th</sup>-31<sup>st</sup>, 2014. It was co-sponsored by I2R, IEEE VTS SG chapter and IEEE COMSOC Japan chapter.

The number of participants at SmartCom 2014 was 78 on the first day and 50 on the second day. It was largely beyond TCSR's expectation at its preparation stage. SmartCom 2014 acquired a number of new participants not only from Asian region, but also from Japan. It was a good surprise that so many students in Singapore participated in SmartCom2014. TCSR recorded the highest number of participants at SmartCom 2014 since TCSR was launched in 2005.

SmartCom 2015 was held in Tokyo on October 26-27, 2015 organized by IEICE TCSR and TCSRW. SmartCom 2015 was organized by 37 presentations including 1 tutorial, 4 invited talks, 6 posters, 15 technical exhibits and 11 invited lectures. The number of participants was 60 on the first day and 111 on the second day. In the SmartCom 2015, there were tutorial presentation, special session and posters which are related to EU.

### 3. Keynote Speeches

We invited two researchers, which are the frontier of latest research in wireless communication technology for keynote speech (Fig. 2). They are from academic field and industry field, respectively.

The first talk is given by Prof. Seiichi Sanpei from Osaka University, Japan. The title is "Challenges for 5G Era, --From Adaptive Processing in wireless transmission and access to Extreme Flexibility by heterogeneous networks--". Prof. Sanpei indicates the wireless communication has been considered as the bottle neck in ICT networks in 4G. However, it becomes the broadband connection with flexible functionality thanks to the enhancement of signal processing technology. For exploiting these advantages of wireless communication, a fifth generation cellular



Prof. Sanpei (Osaka Univ.)



Dr. Yrjola (Nokia)

Fig. 4 Keynote speeches

system (5G) tackles the three challenges. First one is the massive connection like internet of things (IoT). Second one is the low end-to-end latency for supporting machine control and real time applications. Third one is the dynamic access control of heterogeneous networks for satisfying the various demands of users.

The second talk is given by Dr. Seppo Yrjola from Nokia, Finland. The title is "Destination 5G - Explosion of possibilities in the programmable world present huge opportunities". Dr. Yrjola describes the explosive increasing of wireless communication links and thus the dramatic changing of life style. In 2025, it is predicted that the network connections are over 50 billion owing to IoT and machine to machine communications (M2M). The half of communication devices are smart phone and PC but the other half of them are sensor and machine. Therefore, the various applications of wireless communication like machine automation from industry, vital monitoring from medial field, and smart grid from infrastructure field, are attracting much attention. In addition, the borderless between life style and digital field are enhanced like virtual reality technology. Finally, the business model of 5G system is explained.

Both presenters had common theme which is related to 5G system. We confirmed that the worldwide research of 5G is being encouraged for starting the service in 2020.

### 4. Poster Session & Technical Exhibition

Poster session & technical exhibition sessions held in the afternoon after lunch break of both the conference days attracted many attendees coming for fruitful discussions with the technical exhibition / poster presenters. In adjunction with the sessions, product exhibitions from sponsored companies were also conducted. 6 technical exhibitions were demonstrated in the first day with real hardware e.g. SDR based fading simulator (KKE, Japan), Modular Multi-Wireless-Technology Enabled IoT Platform (CWC, Finland). Poster presentations were separated into two days each with 16 and 19 papers respectively. Presented papers focused on latest wireless technologies e.g. 5G HetNet, mmW/THz communications, signal processing, sensing/cognitive radio, IoT/sensor networks, OAM etc. All the poster presentations and technical exhibitions were evaluated by several committee members.



Fig. 5 Poster session

## 5. Special Sessions

### 5.1 Dynamic Spectrum Sharing and Cognitive Radio Technology

“Special Session: Dynamic Spectrum Sharing and Cognitive Radio Technology” are organized by Prof. Shigenobu Sasaki, Niigata University and Mr. Tuomo Hänninen, University of Oulu. Four presentations with requested basis are listed. Three of them were from European side and one of them was from Japan side. The first presentation introduced the ETSI standardization activities for spectrum sharing and software reconfiguration. Licensed Shared Access (LSA) and software defined reconfigurable radio hardware discussed in ETSI were reported. Second presentation introduced an analytical view of sharing economy business in recent spectrum shared concepts like LSA, citizens broadband radio service (CBRS) and TV white space. Third presentation introduced a future business ecosystem based on spectrum regulatory aspect. Finally, the last speaker presented a smart spectrum access concept based on spectrum measurements for targeting a novel future mobile system. This special session gave us good opportunities considering not only technologies but also business aspects for future spectrum sharing wireless world.

### 5.2 R&D Activities for 5G Mobile Communications in Europe and Japan

This session focused on R&D activities of the 5th generation mobile communications (5G) in Europe and Japan, where the 5G technologies are being researched and developed actively. Toward the realization in 2020, proof of concept using test bed is also being started. In this session, 5G key technologies and efforts for 5G systems were discussed with the five invited talks:

- R&D Activities for 5G Wireless Systems in Japan (Prof. M. Taromaru, Fukuoka Univ.)
- Nokia vision on 5G (Dr. J. Hulkkonen, Nokia)
- Forward looking 5G RF Research Outlook (Dr. Tommi Tuovinen, Univ. of Oulu)
- Joint ML Detection for Overloaded MIMO and Its Application to Non-orthogonal Multiple Access (Prof. Y. Sanada Keio Univ.)
- OULU 5G test network -- rationale, structure and rollout (Prof. A. Pouttu, Univ. of Oulu)

### 5.3 On Medical ICT Trends

Recently, research and development for medical ICT has received attention from all over the world. Also standardization for wireless body area networks (WBANs) has gained a lot of effort, e.g., via IEEE802.15.6 work. Currently, in Europe ETSI SmartBAN development is under activity.

In this session, WBAN activities in Europe and Japan was introduced, and efforts for future medical ICT systems was then discussed with the four following invited talks:

- Wearable Devices for Medical/Healthcare Applications and Body Area (Prof. Hirokazu Tanaka, Hiroshima City Univ.)

- Performance Evaluation on UWB Transmission for Implant Body Area Networks (Dr. Daisuke Anzai, Natoya Inst. Tech.)
- From BAN to SmartBAN in the future IoT (Dr. John Farserotu, CSEM)
- SmartBAN for healthcare: ETSI standardization (Prof. Lorenzo Mucchi, Univ. Florence)

### 5.4 IoT Technology Trends

Internet of Things (IoT) is one of the key technologies for the next generation societies with smart energy and resource usage, smart agriculture and factory, smart traffic systems and so on. Under such circumstances, technology exchange and discussion on IoT between Japan and Europe will become more and more important. In this special session, the researchers and developers from Japan and Europe talked about the trend of IoT technologies with the following topics:

- Wide-area Wi-SUN System for IoT (Prof. Keiichi Mizutani and Prof. Hiroshi Harada, Kyoto University)
- Telematics Techniques for the IoT (Mr. Steve Clarke, AMIHO Technology Ltd.)
- Aistin IoT Platform and Aistin Blue: Wearables and IoT Sensor Development Kit (Mr. Janne Kallio, iProtoXi Oy)
- The Contribution of Wireless Technology to the spread of IoT (Mr. Hiroshi Kume, ROHM, Takeshi Ichikawa, and Mitsuhiro Noda, LAPIS)

### 5.5 Millimeter-Wave for 5G and Beyond

“Special Session: Millimeter-Wave for 5G and Beyond” are organized by Prof. Suguru Kameda (Tohoku University, Japan) and Dr. Kei Sakaguchi (Fraunhofer HHI, Germany). Four presentations with requested basis are listed. Three of them were from Japan side and one of them was from European side. The first presentation addressed by Prof. Makoto Ando (Tokyo Tech, Japan) showed the world’s first Proof of Concept (PoC) of mmWave integrated 5G HetNet. The system employed 60GHz for access and 40GHz for DDD enabled backhauling. Based on latest research results of several EU projects, the second presentation given by Dr. Thomas Haustein (Fraunhofer HHI, Germany) shared the prospective view of mmWave communications in 5G cellular networks and pointed out not only the opportunities but challenges of the novel high frequency band for 5G and beyond. The third presenter, Mr. Shozo Okasaka (Panasonic, Japan), presented another PoC of mmWave HetNet overlaid on LTE-A which enables C/U splitting functionality. Finally, for beyond 5G, Prof. Shuhei Amakawa (Hiroshima Univ., Japan) introduced a novel development of TetraHertz-band CMOS transmitter at 300GHz enabling QAM modulation. This special session provided audiences a thorough overview of mmWave integrated 5G and the prospect on further higher frequency in beyond 5G.



## 6. SmartCom2017 in Berlin, Germany

The 4<sup>th</sup> SmartCom will be held at Berlin, Germany, in latter half of 2017. This workshop plans to be organized under the joint leadership of the technical committee on Smart Radio (SR), Japan and Fraunhofer Heinrich Hertz Institute (HHI), Germany.

## 7. Awards

The all poster presentations and technical exhibitions were evaluated by three researchers from the perspective that (1) Novelty and originality, (2) Technical content and scientific rigor, and (3) Quality of presentation.

- Best Paper Award: “Iterative Detection and Decoding of Implicitly Concatenated Channel Code in Bluetooth Low Energy,” Shinsuke Ibi, Seiichi Sampei (Osaka Univ., Japan)
- Best Paper Award: “Toward Realization of a New Wireless Transmission Technology: -- Orbital Angular Momentum (OAM) Multiplexing --,” Doohwan Lee, Hirofumi Sasaki, Hiroyuki Fukumoto, Tadao Nakagawa (NTT, Japan)
- Best Student Paper Award: “An Ultrawideband Conformal Loop Antenna for Wireless Capsule Endoscope System,” Miah Md Suzan, Katsuyuki Haneda, Clemens Icheln, Afroza Khatun (Aalto Univ., Finland), Ken-ichi Takizawa (NICT, Japan)
- Best Technical Exhibition Award: “Modular Multi-Wireless-Technology Enabled IoT,” Konstantin Mikhaylov, Juha Petajajarvi, Marko Makelainen, Anton Paatelma, Tuomo Hanninen (CWC, Finland)



Left: Prof. Ibi, Right: Dr. Lee

Fig. 6 Best Paper Awards

## 8. Conclusion

In SmartCom 2016, there were a lot of participants from academia and industry on wireless communications. So far, we have organized three SmartCom conferences held in various locations, such as Singapore, Japan, and Finland. SmartCom got more IEICE technical committees involved with its organizing committee, and extended the scope of the conference. SmartCom is now a hub of R&D for IEICE members and international researchers and it can enhance more attractive for them. The organizing committee hopes that SmartCom is connecting the researchers in the world as well as giving positive feedback to the IEICE operation.

## 9. References

- [1] SmartCom2016 website:  
<http://ieice-smartcom.info/>
- [2] IEICE TCSR website:  
<http://www.ieice.org/cs/sr/eng/>
- [3] IEICE TCSRW website:  
[http://www.ieice.org/cs/srw/index\\_e.htm](http://www.ieice.org/cs/srw/index_e.htm)
- [4] IEICE TCRCS website:  
<http://www.ieice.org/cs/rcs/jpn/>
- [5] IEICE TCRCC website:  
<http://www.ieice.org/~rcc/>
- [6] IEICE TCMICT website:  
<http://www.ieice.org/~mict/eng/index.html>

# Report on IEICE Information and Communication Technology Forum (ICTF 2016)

Michael D. Logothetis  
University of Patras, Greece



## 1. Introduction

Particularly successful was the IEICE ICTF 2016 event that took place in Patras, Greece, in July 6-8, 2016, as we have received very positive feedbacks from the participants (about 80). The conference was hosted by the University of Patras (ECE Department) at its Conference Centre. As in the past, the aim of ICTF 2016 was to serve as a proper forum for the exchange of ideas among researchers from all over the world but mainly from Europe and Japan, both from academia and industry, on advances in the broad area of Information & Communication Technology.

The conference was sponsored by (Fig. 1): IEICE, IEICE Communications Society (IEICE-CS), IEICE Electronics Society (IEICE-ES), IEICE Europe Section, Polish Association of Telecommunication Engineers (PATE), University of Patras, and DIALOG SEMICONDUCTOR S.A.



Organised by Telecommunications & Information Technology Division, ECE Department, University of Patras.

Fig. 1 Poster of IEICE ICTF 2016

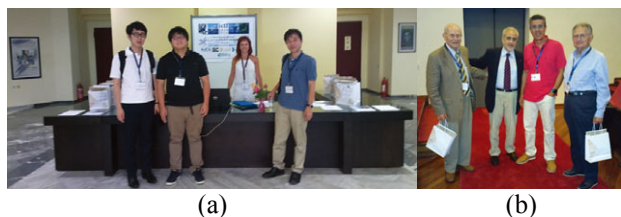

Fig. 2 (a) Students Mr. R. Morita and Mr. R. Sawada with their Prof. M. Aida, first arrivals at the registration desk (ICTF 2016 Secretary Mrs R. Doufexi). (b) Prof. Emeritus C. Georgopoulos, Prof. S. Koubias, Prof. G. Karagiannidis and Prof. Emeritus G. Kokkinakis

## 2. The Conference Program

The conference began (chaired by Prof. Michael Logothetis, *General Chair*, Dr Ioannis Moscholios, *TPC chair*, Prof. Mariusz Glabowski and Prof. Piotr Zwierzykowski, *TPC Co-chairs*) with welcoming addresses by representatives of the University of Patras (Prof. Nikos Fakotakis on behalf of the *Organizing Committee* and Prof. Stavros Koubias (Fig. 2(b)), *Head of ECE Department*, former *Rector* of the University of Patras), as well as by representatives of IEICE Europe Section (Prof. Mariusz Glabowski), PATE (Prof. Piotr Zwierzykowski), and DIALOG SEMICONDUCTOR (Dr Marios Iliopoulos). Also, representative of FITCE, the Federation of Telecommunications Engineers of the European Union (Mr. Panagiotis Exarchos), greeted the ICTF delegates. The Dean of Engineering School of University of Patras, Prof. Odysseas Koufopavlou, declared the official start of ICTF 2016.

The Technical Program included keynote, industrial, invited and ordinary conference presentations; totally, 46 presentations. They were accommodated to two days, while there was no need for parallel sessions.

Keynote speakers of the first day:

- Prof. Kenichi Mase (*Professor Emeritus, Niigata University, Japan*), "Wide-Area Deployable Ad Hoc Networks".
- Prof. George Karagiannidis (*Aristotle University of Thessaloniki, Greece*), "Robotics Facilitates Communications: Laser-Powered Drones with QoS Awareness".
- Prof. Shigeo Shioda (*Chiba University, Japan*), "Localizing Sensors from their Responses to Targets".

Keynote speakers of the second day:

- Prof. Fumiyuki Adachi (*Specially Appointed Professor, Tohoku University, Japan*), "Effective exploitation of spatial domain for 5G small-cell structured mobile networks".
- Prof. Maciej Stasiak (*Poznań University of Technology, Poland*), "Application of non full-availability models in the analysis of multi-service network systems".
- Prof. Masaki Aida (*Tokyo Metropolitan*

University, Japan), "Oscillation Model for Describing Propagation of Activities on Network Caused by Asymmetric Node Interactions".

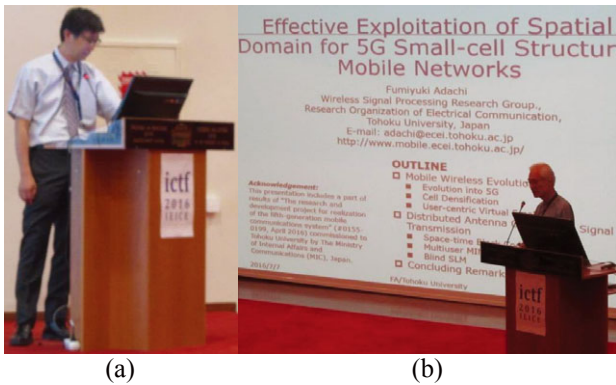

Fig. 3 (a) Prof. S. Shioda and (b) Prof. F. Adachi

Invited talks - In line to what ICTF has established, three out of five invited talks came from the industry:

- Invited Talk 1, from industry by *Dr Anna Wielgoszewska, NOKIA Bell Labs*, "Big Role of Small Cells in 5G Enterprise".
- Invited Talk 2, on Teletraffic by *Prof. Mariusz Glabowski, Poznan University of Technology, Poland*, "Analytical Modelling of Overflow Systems with Elastic Traffic".
- Invited Talk 3, from Industry by *Dr George Agapiou, Hellenic Telecommunications Organization (OTE S.A.), Greece*, "SDN and NFV for satellite infrastructures".
- Invited Talk 4, from Industry by *Dr Ioannis Papapanagiotou, Netflix, USA*, "Internet of Things (IoT): Micro-location and Smart Buildings".
- Invited Talk 5, on Power Line Communication, by *Dr Khaled Rabie, Manchester Metropolitan University, U.K.*, "On the Energy Efficiency Performance of Power Line Communication Systems".

Ordinary 35 conference papers were included in the technical program, after having reviewed by two reviewers and in some cases by three reviewers to ensure high quality and standards. The reviewers' comments were mostly positive or very positive, and only in a few cases the comments were "accept if room". On the other hand, some comments were short, while some others were very long. In any case, we hope that we have helped all authors to improve their current papers and extend their research for the future. The 35 ordinary papers created by 100 ICTF authors were accommodated to the following sessions.

Table 1 Technical Sessions of ICTF 2016

| Sessions of the 1st day:            | Sessions of the 2nd day:                                       |
|-------------------------------------|--|
| • Wireless Networks                 | • Teletraffic  |
| • Security                          | • Network Planning   |
| • Signal Processing                 | • Algorithms and Systems                                       |
| • Embedded Systems                  | • Communications and Information Processing for the Smart Grid |
| • Optical and Wireless Transmission |  |

The last session (on Smart Grid) had been predefined as a Special Session thanks to some EU projects. Another predefined special session on "5G Security" was modified to "Security", because most of the submitted papers were not focused on 5G.

The first day ended with the welcome party (at the foyer of Patras Conference Centre, next to the auditorium, Fig. 5), while the second day ended with banquet (Greek buffet) at the university park (parc de la paix); outdoor (Figs. 7 and 8).



Fig. 4 Session's Chairmen, Dr N. Passas, and Dr J. Vardakas, attending the presentation of Ms K. Rylander



Fig. 5 Photos from the welcome party (Dr Khaled Rabie and ICTF-2016 secretary Mrs Rania Doufexi)

### 3. Cultural Activity

On the last day of the conference (July 8), a cultural activity took place, by visiting the nearby imposing bridge of 2860 m (as shown in Fig. 1, it became symbol of ICTF 2016), Patras archaeological museum (Fig. 6) and Ancient Olympia (archaeological museum and site, including the ancient stadium of the Olympic Games).



Fig. 6 Entrance of Patras Archaeological Museum - Floor mosaic (Three Graces) 2-3 century CE (AD)



Fig. 7 Prof. F. Adachi, Prof. K. Mase, Prof. S. Shioda, Prof. S. Takahashi, Prof. M. Aida, Mr. R. Sawada, Mr. R. Morita, Ms A. Arno, Prof. I. Sasase, Mr. T. Matsunaga, enjoying drinks and photos before dinner



Fig. 8 Dr I. Moscholios, Dr A. Wielgoszewska, Prof. P. Zwierzykowski, Prof. M. Glabowski, Prof. M. Stasiak, Dr J. Vardakas (visible faces), enjoying drinks and discussions before dinner



Fig. 9 Guided tour at Olympia's archaeological museum spending much time in front of the famous statues of Hermes of Praxiteles and Niki (= victory) of Paionios



Fig. 10 Photos at the entrance of the ancient stadium of the Ancient Olympic Games (Prof. S. Shioda, Prof. M. Logothetis, and Prof. K. Mase)



Fig. 11 Prof. M. Stasiak, Dr K. Rylander, Prof. S. Takahashi, Prof. V. Stylianakis, Prof. M. Logothetis, at the entrance of Olympia's archaeological site



Fig. 12 (a) Relaxing under the shadow of an olive oil tree. (b) Dr J. Vardakas, Prof. P. Zwierzykowski, Dr V. Vassilakis, Prof. M. Glabowski, photographed on the hill next to Olympia's ancient stadium

#### 4. Acknowledgments

On behalf of the Organizing Committee, I would like to thank all ICTF authors, keynote and invited speakers, TPC members and additional reviewers, for their contribution to the great success of ICTF 2016.

We would like to thank IEICE and IEICE-CS which constantly sponsor financially the ICTF, so that it becomes a well-structured bridge between Europe and Japan. We ought many thanks to our Polish colleagues Mariusz Glabowski and Piotr Zwierzykowski (Professors of Poznan University of Technology) as well as to Prof. Maciej Piechowiak (Kazimierz Wielki University) who greatly assisted the ICTF 2016 event. We especially appreciate the financial support received by DIALOG SEMICONDUCTOR, a high-tech company with a big branch in Patras, Greece (staffed mostly by graduates of the University of Patras - a big branch also exists in Tokyo, Japan); thanks to this sponsorship, we offer to ICTF participants the visit to "Charilaos Trikoupis" bridge and the archaeological museums and sites. Finally, we would like to thank the authorities of the University of Patras who paid a special attention in supporting this event financially, while overcoming obstacles put by the well-known "Greek Crisis".

#### 5. IEICE ICTF 2017 Call For Papers

We are delighted to announce that the 2017 IEICE ICTF will be hosted by the Poznan University of Technology, at its Conference Center in Poznan, Poland. For more details, we invite you to visit the website: <http://www.ictf2017.ieice-europe.org/>.

# Report on 8<sup>th</sup> International Workshop on Management of the Future Internet (ManFI 2016)

Kazuhiko Kinoshita  
Workshop Co-chair, Tokushima University



## 1. Overview of ManFI 2016

The 8<sup>th</sup> International Workshop on Management of the Future Internet was held in conjunction with the IEEE/IFIP Network Operations and Management Symposium (NOMS 2016) on April 25<sup>th</sup>, 2016 in Istanbul, Turkey [1]. ManFI2016 was sponsored by the IEEE Communications Society, is endorsed by the Technical Committee on Network Operations and Management (CNOM) and the EU FP7 Flamingo Network of Excellence research project, and is in cooperation with Communications Society, IEICE.

ManFI is one of the most historical workshops in NOMS/IM. Following the success of the previous editions of this workshop, the main goal of the workshop is to present state-of-the-art research results and experience reports in the area of Future Internet Management, addressing amongst others currently important topics such as efficient network and service monitoring for the Future Internet, management of virtualized networks and services, management of IaaS, PaaS, SaaS offerings, content-aware and information-centric networks, management of software defined networks, federated management of the Future Internet, and economic based network and service management.

ManFI 2016 entitled “Management of SDN-/NFV-based systems” consists of one keynote speech, two technical sessions, and one poster session.

## 2. Sessions and Activities

Mr. Hiroaki Sato from NTT gave a speech on “NetroSphere Architecture as the Future of SDN and NFV”. It showed SDN-/NFV-based new architecture and led active discussion even after the session.



Fig. 1 Keynote Speech

A total of 14 papers from 10 countries were submitted to ManFI 2016 and of these 6 were presented in two technical sessions.

In the short paper session, two papers were delivered as poster-style presentations. In addition, two more posters are presented in cooperation with other workshops.



Fig. 2 Poster Session

Lastly, the ManFI 2016 technical program committee selected the best paper with the highest overall (paper + presentation) scores from the technical session for “Best Paper Awards”. The winner is Shusaku Shibata from Osaka University, who presented “A Fair Spectrum Sharing Method in Consideration of CoMP”.

## 3. Conclusion

On behalf of workshop co-chairs of ManFI 2016, I would like to express our appreciations to all parties involved in this conference.

## 4. Reference

[1] <http://www.manfi.org/>, Home page of ManFI.

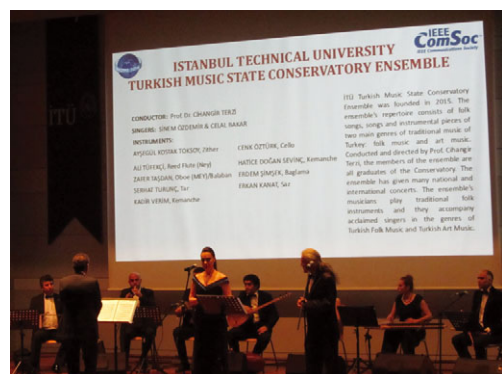

Fig. 3 Welcome Reception (NOMS)

# Report on the 8<sup>th</sup> International Conference on Ubiquitous and Future Networks (ICUFN) 2016

\*Yeong Min Jang, \*\*Sangheon Pack

\*Organizing Co-Chair of ICUFN 2016, \*\*Coordinator of ICUFN 2016



## 1. Introduction

The 8<sup>th</sup> International Conference on Ubiquitous and Future Networks (ICUFN) 2016 was held at Vienna, Austria, from July 5 to 8, 2016. This conference was supported by Korean Institute of Communications and Information Sciences (KICS) and technically sponsored by the IEEE Communication Society and IEICE Communication Society.

## 2. Organization

The organizing committee of ICUFN 2016 was formed with the Honorary Conference Co-Chairs, Pascal LORENZ (Univ. of Haute Alsace, France) and Ilyoung Chong (HUFS, Korea) and the Organizing Co-Chairs, Yeong Min Jang (Kookmin Univ., Korea), C. K. Toh (National Tsing Hua Univ., Taiwan), Zary Segall (KTH, Sweden), and Gabriele Anderst-Kotsis (Johannes Kepler University Linz, Austria).

The technical program was organized by Technical Program Committee Co-Chairs, Sungrae Cho (Chung-

Ang Univ., Korea), Xin WANG (Fudan Univ., China), Takeo Fujii (Univ. of Electro-Comms, Japan), Kun Yang (Univ. of Essex, UK), and Jaime Lloret Mauri (Universidad Politecnica de Valencia, Spain). More than 190 technical program committee (TPC) members were involved in the review process.

## 3. Conference Program

The conference consists of one opening session, one keynote speech, and 55 technical sessions. The opening session was started with a brief introduction by Prof. Yeong Min Jang (Organizing Co-Chair), following with three welcome addresses by Prof. Yongsoo Cho (President of KICS), Prof. Gabriele Anderst-Kotsis (Former President of Austrian Computer Society), and Eunhee Kwon (Former Member of Parliament, Korea).

After that, the keynote speech from Prof. Mischa Dohler (King's College London) was delivered. In the technical sessions, we had 240 presentations (selected from more than 550 submissions) with approximately 250 participants from more than 40 countries of the



Fig. 1 After Opening Session

world, such as Japan, Korea, Taiwan, China, India, Germany, Netherland, United Kingdom, Italy, Finland, Canada, USA, and so on. With regard to these technical sessions, there were 55 sessions including five poster sessions and one special session and the program covers a variety of topics on wireless and wired communication and networking technologies, including cognitive radios, wireless sensor networks, Internet of Things (IoT), broadband wireless communications, future network issues, mobile multimedia networking, Big data, Cloud computing, and other important technologies.

The Welcome Reception and Banquet were held at Imperial Riding School Renaissance Vienna Hotel. At the banquet, Prof. Ramjee Prasad (Aalborg University, Denmark) delivered a banquet speech on emerging technologies for future wireless communications. The best and excellent paper award ceremony was held simultaneously during the banquet session.

- Best Paper Award

- “Performance Limits of Cooperative Eigenvalue-Based Spectrum Sensing Under Noise Calibration,” Martijn Arts and Rudolf Mathar (RWTH Aachen University, Germany)

- Excellent Paper Award

- “A Framework for Fine-Grained Inter-Domain Routing Diversity Via SDN,” Yangyang Wang, Jun Bi, Keyao Zhang (Tsinghua University, China), and Yangchun Wu (ZTE Corporation)
- “Receiver Beacon Transmission Interval Design for Multi-Stage Wireless Sensor Networks,” Tomokazu Moriyama, Taiki Nakayama, Takeo Fujii (The University of Electro-Communications, Japan)

#### 4. Conclusion

We believe that ICUFN 2016 was a truly successful conference in the area of communication and networking. On behalf of the organizing committee, we would like to thank our sponsors, KICS, IEEE Communications Society, and IEICE-CS for their kind support to this successful event. In addition, it is our pleasure to announce that ICUFN 2017 will be held in July 2017 (for more details, please visit <http://icufn.org/>).



Fig. 2 Best Paper Award

### IEICE-CS Related Conferences Calendar

| Date                      | Conference Name  | Location                 | Note                                    |
|---------------------------|--|--------------------------|---|
| 21 Aug. –<br>25 Aug. 2017 | The 24 <sup>th</sup> Congress of the International Commission for Optics ( <b>ICO-24</b> )   | Tokyo, Japan             | Submission<br>deadline:<br>3 May 2017   |
| 22 Mar. –<br>24 Mar. 2017 | The 13 <sup>th</sup> International Symposium on Autonomous Decentralized Systems ( <b>ISADS2017</b> )  | Bangkok, Thailand        | Submission<br>deadline:<br>31 Aug. 2016 |
| 8 Mar. –<br>10 Mar. 2017  | 2017 IEEE International Conference on Computational Electromagnetics ( <b>ICCEM2017</b> )  | Kumamoto, Japan          | Submission<br>deadline:<br>16 Sep. 2016 |
| 20 Nov. –<br>23 Nov. 2016 | 5 <sup>th</sup> International Conference on Renewable Energy Research and Applications ( <b>ICRERA2016</b> )                                     | Birmingham, UK           | To be held <b>soon</b>                  |
| 24 Oct. –<br>28 Oct. 2016 | International Symposium on Antennas and Propagation ( <b>ISAP2016</b> )  | Okinawa, Japan           | To be held <b>soon</b>                  |
| 20 Oct. –<br>21 Oct. 2016 | 2016 IEICE - Workshop on Networks Optimization and Dimensioning ( <b>2016 IEICE WNOD</b> )   | Poznan, Poland           | To be held <b>soon</b>                  |
| 19 Oct.–<br>21 Oct. 2016  | International Conference on Information and Communication Technology Convergence 2016 ( <b>ICTC2016</b> )  | Jeju Island, Korea       | To be held <b>soon</b>                  |
| 5 Oct. –<br>7 Oct. 2016   | Asia-Pacific Network Operations and Management Symposium ( <b>APNOMS2016</b> )   | Kanazawa, Japan          | To be held <b>soon</b>                  |
| 25 Aug. –<br>27 Aug. 2016 | 22 <sup>nd</sup> Asia-Pacific Conference on Communication ( <b>APCC2016</b> )  | Yogyakarta,<br>Indonesia | Done                                    |
| 11 Jul. –<br>13 Jul. 2016 | IEEE Photonic Society 2016 Summer Topicals Meeting Series ( <b>IEEE Summer Topicals 2016</b> )   | Newport Beach,<br>USA    | Done                                    |
| 5 Jul. –<br>8 Jul. 2016   | The 8 <sup>th</sup> International Conference on Ubiquitous and Future Networks 2016 ( <b>ICUFN2016</b> )   | Vienna, Austria          | <b>Reported</b><br>on this issue        |
| 3 Jul. –<br>7 Jul. 2016   | 21 <sup>st</sup> Optoelectronics and Communications Conference / International Conference on Photonics in Switching 2016 ( <b>OECC/PS 2016</b> ) | Niigata, Japan           | Done                                    |
| 27 Jun. –<br>30 Jun. 2016 | The 36 <sup>th</sup> IEEE International Conference on Distributed Computing Systems ( <b>ICDCS2016</b> )   | Nara, Japan              | Done                                    |
| 14 Jun. –<br>17 Jun. 2016 | 2016 IEEE 17 <sup>th</sup> International Conference on High Performance Switching and Routing ( <b>IEEE HPSR2016</b> )                           | Yokohama, Japan          | Done                                    |
| 25 Apr. 2016              | Eighth IEEE/IFIP International Workshop on Management of the Future Internet ( <b>ManFI2016</b> )  | Istanbul, Turkey         | <b>Reported</b><br>on this issue        |

Please confirm with the following IEICE-CS web site for the latest information.  
<http://www.ieice.org/cs/conf/calendar.html>



## Special Section Calendar of IEICE Transactions on Communications

| Issue     | Special Section  | Note  |
|-----------|--|---|
| Feb. 2018 | Recent Progress in Antennas and Propagation in Conjunction with Main Topics of ISAP2016                                      | Submission due:<br>15 February 2017<br><b>See page 34</b> |
| Oct. 2017 | Opto-electronics and Communications for Future Optical Network   | Submission due:<br>30 November 2016<br><b>See page 33</b> |
| Aug. 2017 | Radio Access Technologies for 5G Mobile Communications System  | Submission due:<br>2 September 2016<br><b>See page 32</b> |
| Jul. 2017 | Smart Radio and Its Applications in Conjunction with Main Topics of SmartCom   | To be issued  |
| Jun. 2017 | Visible Light Communications in Conjunction with Topics of ICEVLC 2015   | To be issued  |
| May 2017  | No special section in this issue   |   |
| Apr. 2017 | No special section in this issue   |   |
| Mar. 2017 | No special section in this issue   |   |
| Feb. 2017 | Antenna and Propagation Technologies Contributing to Realization of Next Generation Wireless Systems                         | To be issued  |
| Jan. 2017 | Challenged Networking Technologies and Its Service Quality   | To be issued  |
| Dec. 2016 | Information Centric Networking: Paradigms, Technologies, and Applications  | To be issued  |
| Nov. 2016 | Deepening and Expanding of Information Network Science   | To be issued <b>soon</b>                                  |
| Oct. 2016 | Satellite Communication Technologies in Conjunction with Main Topics of JC-SAT2015   | To be issued <b>soon</b>                                  |
| Sep. 2016 | Integration Technologies of Ambient Intelligence and Sensor Networks   | To be issued <b>soon</b>                                  |
| Aug. 2016 | Advanced Information and Communication Technologies and Services in Conjunction with Main Topics of APCC2015                 | Vol. E99-B, No.8  |
| Jul. 2016 | No special section in this issue   |   |
| Jun. 2016 | European ICT R&D Project Activities on Broadband Access Technologies in Conjunction with Main Topics of 2015 IEICE ICT Forum | Vol. E99-B, No.6  |

Please confirm with the following IEICE web site for the latest CALL FOR PAPERS  
<http://www.ieice.org/event/ronbun-e.php?society=cs>

## Call for Papers

### — Special Section on Radio Access Technologies for 5G Mobile Communications System —

IEICE Transactions on Communications announces that it will publish a special section entitled “Special Section on Radio Access Technologies for 5G Mobile Communications System” in the **August 2017** issue.

As the fourth generation mobile communications system (4G), the Long Term Evolution (LTE)-Advanced has been already rolled out worldwide and the studies on the fifth generation mobile communications system (5G) are being activated more and more toward the launch of service in 2020. In many worldwide 5G-related organizations represented by the fifth generation mobile forum (5GMF) in Japan, novel applications, system requirements, and technologies have been discussed toward the realization of 5G. As also shown in IMT VISION finalized by ITU-R WP5D, an introduction of the massive machine type communications and the ultra-reliable and low latency communications is aimed in addition to the enhancement of the mobile broadband. In the World Radio-communication Conference 2015, higher frequency bands that are currently not used in mobile communications have been decided for being discussed as the candidate of 5G bands in WRC-19. Besides the studies on technologies for enhancing LTE-Advanced toward the realization of 5G, researches on novel wireless access technologies and new frequency bands are conducted to make steady progress beyond 5G. Standardization process of 5G has commenced in 3rd Generation Partnership Project (3GPP) since 2016 and the proposals of wireless access technologies and the performance evaluations are in full flood. In order to further promote 5G related research and development activities, a special section on radio access technologies aiming for the achievement of 5G system requirements, including the results by computer simulations, by experiment trials, and in system-level evaluations is being planned (scheduled to appear in the August 2017 issue).

#### 1. Scope

Special section aims at timely dissemination of research in the following areas. Possible topics include, but are not limited to:

- Radio interface design
- New waveform design
- Massive MIMO techniques
- Small cell technologies
- Advanced modulation and coding schemes
- Advanced retransmission control
- Advanced technologies for Multi-RAT
- Advanced interference coordination and mitigation techniques
- Advanced MIMO technologies
- Advanced technologies for flexible duplex
- Capacity/coverage split system design
- Energy-efficient radio access technologies
- Technologies for higher frequency bands
- Technologies for massive connectivity
- Technologies for small packet transmission
- Technologies for ultra-low latency
- Device to device (D2D) communications
- Wireless fronthauling and backhauling
- Advanced relay
- Advanced multiple access
- System concept and architecture
- Heterogeneous access networks

#### 2. Submission Instructions

The standard number of pages is 8. The page charges are considerably higher for extra pages. Manuscripts should be prepared according to the guidelines in the "Information for Authors." The latest version is available at the web site, [http://www.ieice.org/eng/shiori/mokuji\\_cs.html](http://www.ieice.org/eng/shiori/mokuji_cs.html). The term for revising the manuscript after acknowledgement of conditional acceptance for this special section could be shorter than that for regular issues (60 days) because of the tight review schedule.

This special section will accept papers only by electronic submission. Submit a manuscript and electronic source files (LaTeX/Word files, figures, authors' photos and biographies) via the IEICE Web site [https://review.ieice.org/regist/regist\\_baseinfo\\_e.aspx](https://review.ieice.org/regist/regist_baseinfo_e.aspx) by **2nd September 2016 (JST)**. Authors should choose the “Radio Access Technologies for 5G Mobile Communications System” as a "Journal/Section" on the online screen. Do not choose [Regular EB].

#### Contact point:

**Kazuto Yano**

**ATR Wave Engineering Laboratories**

**Tel: +81 774 95 1578**

**Email: [rca\\_ac-eb-5grat@mail.ieice.org](mailto:rca_ac-eb-5grat@mail.ieice.org)**

#### 3. Special Section Editorial Committee

Guest Editor-in-Chief: Makoto Taromaru (Fukuoka Univ.)

Guest Editors: Kazuto Yano (ATR), Tomoya Tandai (Toshiba)

Guest Associate Editors: Riichi Kudo (NTT DOCOMO), Tetsuya Yamamoto (Panasonic), Takamichi Inoue (NEC), Hiroyoshi Ishikawa (Fujitsu Labs), Koji Ishibashi (Univ Electro-Communications), Eiji Okamoto (Nagoya Institute of Tech.), Takeshi Onizawa (NTT), Takeo Ohseki (KDDI Labs), Hiroshi Nishimoto (Mitsubishi Electric), Fumiaki Maehara (Waseda Univ.), Osamu Muta (Kyusyu Univ.), Homare Murakami (NICT)

\* Authors must agree to the "Copyright Transfer and Page Charge Agreement" via electronic submission.

\* Please note that if the submitted paper is accepted, all authors, including authors of invited papers, are requested to pay for the page charges covering partial cost of publications.

\* At least one of the authors must be an IEICE member when the manuscript is submitted for review. Invited papers are an exception. We recommend that authors unaffiliated with IEICE to apply for membership.

\* For membership applications, please visit <http://www.ieice.org/eng/member/OM-appli.html>

----- Joint Special Section on Opto-electronics and Communications for Future Optical Network -----

The IEICE Transactions on Communications announces that it will publish a special section entitled "Joint Special Section on Opto-electronics and Communications for Future Optical Network " in the **October 2017** issue.

This Special Section will be published in conjunction with the 21st Optoelectronics and Communications Conference (OECC 2016), which was held in Niigata, Japan on July 3 – July 7, 2016, cosponsored by IEICE Communications Society and IEICE Electronics Society and co-organized with Photonics in Switching (PS).

The purpose of this Special Section is to present a collection of original papers that give an overview of current progress of research, development, and applications of optical communication systems and optoelectronics.

Submission of the paper presented at OECC/PS 2016 is strongly encouraged. However, presentation of the paper at OECC/PS 2016 is not mandatory for its inclusion in this Special Section. Presentation at the Conference does not ensure the acceptance of the paper. Note that the regular reviewing process will be performed for this Special Section.

### 1. Scope

The major topics of interest include:

- Core/Access Networks and Switching Subsystems (Category 1)
- Transmission Systems and Subsystems (Category 2)
- Optical Fibers, Cables and Fiber Devices (Category 3)
- Optical Active Devices and Modules (Category 4)
- Optical Passive Devices and Modules (Category 5)
- Photonics in Switching Systems and Related Technology (Category 6)

Papers in categories 1, 2, 3 and 6 should be submitted to The IEICE Transactions on Communications, and papers in categories 4 and 5 to The IEICE Transactions on Electronics.

### 2. Submission Instructions

The standard number of pages is 8. The page charges are considerably higher for extra pages. Manuscripts should be prepared according to the guideline in the "Information for Authors". The latest version is available at the web site, [http://www.ieice.org/eng/shiori/mokuji\\_cs.html](http://www.ieice.org/eng/shiori/mokuji_cs.html) (IEICE Transactions on Communications), [http://www.ieice.org/eng/shiori/mokuji\\_es.html](http://www.ieice.org/eng/shiori/mokuji_es.html) (IEICE Transactions on Electronics). The term for revising the manuscript after acknowledgement of conditional acceptance for this special section could be shorter than that for regular issues (60 days) because of the tight review schedule.

This special section will accept papers only by electronic submission. Submit a manuscript and electronic source files (TeX/Word files, figures, authors' photos and biographies) via the IEICE Web site [https://review.ieice.org/regist/regist\\_baseinfo\\_e.aspx](https://review.ieice.org/regist/regist_baseinfo_e.aspx) **by November 30, 2016 (Japan Time) for papers in categories 1, 2, 3 and 6, and January 31, 2017 (Japan Time) for papers in categories 4 and 5.** Considering the technical field of the paper, authors should choose either Opto-electronics and Communications for Future Optical Network of IEICE Transactions on Communications (**Special-OB**) or Opto-electronics and Communications for Future Optical Network of IEICE Transactions on Electronics (**Special-OC**) as a "Journal / Section" on the online screen. Do not choose [Regular-EB] or [Regular-EC].

#### Contact points:

Takehiro Tsuritani  
Photonic Network Laboratory,  
KDDI R&D Laboratories Inc.  
Tel: +81-49-278-7806, Fax: +81-49-278-7821  
Email: [ebc-oecc2016@mail.ieice.org](mailto:ebc-oecc2016@mail.ieice.org)

Haisong Jiang  
Interdisciplinary Graduate School of Engineering Sciences,  
Kyushu University  
Tel: +81-92-583-7604, Fax: +81-92-583-7898  
E-mail: [jiang@asem.kyushu-u.ac.jp](mailto:jiang@asem.kyushu-u.ac.jp)

### 3. Special Section Editorial Committee

#### Opto-electronics and Communications for Future Optical Network of IEICE Transactions on Communications

**Guest Editor-in-Chief:** \* Masatoshi Suzuki (KDDI Labs.)

**Guest Editors:** Takehiro Tsuritani (KDDI Labs. ), Akihide Sano (NTT)

**Guest Associate Editors:** Yasuhiko Aoki (Fujitsu Labs.), Shoichiro Matsuo (Fujikura), Naoya Wada (NICT), Hiroaki Harai (NICT), Ryo Takahashi (NTT), Hidehisa Tazawa (Sumitomo)

#### Opto-electronics and Communications for Future Optical Network of IEICE Transactions on Electronics

**Guest Editor-in-Chief:** Kiichi Hamamoto (Kyusyu Univ.)

**Guest Editor:** Haisong Jiang (Kyusyu Univ.)

**Guest Associate Editors:** Tomoyuki Miyamoto (Tokyo institute of technology), Masaya Notomi (NTT), Kenji Sato (NEC), Hirohito Yamada (Tohoku Univ.), Mitsuteru Ishii (NTT)

\* Authors must agree to the "Copyright Transfer and Page Charge Agreement" via electronic submission.

\* Please note that if the submitted paper is accepted, all authors, including authors of invited papers, are requested to pay for the page charges covering partial cost of publications.

\* At least one of the authors must be an IEICE member when the manuscript is submitted for review. Invited papers are an exception. We recommend that authors unaffiliated with IEICE apply for membership. For membership applications, please visit

<http://www.ieice.org/eng/member/OM-appli.html>

## Call for Papers

# ----- Special Section on Recent Progress in Antennas and Propagation in Conjunction with Main Topics of ISAP2016 -----

The IEICE Transactions on Communications announces that it will publish a special section entitled "Special Section on Recent Progress in Antennas and Propagation in Conjunction with Main Topics of ISAP2016" in **February 2018**.

The objective of this special section is to discuss the antenna and propagation technologies related to progressing technologies for 5G mobile communication systems, MIMO, PAN/BAN, and wireless power transmission and so on. The 2016 International Symposium on Antennas and Propagation (ISAP2016) will be held in Ginowan, Okinawa, Japan during October 24 – 28, 2016, which aims at providing an international forum for exchanging information on such progress of research and development in antennas, propagation, electromagnetic wave theory, and the related fields. By taking this opportunity the special section has been planned to publish papers on advanced technologies in antennas, propagation and the related fields. The special section seeks for submission particularly from, but not limited to, the authors of ISAP2016.

## 1. Scope

This special section aims at timely dissemination of research in these areas. Possible topics include, but are not limited to:

### Antennas

- Small Antennas and RF Sensors
- Antennas for Mobile and Wireless Applications
- Broadband and Multi-band Antennas
- Tunable and Reconfigurable Antennas
- 2D and 3D Printed Antennas and Arrays
- Millimeter-wave, THz and Optical Antennas
- Active and On-Chip Antennas
- Adaptive and Smart Antennas
- Antenna Theory and Design
- Antenna Measurements
- Other related topics

### Propagation

- Indoor and Mobile Propagation
- Millimeter-wave, THz and Optical propagation
- Machine-to-Machine/Infrastructure Propagation
- Channel Sounding and Channel Estimation
- Propagation Measurement Techniques
- Terrestrial, Earth-Space, and Ionospheric Propagation
- Propagation Fundamentals,
- DOA Estimation
- Remote Sensing and Radar
- Other related topics

### Electromagnetic-wave Theory

- Computational Electromagnetics
- Optimization Methods in EM Problems
- Frequency Selective Surfaces and Filters
- EBG, Metamaterials, and Applications
- Time-Domain Techniques
- Scattering, Diffraction, and RCS
- Inverse and Imaging Techniques
- Passive and Active Components
- Nano-Electromagnetics
- Other related topics

### AP-related Topics

- MIMO and Its Applications
- Antenna Systems for Mobile Communications
- Broadcasting and Receiving Technologies
- Wireless Power Transfer Technologies
- Wearable Device Networks and Medical Applications
- Sensor Networks and Adhoc Systems
- RFID and Applications,
- EMC/EMI Technologies
- Other related topics

## 2. Submission Instructions

The standard number of pages is 8. The page charges are considerably higher for extra pages. Submissions of "letters" are not accepted. Manuscripts should be prepared according to the guideline in the "Information for Authors". The latest version is available at the web site, [http://www.ieice.org/eng/shiori/mokuji\\_cs.html](http://www.ieice.org/eng/shiori/mokuji_cs.html). The period for revising the manuscript after acknowledgement of conditional acceptance for this special section could be shorter than that for regular issues (60 days) because of the tight review schedule.

This special section will accept only papers by electronic submission. Submit a manuscript and electronic source files (LaTeX/Word files, figures, authors' photos and biography) via the IEICE Web site [https://review.ieice.org/regist/regist\\_baseinfo\\_e.aspx](https://review.ieice.org/regist/regist_baseinfo_e.aspx) by **February 15th, 2017 (JST)**. Authors should choose the Recent Progress in Antennas and Propagation in Conjunction with Main Topics of ISAP2016 as a "Journal/Section" on the online screen. Do not choose [Regular-EB].

**Contact Person: Toru Takahashi**  
**Information Technology R&D Center, Mitsubishi Electric Corporation**  
**Tel: +81-467-41-2155, Email: [ap\\_ac-isap2016ss@mail.ieice.org](mailto:ap_ac-isap2016ss@mail.ieice.org)**

## 3. Special Section Editorial Committee

**Guest Editor-in-Chief:** Jiro Hirokawa (Tokyo Tech)

**Guest Editors:** Toru Takahashi (Mitsubishi Electric), Kentaro Nishimori (Niigata Univ.)

**Guest Associate Editors:** Takuji Arima (Tokyo Univ. of Agric. and Tech.), Koichi Ichige (Yokohama Natl. Univ.), Shinichiro Ohnuki (Nihon Univ.), Noaki Kita (NTT), Koshiro Kitao (NTT DOCOMO), Shigeki Takeda (Ibaraki Univ.), Masayuki Nakano (KDDI), Hiroshi Hirayama (Nagoya Inst. of Tech.), Takeshi Fukusako (Kumamoto Univ.), Mitoshi Fujimoto (Univ. of Fukui), Naobumi Michishita (Natl. Defense Acad.), Manabu Yamamoto (Hokkaido Univ.)

\*Authors must agree to the "Copyright Transfer and Page Charge Agreement" via electric submission.

\* Please note that if accepted, all authors, including authors of invited papers, are requested to pay for the page charges covering partial cost of publications.

\* At least one of the authors must be an IEICE member when the manuscript is submitted for review. Invited papers are an exception. We recommend that authors unaffiliated with IEICE apply for membership. For membership applications, please visit the web-page, <http://www.ieice.org/eng/member/OM-appli.html>.

**IEICE** Welcome to the IEICE Overseas Membership Page URL:<http://www.ieice.org/>

**Membership for Overseas Candidates:** Overseas Members may opt to join **one IEICE Society of their choice** and may request to receive the **IEICE Transactions of online version** of that Society. Furthermore, Overseas Members may request to receive the IEICE Journal (written in Japanese) and Transactions (published in paper) at an additional cost. Similar services are available to **Overseas Student Members**. Voting privileges in the IEICE election do not apply to Overseas Members. Note that the Overseas Membership applies only to candidates who reside outside of Japan and who have citizenship in countries other than Japan.

**OMDP (Overseas Membership Development Program):** OMDP is provided for candidates **from countries/areas in Asia(except Republic of Korea and Taiwan), Africa, Central America, and South America**. This program is designed so that IEICE can contribute to and support the progress of science and technology throughout the world. Scientists and engineers in these countries/areas are encouraged to apply to the program.

#### ● IEICE Societies and Publications

| Society   | Transactions                 | Editorial Subject Indexes  |
|---|------------------------------|--|
| <b>A</b><br>(Fundamentals of Electronics, Communications and Computer Sciences) | EA (English)<br>A (Japanese) | Engineering Acoustics, Noise and Vibration, Speech and Hearing, Ultrasonics, Digital Signal Processing, Analog Signal Processing, Systems and Control, Nonlinear Problems, Circuit Theory, VLSI Design Technology and CAD, Numerical Analysis and Optimization, Algorithms and Data Structures, Graphs and Networks, Reliability, Maintainability and Safety Analysis, Cryptography and Information Security, Information Theory, Coding Theory, Communication Theory and Signals, Spread Spectrum Technologies and Applications, Mobile Information Network and Personal Communications, Intelligent Transport System, Image, Vision, Computer Graphics, Language, Thought, Knowledge and Intelligence, Human Communications, Neural Networks and Bioengineering, Multimedia Environment Technology, Communication Environment and Ethics, Concurrent Systems, Measurement Technology, General Fundamentals and Boundaries  |
| <b>B</b><br>(Communications)  | EB (English)<br>B (Japanese) | Fundamental Theories for Communications, Devices/Circuits for Communications, Transmission Systems and Transmission Equipment for Communications, Optical Fiber for Communications, Fiber-Optic Transmission for Communications, Switching for Communications, Switching for Mobile Communications, Network, Network Management/Operation, Internet, Wireless Communication Technologies, Terrestrial Radio Communications, Satellite Communications, Optical Wireless Communications, Antennas and Propagation, Electromagnetic Compatibility (EMC), Sensing, Navigation, Guidance and Control Systems, Energy in Electronics Communications, Terminals for Communications, Multimedia Systems for Communications, Broadcast Systems, Integrated Systems for Communications, Space Utilization Systems for Communications   |
| <b>C</b><br>(Electronics)   | EC (English)<br>C (Japanese) | Electromagnetic Theory, Lasers, Quantum Electronics, Optoelectronics, Microwaves, Millimeter-Waves, Ultrasonic Electronics, Electronic Circuits, Electronic Materials, Organic Molecular Electronics, Electronic Components, Electromechanical Devices and Components, Semiconductor Materials and Devices, Integrated Electronics, Electron Tubes, Vacuum and Beam Technology, Electronic Displays, Superconducting Electronics, Storage Technology, Electronic Instrumentation and Control   |
| <b>D</b><br>(Information and Systems)   | ED (English)<br>D (Japanese) | Computation and Computational Models, Automata and Formal Language Theory, Algorithm Theory, Complexity Theory, Computer Components, VLSI Systems, Computer Systems, Fundamentals of Software and Theory of Programs, System Programs, Software Engineering, Database, Contents Technology and Web Information Systems, Data Mining, Networks, Dependable Computing, Application Information Security, Distributed Cooperation and Agents, Artificial Intelligence and Cognitive Science, Human-computer Interaction, Office Information Systems, e-Business Modeling, Educational Technology, Rehabilitation Engineering and Assistive Technology, Pattern Recognition, Speech and Hearing, Image Processing and Video Processing, Image Recognition, Computer Vision, Computer Graphics, Multimedia Pattern Processing, Natural Language Processing, Biocybernetics, Neurocomputing, Biological Engineering, Music Information Processing, Kansei Information Processing, Affective Information Processing |
| <b>Journal of IEICE (written in Japanese only)</b>                              |                              |  |

#### ● Membership Charges (<http://www.ieice.org/eng/member/OM-appli.html#c>)

Basic Membership Charge is as follows. It will change the term when you join IEICE. Please refer to the above website.

#### Basic Membership Charge (UNIT : Japanese YEN)

| Service coverage for overseas members | Admission charge | Online Version   |   | Paper Version (optional)      |
|---------------------------------------|------------------|--|---|-------------------------------|
|                                       |                  | Registration of the first society (includes its online version transactions) | Registration of additional societies (includes its online version transactions) | Journal (written in Japanese) |
| Member (overseas)                     | 1,400            | 7,000  | 3,500 / 1society  | 6,000                         |
| Member (overseas) with OMDP*          | 1,000            | 5,000  | 3,000 / 1society  | 6,000                         |
| Student member (overseas)             | -                | 2,000  | 2,000 / 1society  | 6,000                         |
| Student member (overseas) with OMDP*  | -                | 1,000  | 1,500 / 1society  | 6,000                         |

#### NOTE

1. You need to choose one Society, and you can subscribe Transactions online of your registered society.

Example: If you want to subscribe to Transaction of EA, please check **Society Registration** as "A", and your membership fee amounts to 7,000 yen / 5,000 yen.

2. If you want to register other Societies and Transaction of web version, please check "Additional Society registration".

Example: If you want to subscribe to Transaction of EA and EB, please check **Society Registration** as "A", **Additional Society registration (optional)** as "B". Your membership fee amounts to 7,000+3,500 yen / 5,000+3,000 yen.

3. If you want to subscribe to one Transaction of paper version, please check "Additional Transaction subscription (published in paper)".

Example: If you want to subscribe to Transaction of EC in paper version additionally, please check **Society Registration** as "A", and **Additional Transaction subscription (in paper version)** as "C" or as "EC". Your membership fee amounts to 7,000+4,000 yen / 5,000+4,500 yen.

4. If you want to change membership from Member (In Japan) to Overseas Member, you don't need to pay an Entrance charge.

#### ● Optional Rapid Mailing Service

Surface mail charge is included in the membership charge. Optional rapid mailing service is available by air mail or surface air lifted (SAL) mail. The additional charge per year periodical depends on the mailing address, as shown in the right table.

| Areas  | Air mail   | SAL mail  |
|--|------------|-----------|
| Asia; Guam; Midway islands                                   | 5,600 yen  | 3,200 yen |
| Oceania; Near & Middle East; North & Central America; Europe | 7,800 yen  | 4,400 yen |
| Africa; South America  | 11,000 yen | 5,600 yen |

Please contact the IEICE Membership Section: E-mail:[member@ieice.org](mailto:member@ieice.org) FAX: +81 3 3433 6659 Please fill out the application form printed on the next page.

## IEICE Overseas Membership Application Form

URL <http://www.ieice.org/eng/member/OM-appli.html> E-mail [member@ieice.org](mailto:member@ieice.org) FAX +81-3-3433-6659

◆ **Please type or print in English. The deadline for submitting application form is the 1<sup>st</sup> day of every month.**

### Personal Information

**Full name:** First name \_\_\_\_\_ Middle name \_\_\_\_\_ Last name \_\_\_\_\_ **Nationality:** \_\_\_\_\_  Male  
 Female  
 Prof.  Dr.  Mr.  Ms. **Place of birth:** \_\_\_\_\_ **Date of birth:** \_\_\_\_\_  
 Day \_\_\_\_\_ Month \_\_\_\_\_ Year \_\_\_\_\_

### Mailing Address

Home  Office

Name of Company/School/College \_\_\_\_\_ Department/Section \_\_\_\_\_  
 Street \_\_\_\_\_ City \_\_\_\_\_ State/Province \_\_\_\_\_  
 Postal code \_\_\_\_\_ Country \_\_\_\_\_  
 TEL \_\_\_\_\_ FAX \_\_\_\_\_ E-mail \_\_\_\_\_

### Academic Background

The highest academic degree:  Ph.D.  Masters  Bachelors  Others: \_\_\_\_\_

University/college/school of the highest academic degree \_\_\_\_\_ Month & year of graduation \_\_\_\_\_

(For Student Member) Academic degree which will be conferred on you \_\_\_\_\_ Month & year when the degree will be conferred on you \_\_\_\_\_

### Application Information

**Membership:** I want to apply for the following membership (check one item!)

- Member (Overseas)  Student Member (Overseas)  
 ◆ If you want to apply for OMDP, please check;  OMDP (Overseas Membership Development Program)

**Society registration (Membership fee includes one Society of Transaction of Online version.):**

- A: Engineering Sciences  B: Communications  C: Electronics  D: Information and Systems

**Additional Society (optional):**  A: Engineering Sciences  B: Communications  C: Electronics  D: Information and Systems

**Additional Transactions of paper version (optional):**

- EA: Fundamentals  EB: Communications  EC: Electronics  ED: Information and Systems  
 A: Fundamentals (Japanese)  B: Communications (Japanese)  C: Electronics (Japanese)  D: Information and Systems (Japanese)

**Journal subscription (optional):**  (Japanese)

### Remittance

Remittance is available only in **Japanese yen** by a **credit card**.

Admission charge.....¥ \_\_\_\_\_ Journal subscription (optional).....¥ \_\_\_\_\_  
 Annual charge.....¥ \_\_\_\_\_ Mailing option:  Air mail.....¥ \_\_\_\_\_  
 Additional Society (optional) ..... ¥ \_\_\_\_\_  SAL mail.....¥ \_\_\_\_\_  
 Additional Transactions (optional).....¥ \_\_\_\_\_ **Total**.....¥ \_\_\_\_\_

Credit Card:  UC  Master Card  VISA  JCB  American Express

Card number: 

|  |  |  |  |  |  |  |  |  |  |  |  |  |  |  |  |  |  |  |  |
|--|--|--|--|--|--|--|--|--|--|--|--|--|--|--|--|--|--|--|--|
|  |  |  |  |  |  |  |  |  |  |  |  |  |  |  |  |  |  |  |  |
|--|--|--|--|--|--|--|--|--|--|--|--|--|--|--|--|--|--|--|--|

Expiry date: \_\_\_\_\_ / \_\_\_\_\_ Credit Card Holder: \_\_\_\_\_ Signature: \_\_\_\_\_  
 Year \_\_\_\_\_ Month \_\_\_\_\_

### Endorsement

Endorsements by one IEICE Member application is required. If it is difficult to find endorsers, please contact the IEICE Membership Activities Section by sending this sheet, and we will help you.

I recommend this applicant for IEICE membership.

Endorser's name \_\_\_\_\_ Membership number \_\_\_\_\_ Endorser's signature \_\_\_\_\_ Date \_\_\_\_\_

**IEICE-CS Overseas Membership with Special Annual Fees  
for Sister Society Members**

To foster the cooperation between the Sister Society and the IEICE Communications Society (IEICE-CS), the Sister Society agreement enables members of each institution to become members of both societies by granting special annual fees.

A 10% - 20% discount\* of the annual fees will be granted to the sister society members to become the IEICE-CS overseas members. The discounted fees will be applied for the individual members when the new membership is starting or the current membership is renewing.

\* The discount does not apply to the optional items and services i.e. “Additional Society”, “Additional Transactions of paper version” and “Rapid Mailing Service”.

----- Please send the following Sister Society membership information, together with membership application form in the next page. -----

**Sister Society membership information**

***To apply discount rates for this IEICE-CS Sister Society member’s application, please indicate your Sister Society Membership number below, and attach a copy of your Sister Society Membership certificate or card to this form.***

Sister Society:     IEEE ComSoc         KICS         VDE-ITG

Membership number (Member): \_\_\_\_\_

Copy of Membership certificate or Membership card:

(Attached here)

### IEICE Overseas Membership Application Form for IEICE-CS Sister Society Members

URL <http://www.ieice.org/eng/member/OM-appli.html> E-mail [member@ieice.org](mailto:member@ieice.org) FAX +81-3-3433-6659

**◆ Please type or print in English. The deadline for submitting application form is the 1st day of every month.**

#### Personal Information

Male  
 Female  
**Full name:** \_\_\_\_\_ **Nationality:** \_\_\_\_\_  
First name Middle name Last name  
 Prof.  Dr.  Mr.  Ms. **Place of birth:** \_\_\_\_\_ **Date of birth:** \_\_\_\_\_  
Day Month Year

#### Mailing Address

Home  Office

Name of Company/School/College \_\_\_\_\_ Department/Section \_\_\_\_\_  
Street \_\_\_\_\_ City \_\_\_\_\_ State/Province \_\_\_\_\_  
Postal code \_\_\_\_\_ Country \_\_\_\_\_  
TEL \_\_\_\_\_ FAX \_\_\_\_\_ E-mail \_\_\_\_\_

#### Academic Background

The highest academic degree:  Ph.D.  Masters  Bachelors  Others: \_\_\_\_\_

University/college/school of the highest academic degree \_\_\_\_\_ Month & year of graduation \_\_\_\_\_

#### Application Information

**Membership:** I want to apply for the following membership\*:

- Member  Member (including Japanese Journal subscription)
- Student Member  Student Member (including Japanese Journal subscription)

*\*Membership applies only to applicant who reside outside of Japan and who have non-Japanese citizenship.*

◆ If you want to apply for OMDP (Overseas Membership Development Program), please check;  OMDP

**Society registration (Membership fee\*\* includes one Society of Transaction of Online version.):**

B: Communications  
*\*\*Discount rate is applied to this IEICE-CS Sister Society Member's application.*

----- Discount rate is not applied for the following optional items. -----

**Additional Society (optional):**  A: Engineering Sciences  C: Electronics  D: Information and Systems

#### Remittance

Remittance is available only in Japanese yen by a credit card

Admission charge.....¥ \_\_\_\_\_ Journal subscription (optional).....¥ \_\_\_\_\_  
Annual charge.....¥ \_\_\_\_\_ Mailing option:  Air mail.....¥ \_\_\_\_\_  
Additional Society (optional) .....¥ \_\_\_\_\_  SAL mail.....¥ \_\_\_\_\_  
**Total.....¥ \_\_\_\_\_**

Credit Card:  UC  Master Card  VISA  JCB  American Express

Card number: 

|  |  |  |  |  |  |  |  |  |  |  |  |  |  |  |  |  |  |  |  |  |  |  |  |  |  |  |  |  |  |  |  |
|--|--|--|--|--|--|--|--|--|--|--|--|--|--|--|--|--|--|--|--|--|--|--|--|--|--|--|--|--|--|--|--|
|  |  |  |  |  |  |  |  |  |  |  |  |  |  |  |  |  |  |  |  |  |  |  |  |  |  |  |  |  |  |  |  |
|--|--|--|--|--|--|--|--|--|--|--|--|--|--|--|--|--|--|--|--|--|--|--|--|--|--|--|--|--|--|--|--|

Expiry date: \_\_\_\_ / \_\_\_\_ / \_\_\_\_    Credit Card Holder: \_\_\_\_\_    Signature: \_\_\_\_\_  
Year      Month

#### Endorsement

The following endorsement for this Sister Society member's application will be given by an IEICE-CS director (any related action of endorsement by applicant is not necessary if a copy of your Sister Society Membership certificate or card is indicated).

I recommend this applicant for IEICE membership.  
(Director of Planning and Member Activities, IEICE-CS)

Endorser's name \_\_\_\_\_ Membership number \_\_\_\_\_ Endorser's signature \_\_\_\_\_ Date \_\_\_\_\_



# IEICE Communications Society - GLOBAL NEWSLETTER

## Submission Guideline

First version in only Japanese: May 30, 2008  
Second version in only Japanese: Feb. 13, 2009  
Third version in only Japanese: Jul. 22, 2010  
Forth version in English and Japanese: Mar. 8, 2011  
Ver 5.0 : August 10 2013

### 1. About GLOBAL NEWSLETTER

The Institute of Electronics, Information and Communication Engineers Communications Society (IEICE-CS) GLOBAL NEWSLETTER has been established since 2002. We quarterly publish an English newsletter every March, June, September, and December.

#### 1.1. Goal

Our goal is to share information between overseas/foreign members and other members in IEICE-CS as a global activity, and to show IEICE presence internationally.

#### 1.2 Category of Articles

- 1) Messages from President/Vice President
    - An inaugural message from CS President is published once per year in June. Message from CS Vice President is published properly.
  - 2) IEICE-CS Activities Now
    - IEICE General/Society Conference information/reports
    - Activities of Technical Committees
    - International activities of the society
  - 3) IEICE-CS Related Conferences Reports
    - Information/reports on IEICE-CS related conferences
    - IEICE-CS Conferences Calendar (\*)
  - 4) Others
    - Essays, Laboratory activity reports, Technology reports, Messages from overseas/foreign members, etc.
    - Information from Sister Societies
    - Special topics (\*)
  - 5) IEICE-CS Information
    - Call for papers
    - From editor's desk (\*)
- \*: planned / written by IEICE-CS Directors, Planning and Members Activities

### 2. Major notes for Contribution

Basically, IEICE-CS members and readers can contribute articles. IEICE-CS Directors, Planning and Members Activities may ask non-IEICE-CS members to contribute articles. The articles should be fruitful and profitable for IEICE-CS members, **NOT** for particular organization. IEICE-CS Directors, Planning and Members Activities may not accept an article for publication if it does not follow this guideline.

#### 2.1 Template and Language

Please use template downloadable at the URL:  
[http://www.ieice.org/cs/pub/global\\_howto.html](http://www.ieice.org/cs/pub/global_howto.html)  
Please use English for all articles.

#### 2.2 Number of pages

Two to four pages are preferable. One page article is also acceptable. The maximum number of pages is eight. When you try to entry a contribution with five to eight pages, you need to negotiate with IEICE-CS Directors, Planning and Members Activities.

### 3. Copyright

The copyrights of all articles in the GLOBAL NEWSLETTER should belong to the IEICE. However, the original authors retain the right to copy, translate or modify their own manuscripts. In cases when a manuscript is translated into another language or when any portion of the manuscript is to be submitted to another publication, authors

should register the action with the IEICE, and the original manuscript should be clearly cited in the publications. Please see a web site related to IEICE provisions on copyright.

<http://www.ieice.org/eng/about/copyright.html>

#### 4. Publication fee / Manuscript fee

No publication fee and no manuscript fee for all articles.

#### 5. Schedule

Standard editing schedule is as follows. Please note that the schedule may vary due to public holidays or other circumstances. The exact deadlines are indicated in call for newsletters.

|                                    |                            |                            |                            |                             |
|------------------------------------|----------------------------|----------------------------|----------------------------|-----------------------------|
| Publication date                   | 1 <sup>st</sup> , Mar.     | 1 <sup>st</sup> , Jun.     | 1 <sup>st</sup> , Sept.    | 1 <sup>st</sup> , Dec.      |
| Call for newsletters               | 1 <sup>st</sup> Mon., Dec. | 1 <sup>st</sup> Mon., Mar. | 1 <sup>st</sup> Mon., Jun. | 1 <sup>st</sup> Mon., Sept. |
| Contribution entry                 | 4 <sup>th</sup> Fri., Dec. | 4 <sup>th</sup> Fri., Mar. | 4 <sup>th</sup> Fri., Jun. | 4 <sup>th</sup> Fri., Sept. |
| Submission of Manuscript/Copyright | 3 <sup>rd</sup> Fri., Jan. | 3 <sup>rd</sup> Fri., Apr. | 3 <sup>rd</sup> Fri., Jul. | 3 <sup>rd</sup> Fri., Oct.  |

##### 5.1 Call for Newsletters

IEICE-CS Directors, Planning and Members Activities will give you the information on call for newsletters.

##### 5.2 Contribution Entry

You should send **information on title, summary(around 50 words or less) and number of page** to IEICE-CS Directors, Planning and Members Activities by e-mail.

E-mail: [cs-gnl@mail.ieice.org](mailto:cs-gnl@mail.ieice.org)

##### 5.3 Submission of Manuscript

You should send a manuscript both in word file and pdf file to IEICE-CS Directors, Planning and Members Activities by e-mail.

E-mail: [cs-gnl@mail.ieice.org](mailto:cs-gnl@mail.ieice.org)

##### 5.4 Submission of COPYRIGHT TRANSFER FORM

COPYRIGHT TRANSFER FORM can be downloaded at:

[http://www.ieice.org/cs/pub/global\\_howto.html](http://www.ieice.org/cs/pub/global_howto.html)

Signed **COPYRIGHT TRANSFER FORM** should be sent by one of the following ways:

- By email.
- By facsimile.

Address to send:

- In case of email: [cs-gnl@mail.ieice.org](mailto:cs-gnl@mail.ieice.org)
- In case of facsimile:

Name: Publications Department, IEICE

Facsimile: +81-3-3433-6616, Phone: +81-3-3433-6692

#### 6 Contact Point

IEICE-CS Directors, Planning and Members Activities in charge of IEICE-CS GLOBAL NEWSLETTER, [cs-gnl@mail.ieice.org](mailto:cs-gnl@mail.ieice.org)

## From Editor's Desk

### ● IEICE Society Conference 2016 Held in Sapporo

IEICE Society Conference will be held at Hokkaido University, Sapporo, September 20<sup>th</sup> – 23<sup>rd</sup>, 2016. Complete English Sessions are also scheduled in the conference for the globalization of IEICE's academic activities. We would like to remind readers to consider joining in the conference. Please check out the latest information on the IEICE web site at:

[http://www.toyoag.co.jp/ieice/E\\_S\\_top/e\\_s\\_top.html](http://www.toyoag.co.jp/ieice/E_S_top/e_s_top.html)

### ● A New Member of Editorial Staff Joined

A new member joined the editorial staff in June this year and has been engaged in publication operations from this issue. Through the publication of GLOBAL NEWSLETTER (GNL), we, three of editorial staff, are continuously trying to aim at the goal to share information between overseas/foreign members and other members in IEICE-CS as a global activity, and also to show IEICE presence internationally. For such goal, we welcome your contribution of article submissions to GNL. Category of the articles in GNL includes also Essays, Laboratory activity reports, Technology reports, Messages from overseas/foreign members, etc. For article submission, please refer to the Submission Guideline of IEICE-CS GLOBAL NEWSLETTER:

[ENG] [http://www.ieice.org/cs/pub/global\\_howto.html](http://www.ieice.org/cs/pub/global_howto.html)

[JPN] [http://www.ieice.org/cs/jpn/pub/global\\_howto.html](http://www.ieice.org/cs/jpn/pub/global_howto.html)

IEICE-CS GLOBAL NEWSLETTER Editorial Staff

#### Editorial Staff of this issue

No special order is observed.



**Moriya NAKAMURA**

Meiji University

Department of Electronics and Bioinformatics, School of Science and Technology

*Director, Planning and Member Activities, IEICE Communications Society*



**Manabu KAI**

Fujitsu Laboratories, Ltd.

Network Systems Laboratory

*Director, Planning and Member Activities, IEICE Communications Society*



**Takashi DATEKI**

Fujitsu Laboratories, Ltd.

Network Systems Laboratory

*Director, International Publication, IEICE Communications Society*

To Probe Further and Keep Up-to-date with Communication Technologies

# IEICE Communications Society

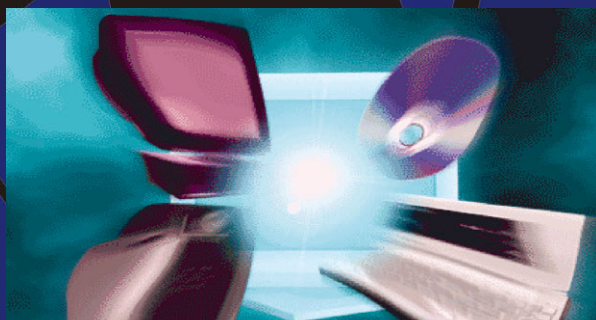

## IEICE Society Conference 2016

20-23 September 2016

Hokkaido University, Sapporo Campus

Every autumn, each Society organizes a Society Conference to provide a forum where members can present their study results and exchange views. At present, four of the Societies -- the Engineering Sciences Society, the NOLTA Society, the Communications Society, and the Electronics Society -- hold their Society Conferences as a joint event. The Communications Society Conference includes English-language sessions in addition to the Japanese-language sessions.

Please check out the latest information on the IEICE web site at:

[http://www.toyoag.co.jp/ieice/E\\_S\\_top/e\\_s\\_top.html](http://www.toyoag.co.jp/ieice/E_S_top/e_s_top.html)



IEICE Knowledge Discovery®

With I-Scover (<http://i-scover.ieice.org>), you can easily search articles including related keywords efficiently. I-Scover covers about 215,000 articles from IEICE transactions, IEICE technical reports, proceedings of the IEICE General/Society conferences and some IEICE related international conferences.

(\*) Depending on material, IEICE membership account, password attached to proceedings DVD, etc. may be required to view PDF contents.



Kikai-Shinko-Kaikan Bldg.,5-8, Shiba-Koen, 3, Minato-ku, Tokyo, 105-0011, JAPAN

Web: <http://www.ieice.org> TEL: +81-3-3433-6691 FAX: +81-3-3433-6659

IEICE Communications Society: [cs-secretariat@ieice.org](mailto:cs-secretariat@ieice.org)