

IEICE Communications Society GLOBAL NEWSLETTER Vol. 38, No.1 **Contents**

○ From CS Fellows

Cellular System Technologies and Handset Trends for High Capacity and Broadband Communications2
Atsushi Murase

○ IEICE-CS Related Conference Reports

Reports on EDAPS 2013 – Electrical Design of Advanced Packaging & Systems Symposium 20136
Hideki Asai

Report on 2013 International Symposium on Antennas and Propagation (ISAP2013)8
Hiroyoshi Yamada

Report on 15th Asia-Pacific Network Operations and Management Symposium (APNOMS2013)10
Yu Miyoshi, Makoto Takano

IEICE-CS Related Conferences Calendar11

○ From Foreign Students/Members

Research, Work and Life in Japan12
Cheng Zhang

Rediscovering Judo in Daily Life14
Christophe Michard

My New Starting Was from Japan16
Jing Gao

○ IEICE-CS Activities Now

Joint Conference on Satellite Communications (JC-SAT 2013) Report17
Fumihiko Yamashita, Satoshi Imata

Report on the 27th Optical Communication Systems Symposium
“Future of optical communication created by global strategy ~ scenario toward new stage ~”18
Technical Committee on Optical Communication Systems

ICSANE2013 – Collaboration with Space Community in AsiaPacific20
Masanobu Tsuji

Report on the 5th Workshop of Internet Architecture in Seoul, Korea22
Keisuke Ishibashi

○ IEICE-CS Information

Special Section Calendar of IEICE Transactions on Communications	23
CFPs for Special Sections on IEICE Transactions on Communications	24
IEICE Overseas Membership Page	28
IEICE Overseas Membership Application Form	29
IEICE-CS GLOBAL NEWSLETTER Submission Guideline	30
From Editor's Desk	32

○ Photogravure

IEICE General Conference in Niigata	Back cover
---	------------

***Color Version Available!**

*The PDF (color version) of this issue can be downloaded from IEICE-CS
Web site below:*

http://www.ieice.org/cs/pub/global_news.html

Cellular System Technologies and Handset Trends for High Capacity and Broadband Communications

Atsushi Murase (IEICE Fellow)

NTT Science and Core Technology Laboratory Group



1. Introduction

From analog voice service to broadband data communication service, cellular system technologies experienced a lot of evolutions, though the basic concepts of cellular capacity enhancement are not changed. On the other hand, cellular terminals have played very relevant role in each generation. Especially, Japanese 3G (the third generation) feature phones have got similar functions to current smartphones.

In this letter, I would like to describe cellular system technologies and handset trends for high capacity and broadband communications that I have experienced since I joined the field of mobile communication R&D in 1981.

2. Cellular Concepts and system technologies

The first generation (1G) of cellular systems with analog radio technologies commercially started in Japan in 1979 [1] and also in US and other countries in early 1980s. Figure 1 shows a basic cellular system in which a geographic service area is divided into smaller radio coverage areas called cells [2]. The frequency reuse between cells is the most basic concept in the cellular system and it is quite important the cell-splitting can support the capacity enhancement.

A mobile telephone communicates by radio signals with the base station in the cell site equivalent for a radio coverage area. The base station converts these radio signals for transfer to the switching center via wired links. The originating phone call by a mobile telephone is switched to another mobile telephone in the system or the appropriate landline facility [2].

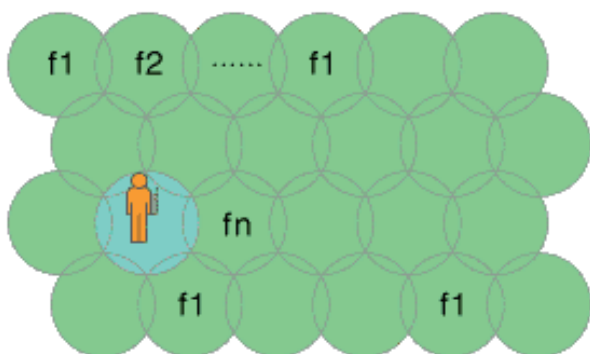

Fig. 1 Frequency reuse between cells.

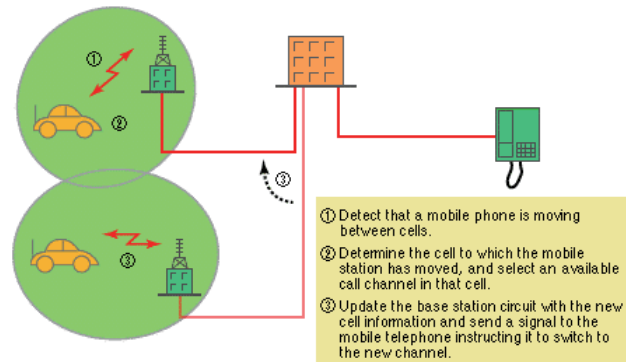

Fig. 2 Handover between cells.

Handover is also important concept and technology for cellular systems. Figure 2 shows the basic idea of switching channels during a phone call [2]. In addition, many technologies for achieving high capacity 1G system using FDMA (Frequency Division Multiple Access) are proposed by NTT such as carrier spacing minimization and high quality FM transceiver /receiver technologies [3].

Apart from voice radio channel capacity, radio control channel capacity was critical for 1G system. One big issue is realizing centrally controlled access channel scheme to handle many randomly accessing terminals. Idle-signal Casting Multiple Access (ICMA), which is a practical application of this centrally controlled system, has been utilized in the NTT's mobile phone system since December 1979. The ICMA-DR, which is an advanced ICMA scheme characterized by Data-slot Reservation, was proposed and implemented in the improved analog cellular

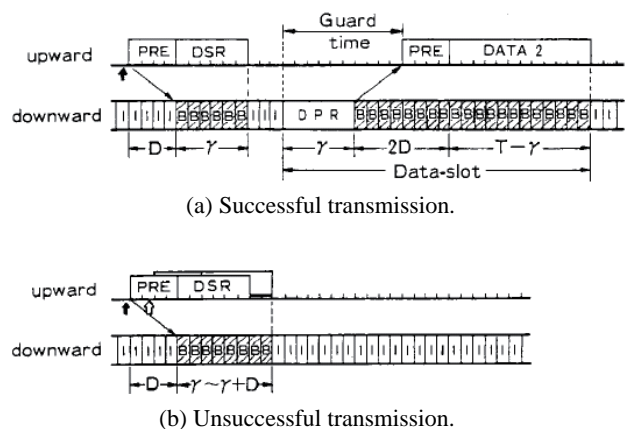

Fig. 3 ICMA-DR transmission.

system in 1988 [3]. Figure 3 shows ICMA-DR transmission scheme. It is found that ICMA-DR is suitable for a multiple access scheme in packet radio communication, especially under a mobile radio multipath fading environment [4]. At the same time, paging control channels scheme was also important for better paging performance and accurate location measurement [5].

3. Digital Cellular Systems Introduction with MAHO and Packet data Technology

NTT has started the commercial service of the digital cellular network in wide Tokyo area in March 1993. The digital cellular system (the second generation, 2G, system) using 3-ch TDMA (Time Division Multiple Access) has realized new services, lower system cost and spectrum economy. To cope with smaller cell-splitting in Tokyo metropolitan area, the performance of call connection process and call quality became higher by introducing new handover scheme i.e. MAHO (mobile assisted handoff). We also confirm the higher quality of the G3 fax transmission and MNP modem transmission in the digital cellular network compared to the quality in conventional analog cellular networks [6]. MAHO is one of basic technologies not only for 2G, but also 3G or later generation. And microcell-macrocell concept shown in Fig. 4 is already considered even in 2G systems [7].

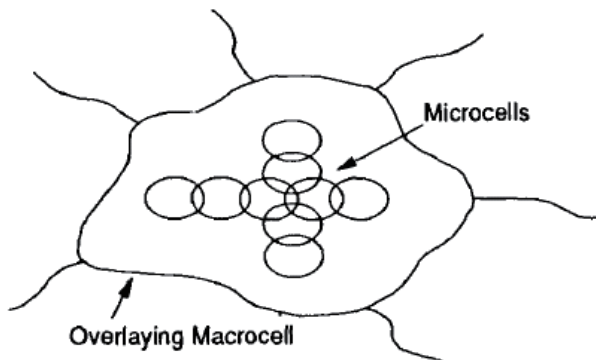

Fig. 4 Microcellular organization.

A PDC mobile Packet data communication system (PDC-P) is launched by NTT DoCoMo (now NTT DOCOMO) in 1997. PDC-P enables PDC users to send and receive packet data in the connectionless environment of multimedia mobile communications. Its main features are high throughput of user packet data, flexibility in response to service demands, and linkage with voice services. As a packet switched network on PDC, PDC-P facilitates various applications, which enable users to check their electronic mail, dispatch their jobs and access corporate databases or public information services. The PDC-P mainly supports TCP/IP protocol so as to interconnect with the Internet which are widely spread over the world and became a de facto standard of computer networks [8].

This PDC-P has been used for i-mode packet data platform and taken over in 3G FOMA i-mode packet

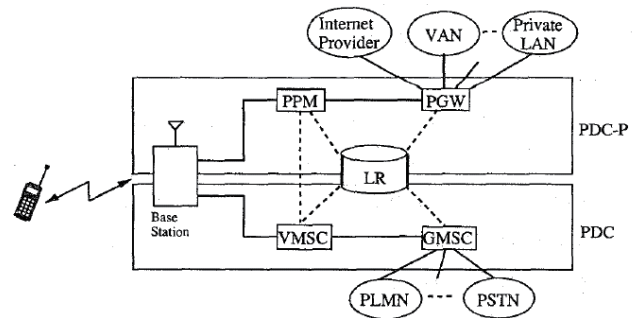

Fig. 5 PDC-P reference model.

data services later.

4. W-CDMA System and Terminals

In 2001, NTT DoCoMo started the FOMA service based on the 3rd generation (3G) mobile communication system with W-CDMA (Wide-band Code Division Multiple Access) technologies. The DoCoMo's W-CDMA network allowed us to have transmission speeds of 384 kbps. With the benefit of this broader bandwidth, mobile multimedia services are realized on top of the actual mobile network. Mobile visual phones and media streaming on demand were typical applications, as well as enhanced "i-mode" services that provide us with the ability to access Internet contents written in compact HTML [9].

3G FOMA terminals were wide in variety even in early 2000s, ranging from mobile-phone types, PC-card types dedicated to data communications, video-phone types that could display video, to Personal Digital Assistant (PDA) types that were combined with PDA. Whilst these variations could be categorized by the combination of their abilities, notable characteristics of 3G mobile terminals include the hardware multimedia capabilities, the ability to transmit over radio sections, and the ability to carry various types of multimedia applications. For example, Fig. 6 maps the terminals' ability to transmit over radio sections on the horizontal axis and their hardware multimedia capabilities (e.g. Display) on the vertical axis [10].

What makes the 3G terminals distinctive more than anything else is its high-speed transmission ability. However, there is a tradeoff between speed (which stresses the hardware such as memory and processing power) and size and portability. With W-CDMA, many mobile-phone types were expected to achieve speed up to 384 kbps, as it was easy to achieve 384 kbps packet transmission due to the fact that increased in downlink speed had a relatively small impact on hardware, thanks to wideband transmission. In environments where faster upstream transmission was required, variations like SOHO terminals were expected to appear: such as terminals connected with a server and multiple computers connected to each other in a Local Area Network (LAN) which are often used in the SOHO environment.

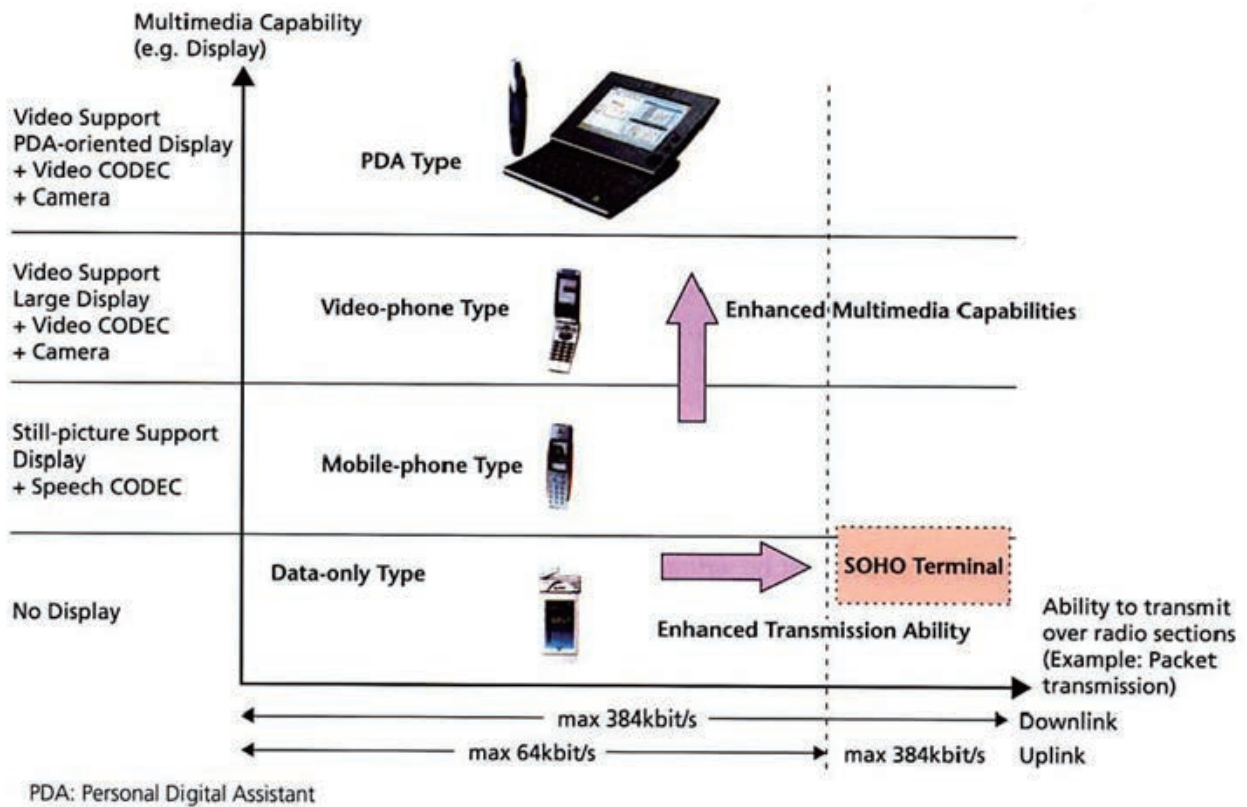

Fig. 6 Example of Correlation between Multimedia Capabilities and Radio Transmission Ability.

This variety of Japanese 3G feature phones have commercialized until 2002 and effected later FOMA or other 3G terminals. Even Smartphones emerged around 2010 took over many technical features of these FOMA terminals.

Figure 7 shows FOMA terminals and a UIM card that were released in 2001. The UIM card has been released in the first time in Japan at that time, and the diversity handover scheme that can maintain stable communication by simultaneously establishing connection with multiple base stations in cell boundary



Fig. 7 FOMA terminals and a UIM card for Introductory Services.

	N2001	P2101V	P2401
Size	Approx. 103×Approx. 52×Approx. 20 (mm)	Approx. 104×Approx. 56×Approx. 35 (mm)	Approx. 120×Approx. 56×Approx. 13 (mm)
Mass	Approx. 105 (g)	Approx. 152 (g)	Approx. 50 (g)
Display Performance	4096 colors, organic EL	260,000 colors, reflective TFT	—
Terminal Interface	USB	—	PCMCIA Type II
Speech Communications	○	○	—
Videophone	—	○	—
i-mode	○	○	—
M-stage Visual	—	○	—
SMS	○	—	—
64k Data Communications	○	—	○
Packet-switched Communications	Uplink 64kbit/s, Downlink 384kbit/s	—	Uplink 64kbit/s, Downlink 384kbit/s

EL: Electroluminescence
 PCMCIA: Personal Computer Memory Card International Association
 SMS: Short Message Service

TFT: Thin Film Transistor
 USB: Universal Serial Bus

Fig. 8 Basic Specifications of FOMA Terminals for Introductory Service.

regions has also been introduced [11]. Figure 8 shows basic specifications of FOMA terminals for introductory service.

5. Conclusion

Mobile phones and broadband services with cellular network systems have been quite popular and became a social basic infrastructure. From analog voice service to broadband data communication service, cellular system technologies experienced a lot of evolutions, though the basic concepts of cellular capacity enhancement are not changed. At the same time, cellular terminals have played very relevant role in each generation. Especially, Japanese 3G (the third generation) feature phones have got similar functions to current smartphones.

6. Acknowledgement

I wish to thank the R&D members of NTT and NTT DoCoMo for their contributions to this work during my life study in NTT and NTT DoCoMo Laboratories.

7. References

- [1] S. Ito and Y. Matsuzaka, "800 MHz Band Land Mobile Telephone System Overall View," IEEE Transactions on Vehicular Technology, vol.27, no. 4, pp.205-211, Nov. 1978.
- [2] Website:
<https://www.nttdocomo.co.jp/english/corporate/technology/rd/tech/bn/cellular/01/> and ~/04/
- [3] K. Watanabe and K. Imamura, "Evolution of NTT high-capacity land mobile communication system," IEEE International Conference on Communications, vol.1, pp.462-466, Jun. 1989.
- [4] A. Murase and K. Imamura, "Idle-Signal Casting Multiple Access with Data Slot Reservation (ICMA-DR) for Packet Radio Communications," IEEE Transactions on Vehicular Technology, vol.38, no.2, pp.50-54, May 1989.
- [5] K. Imamura and A. Murase, "Mobile Communication Control using Multi-transmitter Simul / Sequential Casting (MSSC)" Vehicular Technology Conference," vol.36, pp.334-341, May 1986.
- [6] M. Kuramoto, K. Kinoshita, A. Nakajima, T. Utano and A. Murase, "Overall system performance in a digital cellular system based on Japanese standard," Vehicular Technology Conference, pp.168-171, May 1993.
- [7] A. Murase, I.C. Symington and E. Green, "Handover criterion for macro and microcellular systems," Vehicular Technology Conference, pp. 524-530, May 1991.
- [8] A. Murase, A. Maehara, I. Okajima and S. Hirata, "Mobile radio packet data communications in a TDMA digital cellular system," Vehicular Technology Conference, vol.2, pp.1034-1038, May 1997.
- [9] K. Nagata and K. Irie, "Special Article on IMT-2000 Services (1) - Launch of FOMA, the Pioneer of the New Mobile Age – Service Overview," NTT DoCoMo Technical Journal, vol.3, no.2, pp.4-10, Sep. 2001.
- [10] K. Morita, K. Takagi, A. Murase, M. Murata and K. Sawai, "Special Article on IMT-2000 Services (1) - Launch of FOMA, the Pioneer of the New Mobile Age – Service and Terminals," NTT DoCoMo Technical Journal, vol.3, no.2, pp.11-17, Sep. 2001.
- [11] H. Takagi, K. Yunoki, Y. Okumura, S. Hagiwara, K. Anzawa and S. Abe, "Special Article on IMT-2000 Services (2) - Launch of FOMA, the Pioneer of the New Mobile Age – Mobile Terminal Technologies," NTT DoCoMo Technical Journal, vol.3, no.3, pp.41-48, Dec. 2001.

Reports on EDAPS 2013 – Electrical Design of Advanced Packaging & Systems Symposium 2013

Hideki Asai
Shizuoka University



1. Introduction

The IEEE Electrical Design of Advanced Packaging & Systems (EDAPS) symposium has been one of the most important events in Asia Pacific region for the researchers and developers related to the electrical design issues on chip, package and system levels. The EDAPS 2013 was held at Todai-ji Culture Center in Nara of Japan from December 12 to 14, 2013 (Fig.1) [1]. Additionally, a special joint workshop with EMC Compo2013 was embedded on Dec. 15th. The technical program of the symposium not only addresses the current technical issues but also brings out the challenges facing IC design, SiP/SoP packaging, EMI/EMC, and EDA tools and most importantly the challenge issues in advanced 3-D IC and packaging design. EDAPS 2013 was successfully terminated and this document reports the summary of this symposium.



Fig. 1 EDAPS 2013 held at Todai-ji Culture Center

2. Summary of EDAPS 2013

EDAPS 2013 consisted of seven keynote speeches, three special sessions, five oral sessions and two poster sessions. It was organized by Shizuoka University and technically co-sponsored by IEEE CPMT, IEEE CPMT Japan, IEICE CAS Society, IEICE Electronic Society, IEICE Technical Committee on Electromagnetic Compatibility and The Japan Institute of Electronics Packaging. The number of presented papers was 67 and the number of participants was 116 from 12 countries.

● Keynote Speeches

Seven keynote speeches were given by the researchers, two from academia and five from industry. The titles of keynote speeches were “3D/2.5D Packaging Technologies toward Scaling Challenge in the Era of Big Data,” “Where is 3D : Challenges in 2.5D/3D TSV integration,” “Power Noise Awareness in Design and Diagnosis of VLSI Systems,” “Challenges in EMC Analysis,” “Devices, Circuits, Packages and Systems,” “The Pathways to Cost-Effective Power/Signal Integrity Designs for High-Performance Mobile Systems,” and “Transition from 2D to 3D IC design: advantage, challenge and solutions”. All keynote speeches included cutting-edge topics and technologies and were very useful for participants.

● Special Sessions

The special sessions were organized by front-line researchers. Three sessions included 15 papers in the fields of advanced packaging, TSV, 3D IC/Package, signal/power integrity and EMC. They had large number of audiences and the discussions were very active (Fig.2).



Fig. 2 Presentation of Special Session

● Oral Sessions

The oral session was one of regular presentations of EDAPS. The summary of oral presentations is shown in Table 1. 17 presentations were from universities and 6 presentations were from industries. As shown here, the sessions cover the most important and up-to-date research fields in advanced packaging and systems and they have many excellent papers.

Table 1 Oral Presentations

No.	Session Title	Number of Presentations
1	3DIC / 3D-Stacked IC	4
2	Power Integrity / Ground Noise	5
3	Signal Integrity	5
4	EMC	4
5	Advanced Simulation Tools and CAD /RF Technology	5

● Poster Sessions

The poster sessions were very characteristic in EDAPS 2013 and 28 posters were presented during two days. The number of pages of paper is the same in the oral and the poster presentations and the difference is only the presentation style. Especially, the poster presentation is useful for students as an introduction to future oral presentation. The summary of poster presentations is shown in Table 2. The numbers of presentations from academia and industry were 21 and 7, respectively. The snapshot of poster presentations is shown in Fig.3. The poster presentations attracted many participants and they enjoyed the discussions with some snacks and beverages.

Table 2 Poster Presentations

No.	Field	Number of Presentations
1	3DIC / 3D-Stacked IC	4
2	Advanced Simulation Tools and CAD	3
3	Design and Modeling for High-speed Channels and Interconnects	2
4	EMC	5
5	Power Integrity / Ground Noise	6
6	RF/Microwave Package	2
7	Signal Integrity	5
8	Time/Frequency Domain Measurement Techniques	1

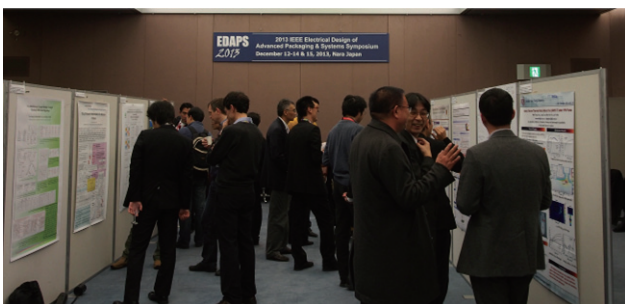

Fig. 3 Snapshot of Poster Presentations

For the presented papers, please visit the IEEE Xplore digital library [2].

● Awards

Three kinds of awards were given to the corresponding paper and presentations,

particularly, encouraging the students. They are “Best Paper Award,” “Best Student Award for Oral Presentation,” and “Best Student Award for Poster Presentation” based on the strict reviews by some researchers. The awards are given to the authors and the presenters in USA and Malaysia, Taiwan and Japan as shown in Table 3.

Table 3 Awards

No.	Award	Winner
Best Paper		
1	Comparing Fast Convolution and Model Order Reduction Methods for S-Parameter Simulation	José E. Schutt-Ainé, University of Illinois, USA and Patrick Goh, Universiti Sains Malaysia, Malaysia
Best Student Award for Oral Presentation		
2	Ferroelectric Thin-Film Integrated Capacitor and Its Application in Radio-Frequency Phase Shifter Design	Hsiao-Yun Li, National Central University, Taiwan
Best Student Award for Poster Presentation		
3	Effect of EBG Structure and Ferrite Film on Power/ground Layers for Performance Maintenance and Noise Suppression in Wireless Communication	Kenta Ishimura, Okayama University, Japan

● Participants at the Venue

EDAPS 2013 was successfully terminated with more paper submissions and more participants than expected. Many participants were satisfied with EDAPS 2013. The snapshot of all participants of the final day is shown in Fig.4.



Fig. 4 Participants on the Final Day

3. Conclusions

EDAPS 2013 was successfully terminated and the organizing committee members appreciate for the technical co-sponsors. Next EDAPS will be held in Bangalore, India, from Dec. 7 to 9, 2014.

4. Reference

- [1] EDAPS 2013, <http://edaps2013.dept.eng.gunma-u.ac.jp/index.php>.
- [2] IEEE Xplore digital library, <http://ieeexplore.ieee.org/Xplore/guesthome.jsp> (to appear).

Report on 2013 International Symposium on Antennas and Propagation (ISAP2013)

Hiroyoshi Yamada
Niigata University, ISAP JSC Secretariat

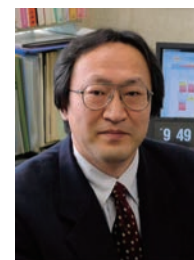

1. ISAP2013

2013 International Symposium on Antennas and Propagation (ISAP2013) was held at Jiangning Exhibition Center, Nanjing, China from October 22 to 25. This was the seventh ISAP outside Japan and the first ISAP in main-land China since the symposium started to be held in Asia-Pacific region every year. The organizer was Southeast University. This symposium was co-sponsored by University of Electronic Science & Technology of China, and technically co-sponsored by 9 academic organizations and companies including the IEICE Communications Society.

As General Co-chairs, Prof. Wei Hong (Southeast Uni.), Prof. Le-Wei Li (Univ. of Electronic Sci. & Tech. of China), and Prof. Shu-Xi Gong (STAML), and as Technical Program Committee (TPC) Co-chairs, Prof. Xiao-Wei Zhu (Southeast Univ.), Dong-Lin Su (Beijing Univ. of Aeronautics and Astronautics), Yi-Jun Feng (Nanjing Univ.), and Zhi-Peng Zhou (STAML), served.

The size of the symposium reached the top level of former ISAP symposia as shown in Table 1. Papers were submitted from 27 countries/regions not only in Asia-Pacific but all over the world. Table 2 shows the ranking countries/regions with accepted papers number of three or more. Approximately 100 reviewers nominated by international review system contributed energetically multiple-review work in a limited time and supported TPC.

After two half-day workshops on October 22, opening ceremony, and three keynote speeches, 36 technical oral sessions including 11 special sessions, and 6 poster sessions were presented in three days from October 23 to 25. One of the poster sessions was the student paper contest. Figure 1 is the photo of welcome address from Prof. Wei Hong, General co-chair, at the opening ceremony.

The keynote speeches were as follows,

- Dr. Shinichi Nomoto (KDDI, Japan), “A teleco’s view for better customer expectations in multi-band, multi-device and multi-demand smart society”
- Prof. Kin-Lu Wonf (Nat’l Sun Yat-sen Univ., Taiwan), “4G/Multiband hand device antennas and their antenna systems”
- Prof. Per-Simon Kildal (Chalmers Univ. of Tech., Sweden), “Rethinking the wireless channel for OTA testing and network optimization by including user statistics: RIMP, pure-LOS, throughput and detection probability”

Table 1 Major statistics

Papers submitted	Papers Accepted	Registers /Attendees
420	359	356/368

Table 2 Number of accepted papers

China	232
Japan	39
South Korea	16
Taiwan	15
Malaysia	7
Singapore	6
Sweden	6
United Kingdom	4
Iran	3

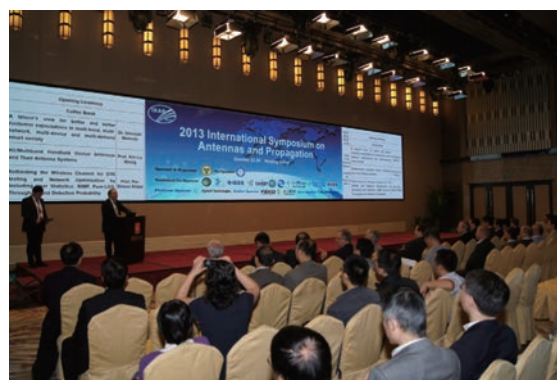

Fig. 1 Opening ceremony

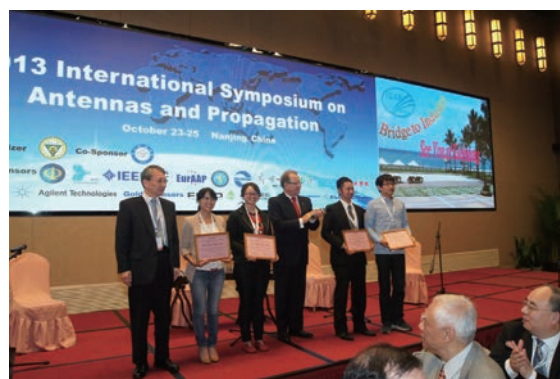

Fig. 2 Winners of the Student Paper Contest

Student paper contest was also held at the symposium. Fifteen candidates among 140 applicants were selected by the TPC as the finalists, and four of them shown in Fig. 2 were awarded as the winners at the banquet on October 24.

2. ISAP International Steering Committee meeting

The first ISAP was held at Sendai, Japan in 1971, and nine symposia were held in Japan. In 2001, ISAP Japan Standing Committee (JSC) was organized in Communications Society of IEICE. The JSC started to sound possibilities of holding ISAP outside Japan and negotiate with several foreign leaders in potential countries. The first ISAP outside Japan was held in Korea in 2005.

In order to hold ISAP continuously and smoothly, we established ISAP International Steering Committee (ISC) during ISAP 2006 with 9 countries/regions. Now the number has reached 12, Australia, China, Hong Kong, India, Japan, Korea, Macao, Malaysia, Singapore, Taiwan, Thailand, and new member, Indonesia. The mission of the committee is planning future ISAP and establishing operation rules to steer the symposia smoothly using international cooperation.

In the period of ISAP2013, ISC regular meeting was held. Members are shown in Fig. 3. The operation of the symposium was discussed and future ISAP venue has been decided in the meeting.

ISAP-ISC has decided that the venue of ISAP2016 will be Okinawa, Japan in this meeting. Thus the venues up to 2016 have been decided, Kaohsiung, Taiwan in 2014, and Tasmania, Australia in 2015.

3. ISAP Archives

ISAP ISC also set up ISAP Archives recording all papers presented at the previous ISAP. At this moment all papers from the first ISAP in 1971 to ISAP 2012 have been digitized and online, as a result everybody in the world AP community can access ISAP papers with free of charge. This service will respond to expectations of AP specialists in the world and enhance motivations for Asian people to submit papers.

The URL of the ISAP Archives is “<http://ap-s.ei.tuat.ac.jp/isapx/>” and the top page is shown in Fig. 4. The contents of ISAPs held in Japan can also be reached through IEICE’s I-Scover (<http://i-scover.ieice.org/>). The papers of ISAP2013 will appear in ISAP archives in May 2014. In addition to the ISAP archives, papers of recent ISAPs have been also included in IEEE Xplore.

4. Conclusion

ISAP 2013 provided to contributors and participants an academic and friendship atmosphere for exchanging advances in AP research and strengthening relationship. Many young students also had a chance to discuss with the experts in their fields. The upcoming ISAP 2014 will be held in Kaohsiung, Taiwan, from December 2 to 5, 2014. Deadline for paper submission is July 4, 2014. Please see the details in the ISAP 2014 Web site shown in Fig.5 (<http://isap2014.org/>).



Fig. 3 ISAP ISC meeting on Oct. 23.



Fig. 4 Top page of ISAP Archives



Fig. 5 ISAP2014 Web site (<http://isap2014.org/>)

Report on 15th Asia-Pacific Network Operations and Management Symposium (APNOMS2013)

Yu Miyoshi*, Makoto Takano**

*Secretary of the conference, NTT Corporation

**General Chair of the conference, NTT-AT Corporation.



1. Overview of APNOMS 2013

The 15th Asia-Pacific Network Operations and Management Symposium was held from September 25th to 27th, 2013 in Hiroshima [1]. APNOMS 2013 was organized by the IEICE ICM Committee and the Korean Information and Communications Society, Korea Network Operations and Management Committee (KICS KNOM). It was technically co-sponsored by IEEE Comsoc. Supporting organizations were IEEE CNOM, IEEE APB, TMF, IEEE Cloud Computing.

APNOMS 2013 entitled “Integrated Management of Network Virtualization” consists of five keynote speeches, one DEP session, two special sessions, four tutorial sessions, nine technical sessions, three poster sessions, three innovation sessions and the exhibition program. 207 people from 9 countries participated in this conference.

2. Sessions and Activities

Five executives delivered keynote speeches. Mr. Yasuyoshi Katayama, Senior executive vice president from NTT gave a speech on “Trends in Telecommunications Services in Japan” (Fig.1). Mr. Nik Willetts, Chief strategy officer of TMF, introduced a new vision named “Open Digital Economy”. Dr. Yuan-Kuang Tu from Chunghwa Telecom showed expectations to SDN and NFV from telecom operator’s perspective. Dr. Doug Zuckerman introduced the activities of Cloud Computing Initiative in IEEE. Dr. James W. Hong from Korea Telecom proposed the “Video Traffic Bandwidth Optimization” on wireless networks for smart devices.

In the Distinguished Experts Panel session, a chair and four panelists, including Prof. Akihiro Nakao from the University of Tokyo, discussed various topics with the audience in relation to the theme of APNOMS 2013, for example, management issues for network virtualization (Fig.2).

In the tutorial sessions, the practical measurement methodologies were presented by Dr. Masafumi Watari from KDDI Laboratories and the StarBED network testbed was introduced by Dr. Razvan Beuran from NICT. Dr. Kohei Shiomoto from NTT and Prof. Nakao were the Japanese speakers in special sessions.

A total of 103 papers, including 29 papers from Japan, were submitted to APNOMS 2013 and of these 36 were presented in nine technical sessions. It includes 13 papers from Japan. In the poster session, 49 papers



Fig. 1 Keynote Speech by Mr. Yasuyoshi Katayama



Fig. 2 Distinguished Experts Panel

including 13 Japanese papers were delivered as poster-style presentations. These papers were published in IEICE I-Scover and IEEE Xplore. There were three innovation sessions that covered 14 topics. We have 9 topics from Japan. In the exhibition program, three organizations demonstrated four prototypes of their research results. As a social event, a banquet was held that included a “Traditional Kagura-Mai (Sinto dance)”.

Lastly, the APNOMS 2013 organizing committee selected the top three papers with the highest overall (paper + presentation) scores from the technical session for “Best Paper Awards”. One of awardees is Mr. Naoki Tateishi from NTT, who presented “Method for visualizing information from large-scale carrier networks” and the others are a Korean and a Taiwanese student.

3. Conclusion

On behalf of all OC members of APNOMS 2013, we would like to express our appreciations to all parties involved in this conference.

The next APNOMS will be held in Hsinchu, Taiwan, in September 2014.

4. Reference

[1] <http://www.apnoms.org/>, Home page of APNOMS.

IEICE-CS Related Conferences Calendar

Date	Conference Name	Location	Note
2 Dec - 5 Dec 2014	2014 International Symposium on Antennas and Propagation (ISAP2014)	Kaohsiung, Taiwan	Submission deadline: 4 Jul. 2014
1 Oct. - 3 Oct. 2014	The 20 th Asia-Pacific Conference on Communications (APCC 2014)	Pattaya, Thailand	Submission deadline: 1 Jul. 2014
6 Jul. - 10 Jul. 2014	OptoElectronics and Communications Conference and the Australian Conference on Optical Fibre Technology 2014 (OECC/ACOFT 2014)	Melbourne, Australia	Submission deadline: Closed
1 Jun. - 3 Jun. 2014	World Telecommunications Congress 2014 (WTC 2014)	Berlin, Germany	Submission deadline: Closed
28 May - 30 May 2014	2014 IEICE Information and Communication Technology Forum (IEICE ICTF 2014)	Poznan, Poland	To be held soon
13 May - 16 May 2014	2014 International Symposium on Electromagnetic Compatibility (EMC'14/Tokyo)	Tokyo, Japan	To be held soon
10 Feb. – 12 Feb. 2014	The 28 th International Conference on Information Networking (ICOIN2014)	Phuket, Thailand	Done
12 Dec. - 15 Dec. 2013	2013 IEEE Electrical Design of Advanced Packaging & Systems (EDAPS2013)	Nara, Japan	Reported on this issue
23 Oct. - 25 Oct. 2013	2013 International Symposium on Antennas and Propagation (ISAP2013)	Nanjing, China	Reported on this issue
23 Oct. 2013	International Workshop on Cloud Cooperated Heterogeneous Networks (CC-HetNet2013)	Osaka, Japan	Done
20 Oct. - 23 Oct. 2013	International Conference on Renewable Energy Research and Applications (ICRERA 2013)	Madrid, Spain	Done
14 Oct. - 17 Oct. 2013	17 th International Conference on Intelligence in Next Generation Networks (ICIN2013)	Venice, Italy	Done
14 Oct. - 16 Oct. 2013	International Conference on Information and Communication technology Convergence 2013 (ICTC2013)	Jeju Island, Korea	Done
30 Sep. 2013	TeleManagement Forum Tokyo Spotlight 2013 (TM Forum Tokyo Spotlight 2013)	Tokyo, Japan	Done
25 Sep. - 27 Sep. 2013	Asia-Pacific Network Operations and Management Symposium 2013 (APNOMS 2013)	Hiroshima, Japan	Reported on this issue

Please confirm with the following IEICE-CS web site for the latest information.

<http://www.ieice.org/cs/conf/calendar.html>

Research, Work and Life in Japan

Cheng ZHANG

Global Information and Telecommunication Institute
Waseda University

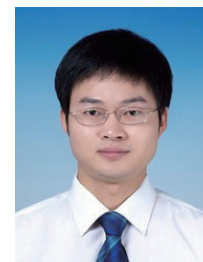

1. Introduction

First of all, I would like to thank the editors of IEICE-CS GLOBAL NEWSLETTER for giving me this opportunity to share my personal experience in Japan.

I was born in Hubei province, China. I received my B.E. degree in Industry Automation from Wuhan University of Science and Technology in 2005, and I obtained my M.E. degree in Control Theory and Control Engineering from Shanghai JiaoTong University in 2008. I came to Japan as an engineer in Sony Digital Network Applications, Inc., in 2008. And then I began to pursue my PhD degree at Waseda University in 2010. From 2013, I become an invited researcher at Global Information and Telecommunication Institute, Waseda University. Time is flying, I have been in Japan for more than five years. I am really happy to share my 5-year experience in research, work and life aspects.

2. Research in Japan

I am doing my research in Tanaka laboratory, Waseda University. My research topic is network economics, which is an interdisciplinary of telecommunication network and economic theory. I initially encountered with many difficulties since I did not have any economic background before I started my doctoral course study. However, I could overcome the difficulties under the guidance of Professor Tanaka.

Firstly, there is weekly seminar in our laboratory. During the seminar, I present my research and I can get many useful advices from Professor Tanaka as well other teachers and students, who maybe in a different research area. The discussion always is quite interesting. There is also a joint summer seminar among Waseda University, Shibaura Institute of Technology, and National Institute of Informatics. I can discuss my research with many more teachers and students there.

Secondly, there is a research meeting in the weekend once a month. The focus of this research meeting is network economic, which is rather new research area in Japan. We can concentrate on a specific topic and discuss much more deeply. There is also expert in network economics outside of Waseda University, like associate Professor Kamiyama from Osaka University, taking part in this research meeting.

Thirdly, there are many chances I can communicate with researchers outside of Waseda University by taking part in international conference and domestic

conferences. For example, I have taken part in Asia-Pacific Network Operations and Management Symposium (APNOMS) in 2013, and I take part in IEICE General Conference and IEICE Communication Society Conference each year since 2010. I really learned a lot through discussion with researchers at the symposium/conferences.



Fig. 1 IEICE General Conference at Gifu University, in 2013.

Fortunately, I received the IEICE Young Researcher's Award for my two papers published in 2012 IEICE General Conference and in 2012 IEICE Communication Society Conference [1][2]. One of the awarded paper has been extended and published in IEICE Transactions on Communications [3].

Here I would like to thank Professor Yoshiaki Tanaka, my advisor associate Professor Kyoko Yamori, Dr. Sugang Xu, and assistant Professor Bo Gu. I really enjoy discussing research with them. I would not have been proceeded so smoothly without their guidance, support and collaboration.

3. Work in Japan

Actually, I have been fascinated by Japanese precision instrument of high quality before I came to Japan. I fortunately have a chance to work in one of Japanese top manufacturers of consumer electronics, where I have done research and development for one kind of precision instrument, digital camera.

I was responsible for image stabilization module of digital camera. I marveled at the complexity of the module initially. To develop an image stabilization module is not an easy work. The difficulties are as the follows.

Firstly, a good algorithm (digital filter) should be well designed. There is no well-done algorithm. I could not refer to any text book. I have to try once again and

again with different algorithms, to verify the performance of different algorithms.

Secondly, the values of more than one thousand parameters have to be properly tuned. The performance of image stabilization module heavily depends on the proper values of the parameters. Without proper parameter values, the best algorithm may be failed.

The above difficulties are successfully overcome by me and my colleagues through team work and many kinds of experiments. The performance of image stabilization function is improved a lot and is ultimately approved by customers all over the world. Through the process of working with my Japanese colleagues, I have found the smartness and diligence of Japanese. As far as I am concerned, it is the team work spirit of Japanese make Japanese precision instrument successful.

4. Life in Japan

Thanks to many long holidays, I have many chances to enjoy my life in Japan. The transportation system is well developed in Japan. It is very convenient to take Shinkansen for travelling. I have travelled a lot of places in Japan such as Osaka, Atami, Hokkaido, Okayama, Toyama, Fukuoka, Hiroshima, Hakone, Izu, and so on. I am impressed by the beautiful scenery in many places. My favorite thing in travel is to drive a car by myself and enjoy the scenery along the road, such as forest with tall trees, or sea.



Fig. 2 Itsukushima Shrine, World Heritage of Hiroshima.

I like Japanese food very much, especially the Japanese sea food. I have never eaten uncooked food before I came to Japan, but I gradually get used to Japanese Nama food, such as Sashimi.

There are many kinds of drink parties in Japan. Whenever there are something happened, a drink party will be held. For example there are New Year party, year forgetting party, and so on. One characteristic of Japanese drink party is that there may be more than one round. The second round, even third round drink party may be held in a different restaurant. I am not strong in drinking, but I enjoy the atmosphere of a drink party since I can communicate with other gays in the party freely.



Fig. 3 Japanese cherry blossoms in Izu.



Fig. 4 Japanese Sashimi in drink party.

5. Conclusion

I do not realized that I have experienced so much in Japan until I am about to finish this article. Writing this article has been a good opportunity for me to look back my life in Japan. I think life is a long journey, and my experience in Japan has been an importance part of my life journey.

Finally, I would like to thank again the IEICE for giving me this chance to publish my article. I hope my personal experience can give some hints to people who want to do research and work in Japan.

6. Reference

- [1] C. Zhang, K. Yamori, S. Xu, and Y. Tanaka, "Forward Contract to Solve Demand and Revenue Uncertainty Problem in Network Congestion Management", 2012 IEICE General Conference, No.BS-3-8, pp.S-15-S-16, March 2012.
- [2] C. Zhang, K. Yamori, S. Xu, and Y. Tanaka, "Time-Dependent Pricing for Revenue Maximization", 2012 IEICE Communications Society Conference, No.BS-5-3, pp.S-32-S33, September 2012.
- [3] C. Zhang, B. Gu, K. Yamori, S. Xu, and Y. Tanaka, "Duopoly Competition in Time-Dependent Pricing for Improving Revenue of Network Service Providers", IEICE Transactions on Communications, Vol.E96-B, No.12, pp.2964-2975, December 2013.

Rediscovering Judo in Daily Life

Christophe Michard
Osaka Prefecture University



1. Introduction

First of all, I would like to thank the editor of IEICE-CS GLOBAL NEWSLETTER for giving me this opportunity to develop a subject important to me, and directly connected to the Japanese culture, the Judo.

My name is Christophe Michard, from France. I have come in Japan for studies for more than four years now. I am currently finishing my PhD course at Osaka Prefecture University, Graduate School of Engineering, Department of Computer Science and Intelligent Systems. The subject of my thesis, conducted by Professor Hideki Tode, is the development of a new kind of optical network.

I develop in this article how my conception of judo has changed since I live in Japan, and how I have linked it to my piano practice as a principle, a way of thinking, more than a simple physical activity.

2. How my conception of Judo has changed

I practiced judo in France from four to ten years old. After that, I practiced other martial arts, like taekwondo or Brazilian jiu-jitsu. I learned a lot from my different instructors, and will always be grateful for their guidance. When I came in Japan, in September 2009, I decided to go back to my source, the judo, and have been a member of the judo club of Osaka Prefecture University since November 6, 2009. The following day, I met the instructor of the club, Makoto Takatsu, which is an instructor of the Kodokan of Osaka, and also teaches judo to the riot police.

Martial arts, as well as other activities, need direct experience to be understood. And what I mean is direct contact. Judging a practice without directly experiencing it is usually a proof of inexperience. A practice might look harsh or clumsy from an external point of view, but in reality be incredibly soft and precise when you personally feel it. In every discipline, masters have internalized and simplified their movements in such a way that they cannot be seen with the eyes. In particular, this is true in old martial arts, where practitioners had to rely on techniques to save their lives. They had to change the way they were using their body in order to develop invisible movements [1].

During practice, I have always relied on my sensations—which can be likened to intention reading—in order to know when my training partner would attempt a technique, rather than physical reflexes. This allowed me to deal with practitioners who rely on pure force and physical abilities. Moreover, before coming in Japan, I always believed that since physical abilities of a human body would eventually

decline with the age, relying on technique is not an option. Nevertheless, I never experienced at this time the kind of technique I am now discussing. I received the technique of competent artists, but not enough to say myself “this is what I am looking for”. Since I joined the judo club of the university, I had four times such an experience.

The first one happened one week after joining the club. A former member of the club, Mr. Ako, came for practice. At the time he held a fifth dan, and his young years were behind him. Additionally, he is way smaller and lighter than me. I had the pleasure to practice with him during a randori session. This is when it happened. The foot sweeping technique of Mr. Ako was really skillful. I have always had a good balance but I was thrown so easily that it was ridiculous. Even when I was not moving at all, trying to figure out how he did his moves by relaxing my body and focusing on my balance, at the instant Mr. Ako moved, I was instantly flying in the air without understanding what happened. This day, after the club activities, I was really moved. I finally felt the sensation I was looking for, the kind of sensation that cannot be learned in books or videos, but only by direct transmission. The second one happened about two years later, when Takatsu sensei showed me his *o uchi gari* (large inner reap). At the moment he grabbed my jacket (*kumikata*), I felt a completely new sensation. It was like he instantly took control of me, and I *inexorably had to take the fall*. Inexorability may be the mark of masters. This is completely different from what one could call Olympic judo. No need for a grip battle or crush your opponent with force. At the instant he put his hands on me it was over. The final ones occurred when Takatsu sensei answered my questions concerning the *nage no kata* and the *ju no kata*. As for *o uchi gari*, the instant of contact revealed his mastership.

The physical abilities of a human body eventually decline—this cannot be avoided. But now I can understand that there is a physical state, a way of using our body, which is independent of our physical fitness. There is a dimension of practice where physical qualities are not relevant, a dimension where we can always progress. My conception of judo and martial arts in general has been profoundly changed.

3. Rediscovering my piano practice

During the past four years, I have studied more deeply why Kano Jigoro created the judo and what his objectives were. Living in Japan, it was easy for me to find original resources [2]. I have also enlarged my

vision to other arts or practices where a different usage of the body is stressed. For instance, I find the points of view of Yoshinori Kono, Tetsuzan Kuroda and Akira Hino worth to be studied. I could discuss the vision of judo Jigoro Kano had, how it is a principle more than a discipline that can be used in daily life, how the physical aspect of the practice is only a support to understand the principle, but I will not. First, I would like to develop how one of the judo mottos, *seiryoku zenyō* (good use of energy; maximum efficiency with minimum effort), can be used in order to improve our proficiency in another practice. Then, I would like to present my personal experience concerning the usage of the body in another activity.

In parallel of martial arts, I also studied the piano at the music academy, and bought an electronic piano as soon as I came in Japan in order to be able to continue my practice. I still remember the instructions of my piano teacher, Christophe Vautier. I still remember how he wanted me to learn a new piece, how to analyze the structure of the composition to make the learn curve incredibly fast. At that time, I did not understand the reasons why my professor wanted me to practice a certain way, why he put a lot of effort into fixing my posture and fighting any stiffness of my body. I finally came to intellectually understand the reasons of the efficiency of both a good analysis and a correct use of the body thanks to my judo practice.

To make it short, the analysis and associated exercises allow to optimize the time of practice. Chuan C. Chang [3] made a remarkable job, compiling good practices and explaining why they are efficient. For instance, a most important learning trick is to adequately choose a short practice segment, for several reasons. 1) Within a difficult passage of say, 10 bars, there are typically only a few note combinations that stymie you. There is no need to practice anything other than those notes. 2) Practicing short segments allows you to practice it dozens, even hundreds of times, in a matter of minutes. 3) The shorter a segment you choose, the faster you can practice it without ill effects. This example is directly related to *seiryoku zenyō*, the good use of energy. Instead of wasting time on segments you already know by playing the entire piece as the unique way of practice, you can instead reduce your effort to less than a dozen of notes at a time. If the chosen segment is short, you can practice most of the time at or beyond final speed, which is the ideal situation because it saves so much time, maximizing the efficiency. In judo, the same methodology exists, called *uchi komi*. Techniques are isolated and practiced repeatedly in short cycles. Randori practice can be considered as the composition of the piece itself.

The correct use of the body is also critical. Relaxation (involving the whole body), arm weight (gravity drop), and avoidance of mindless repetitive exercises were key elements in Chopin's teachings [4]. Chopin insisted on musical playing before acquiring technique because he knew that relaxation, music and technique are inseparable. Relaxing means that you use

only those muscles that are needed to play. The human brain can be quite wasteful. For even the simplest tasks, the untrained brain uses most of the muscles in the body. And if the task is difficult, the brain tends to lock the entire body in a mass of tensed muscles. In order to relax, you must make a conscious effort to shut down all unnecessary muscles. This is not easy because it goes against the natural tendencies of the brain. Relaxing does not mean to “let go of all muscles”; it means that the unnecessary ones are relaxed even when the necessary ones are working full tilt, which is a coordination skill that requires a lot of practice. In judo, it can be compared to stiff arms. Beginners tend to stiff their arms as a natural defense. On the opposite, confirmed artists can instantly take control of you and gently place you on the ground by staying completely relaxed. The master accepts your technique and calms it down to a zero energy level and there is nothing you can do. As far as I can understand, arms should act like ropes, and shoulders should be relaxed. Similarly to the piano, muscles of the back are important: larger muscles of the body allow finer control. In piano, the entire body plays, not the fingers. In judo, the entire body movement and the connection with the partner produces the most beautiful techniques; not lifting the body of your partner using physical strength—arms in particular. I have been able to establish a connection between how I use my body efficiently during both my piano and judo practices. The one trains the other, and vice versa. When I came to realize that, every piano session—even short ones—was physically exhausting. Muscles of my back were quickly tired due to short movements. But it quickly paid back. My skill was considerably improved, and stress in my hands disappeared. My piano teacher was right.

The same way, I was able to link my judo skills to other activities, like swimming, social dance or Japanese calligraphy. My daily life has also been modified after thinking about how to move more efficiently, *i.e.* perform simple gestures with less effort.

4. Conclusion

Coming in Japan and experiencing the judo of skilled people allowed me to reconsider all my activities and how to apprehend new ones through a simple principle. As aforementioned, Judo is not limited to a physical activity. Jigoro Kano was mainly focused on how Judo, as a principle, can be used to improve the society by developing the individuals physically, intellectually and morally. Give it a try!

5. References

- [1] 「黒田鉄山 士の原理」, 『月刊秘伝』2014年2月号, BAB ジャパン社.
- [2] 嘉納治五郎 (1992) 『嘉納治五郎著作集』(全三巻) 五月書房.
- [3] Chuan C. Chang, “Fundamentals of Piano Practice,” 2009.
- [4] Jean-Jacques Eigeldinger, “Chopin: Pianist and Teacher: As Seen by his Pupils,” Cambridge University Press, 1988.

My New Starting Was from Japan

Jing Gao

Information System, Engineering Faculty, Niigata University



1. Introduction

It is pleasure to share with you about my experiences of study and research life in Japan. Thank IEICE-CS and it's editors for provide the excellent medium.

In the last three years, I studied on wireless network with JSPS-Grant-24246068 leader, Professor Kenichi Mase in Niigata University. In earlier time, I studied at Ryukyu University, and received my B.Sc., M.Sc. and Eng. Doctoral degree. In Japan, there are many worthy stories and sentiments. These experiences will become precious treasure which makes me grow up.

2. Transfer to Ryukyu University

My new start was from a Japanese course student at Okinawa University in 1999. Before this, I had studied on electronic application technology for three years at Tsinghua University in china. In 2000, I passed the exam for admission to enter the 3rd grade of engineering faculty of Ryukyu University. The 1st year in Ryukyu Univ. was hard for me due to my poor Japanese and incorrect study method. As well known, the electric and electronic engineering class requires one experiment report every two weeks. I was so slow to complete the 10-page report that which couldn't be submitted on time. My advisor, Prof. Tomonobu Senjyu arranged a master student to help me, and told me: "The report has to be submitted before deadline. Your life has a similar deadline, too!" Until today, I think his advisory word is so honest and no lack of good faith. My master study was in optical fiber transmission characteristics with Prof. Yoshinori Namihira. I mainly studied on fiber's wavelength dispersion and nonlinearity.

In 2005, I advanced to doctoral cause and changed my direction to wireless communication. It was a difficult decision to pursue a doctoral degree because I had a nice job chance then. My supervisor was Prof. Tomohisa Wada who often kindly smiles at everyone. He told me: "This is a severe field, and so many researchers are working in which. Your big effort maybe is the only one way." I can remember his often-question: "What is new?" The ISDB-TV receiver of Japan digital broadcast standard was selected as my issue relate to OFDM and multi-antenna technology.

3. My post doctoral research in Niigata University

At first, I wish to thank the IEICE Fellow, Prof. K. Mase. He has retired but keeps his research activity as University Fellow. Under his inspiration, this article was written. In honest, I didn't have any network knowledge before. In Mase team, I has been advanced and guidance in the new field.



(a) Sakura in Niigata Univ. (b) WLAN experiment
Fig. 1 Please watch our campus and our work



Fig. 2 Author and Prof. MASE (right) in the 17th IEEE ISADS

Mase Lab. was a large team when I joined it in 2011. They had worked on wireless networks research for more than decade. A large scale testbed had been built, which is composed of near 80-outdoor-node in Niigata Univ. campus and more than 10 nodes located far away campus area. It is one of the few testbed in the world scope. By using it, the pragmatic technique conclusions can be yielded and ensured. Through IEEE and IEICE library, the papers contributed by Mase Lab. have been viewed or cited as suggestions or documents for many times. It provides a good research platform for who are interesting in ad hoc, sensor and mesh networking.

My research has been focused on experiment investigation of WLAN performances in real field, including the cases based on UAV system (balloon, helicopter). All these are envisaged for emergencies data delivering in disaster recovery. In the past 2013, a new networking architecture based on the electric vehicles (EV) incorporating with unmanned mini electric helicopters (EH) has been studied by us.

As my future study, cross layer design will be marked.

4. Acknowledgement

Author had been supported by scholarships provided by JASSO, HEIWA NAKAJIMA, Lions Clubs Okinawa and Ryukyu University Alumni Association.

Joint Conference on Satellite Communications (JC-SAT 2013) Report



Fumihiro Yamashita, Nippon Telegraph and Telephone Corporation
Satoshi Imata, KDDI R&D Laboratories

1. Introduction

The Joint Conference on Satellite Communications 2013 (JC-SAT 2013) was held on 24th and 25th of October 2013 at the IP CITY HOTEL in Fukuoka. The conference has been annually held with jointly organized by Technical Committee on Satellite Communications of IEICE (IEICE SAT) and Korea Society of Space Technology (KOSST) since 2000. It aims at information exchange and enhancing mutual understanding between satellite communication researchers and engineers of both Japan and Korea.

2. Program

The session started with opening speeches by the organizing committee chairs, Prof. Masazumi Ueba, chair of IEICE SAT (Fig. 1). The number of submitted papers is 29 including 2 keynote speeches, and that of participants are about 50. The technical session titles are as follows:

- Current Status and Future Plans
- Satellite Communication Systems and Applications
- Satellite System Technologies
- Disaster Recovery Operations
- Satellite Communication Technologies
- Antenna Technologies and Propagation Analysis

3. Best Paper Awards

The best paper awards of JC-SAT were granted to the distinguished papers selected each from Japan and Korea. One was “Experimental evaluation of Distributed Array Antenna controller for ESV employing 3 antennas” by Kouhei Suzuki (Fig. 2), Takashi Hirose and Takatoshi Sugiyama, and the other was “Development of GNSS Position Accuracy Simulation System (GPASS) Using 3-D Building Maps, Signal Propagation Model and Receiver Correlator Model” by Yang-Won Lee and Ryosuke Shibasaki. A set of certificate was handed to each representative of the authors in the JC-SAT award ceremony.

4. Conclusion

A closing session was held in the end of day-2 with presentations of Dr. Kashiki, who is the vice chair of IEICE SAT and Dr. Doseob Ahn from ETRI as a representative of KOSST. They remarked the great

success of the conference and noted a plan for the next conference in Korea in 2014.



Fig. 1 Opening speech from Prof. Masazumi Ueba of IEICE SAT

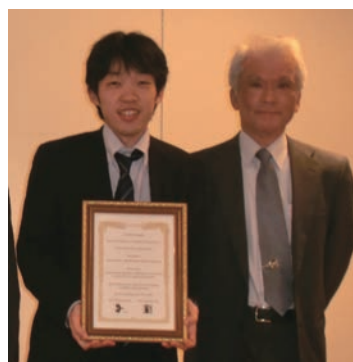

Fig. 2 The JC-SAT Award winner and the presenter



Fig. 3 JC-SAT 2013 Participants

Report on the 27th Optical Communication Systems Symposium

“Future of optical communication created by global strategy ~ scenario toward new stage ~”



Technical Committee on Optical Communication Systems

1. Overview

The 27th Optical Communication Systems (OCS) Symposium, sponsored by the IEICE Technical Committee on OCS, and in cooperation with the IEEE Photonics Society Japan Chapter, the IEEE Communications Society Japan Chapter, and the IEICE Technical Committees on Photonic Network (PN) and Extremely Advanced Optical Transmission Technologies (EXAT), was held on Dec. 12–13, 2013 at the Toray Human Resources Development Center in Mishima City. The title of the symposium was “Future of optical communication created by global strategy ~ scenario toward new stage ~”. The symposium agenda is shown in Table 1. There were 213 participants. This symposium included 27 poster presentations from young researchers and three award winners. There was also an exhibition of the products of 24 companies in the lobby adjacent to the conference room.

Table 1. Symposium agenda

Date	Program
Dec. 12	1. Opening Remarks
	2. Keynote Speech
	3. OCS Award Ceremony
	4. Workshop I
	5. Reception
	6. Rump Session
Dec. 13	7. Invited Lectures
	8. IEEE Communications Society JC and IEEE Photonics Society JC Invited Lectures
	9. Workshop II
	10. Closing Remarks

2. First day – Dec. 12

At the opening session of the symposium, Mr. Takashi Mizuochi, the IEICE OCS committee chair, presented the opening address. He reported the activities of the OCS technical committee in 2013. Regarding IEICE general/society meetings, we hosted eight normal technical meetings and two special sessions in 2013.

The technical sessions began with a keynote speech entitled “Innovation in science economy era and Japanese industrial competitiveness” given by Prof. Kazuyuki Motohashi of the University of Tokyo. (Fig. 1). First, he talked about the tendency of current economic conditions to limit growth as the result of holding to a traditional “industrial economy”. Subsequently, he emphasized the importance of an open innovation strategy to overcome in the “science economy era”.



Fig. 1 Keynote speech by Prof. K. Motohashi.

The OCS award ceremony was held after the keynote speech (Fig. 2). The OCS Technical Committee presented two awards: The “IEICE Communication Society OCS Best Paper Award” and the “IEICE Communication Society OCS Young Researchers Award” for excellent presentations at OCS technical committee meetings throughout the year. One paper was selected for the Best Paper Award:

- “Analysis of the effect of phase noise mitigation using pilot tone” by Mr. Mitsuteru Yoshida, Mr. Etsushi Yamazaki, Mr. Takayuki Kobayashi, Mr. Akihide Sano, and Mr. Yutaka Miyamoto, of NTT Network Innovation Lab.

Two researchers received Young Researchers Awards:

- Mr. Yoshihiro Yasumura (Osaka Univ.): “Frequency domain equalization for optical coherent receivers with time-interleaved oversampling”. Prof. A. Maruta attended the ceremony in his place.
- Mr. Hiroki Hamaguchi (Fujikura Ltd.): “Longitudinal power decay along a weakly coupled multi-core fiber”.

The OCS chair presented a testimonial, a glass trophy, and a book token to each award recipient.



Fig. 2 OCS award-winners: from left, Mr. H. Hamaguchi, Prof. A. Maruta, Mr. M. Yoshida, Mr. T. Kobayashi, and Mr. Y. Miyamoto. Presenter: Mr. T. Mizuochi (3rd from left).

After the award ceremony, Workshop I “ICT international competitive strategy learned from world’s successful example” was chaired by Mr. Kenro Sekine of Hitachi Ltd. The workshop included four invited talks (Fig. 3) (1) Recurrence from module type to

integration type, (2) Global R&D and business development of Huawei on optical transmission market, (3) Broadcom drives the next wave of innovation, and (4) Product development in rapidly growing global company ~ secret of the power ~.



Fig. 3 Presenters of Workshop I: from left, Prof. T. Tanaka, Mr. M. Takihiro, Mr. J. Oda, and Mr. M. Oguro.

The rump session began after the reception. The title was “Let’s talk about dreams of optical communication.” Following talks by three representative speakers (Prof. Hiroyuki Uenohara of Tokyo Institute of Technology, Prof. Joji Maeda of Tokyo Univ. of Science, and Prof. Masanori Hanawa of Univ. of Yamanashi), the attendees talked enthusiastically about their dreams. The able chairman, Mr. Kazushige Yonenaga of NTT Network Innovation Lab., produced a friendly atmosphere for this session.

3. Second day – Dec. 13

The second day began with a technical session consisting of five invited lectures designed to enhance participants’ knowledge of the future of optical communications (Fig. 4). The first invited lecture, given by Mr. Takaaki Sugiura of Mitsubishi Research Institute Inc., was entitled “ITS – Future of the car created by information and communication technologies”. He introduced the current development of devices for automobiles using information and communication technologies such as navigation systems, driver interfaces, safe driving systems, and automated driving systems, and discussed the future prospects of the car society. The second lecture, by Prof. Kazuhiko Fukawa of Tokyo Institute of Technology, was entitled “Transmission experiment of super high bit-rate mobile communication system in the 11 GHz band”. He introduced experimental results related to 8 x 16 MIMO-OFDM transmission toward the realization of super high bit-rate mobile communication at over 10 Gbit/s. The third lecture, given by Mr. Koichiro Seto of Ciena Corp., was entitled “The history of Ethernet ~ In commemoration of Ethernet’s 40th anniversary ~”. He introduced the origin and evolution of the Ethernet, which celebrated its 40th birthday this year. He also introduced the increasingly close relationship between Ethernet and optical transmission. The fourth lecture was sponsored by the IEEE Communications Society Japan Chapter. The lecture was given by Mr. Katsuhiko Shimano of NTT Network Innovation Lab., and was entitled “Research and development trends in SDN, NFV and approaches to realize flexible NW”. He introduced research and development trends in flexible networking

technology such as Software Defined Networking (SDN) and Network Function Virtualization (NFV). He also introduced the O₃ project (Open Innovation over Network Platform) as current work. The last lecture was sponsored by the IEEE Photonics Society Japan Chapter. The lecture was given by Mr. Shu Namiki of AIST, and was entitled “Applications of optical nonlinear process in optical fiber to optical communication and their future prospects”. He provided a review of development of optical communication technologies with nonlinear phenomena in optical fiber, and introduced research using an optical parametric process being undertaken at AIST.



Fig. 4 Presenters at the invited lecture session: from left, Top: Mr. T. Sugiura, Prof. K. Fukawa, and Mr. K. Seto. Bottom: Mr. K. Shimano, and Mr. S. Namiki.

The final session, chaired by Mr. Kiyoshi Fukuchi of NEC Corp., was Workshop II, entitled “400G/1T optical communication technologies which we would like to listen to, if nothing else.” The workshop included four invited talks (Fig. 5). The invited speakers presented (1) Trends in the standardization, research and development of 400G/1T optical communication technology, (2) Ultra low loss pure silica core fiber that supports 400G/1T transmission, (3) Narrow linewidth and tunable laser source for 400G/1T transmission, and (4) Problems and approaches for the practical application of a 400G/1T transmission system ~ Improvement of digital signal processing and challenging nonlinear limits ~.



Fig. 5 Presenters of Workshop II: from left, Mr. T. Ohara, Mr. M. Hirano, Mr. T. Mukaiharu, and Mr. T. Hoshida.

4. Conclusion

We believe that all the participants in this symposium were satisfied with the presentations and discussions on the future of optical communication created by global strategy. Finally, the OCS technical committee would like to thank all the speakers and participants for their efforts.

ICSANE2013 – Collaboration with Space Community in AsiaPacific

Masanobu Tsuji
Japan Aerospace Exploration Agency (JAXA)



1. Introduction

The International Conference on Space, Aeronautical and Navigational Electronics 2013 (ICSANE2013) was held at Vietnam Academy of Science and Technology (VAST) and Melia Hotel in Hanoi, Vietnam on December 2nd and 3rd, 2013. It was co-organized by the Technical Committee on Space, Aeronautical and Navigation Electronics (SANE) of IEICE and Vietnam National Satellite Center (VNSC) with support of National Institute of Information and Communications Technology (NICT, Japan), Electronic Navigation Research Institute (ENRI, Japan), Japan Aerospace Exploration Agency (JAXA), VAST (Vietnam), IEEE Aerospace and Electronics Systems Society (AEISS) Japan chapter and IEEE Geoscience & Remote Sensing Society (GRSS) Japan chapter. The conference was held in two days and collocated with Communication Satellite Applications Working Group (CSA-WG) meeting of the 20th Asia-Pacific Region Space Agency Forum (APRSAF-20) on the 2nd day.

A total of 104 people from Japan, Vietnam, Germany, Italy, Korea, Malaysia, Pakistan, Philippines, Singapore, Sri Lanka, Thailand, Turkey and Mekong River Committee have participated and there were 36 presentations in 2 days.

VNSC kindly provided logistic support for ICSANE2013. Also, VNSC took a group photo and gifted a photo frame to all participants for their memory (Fig.1).



Fig. 1 Group photo of the 1st day participants

2. Opening Ceremony

The opening ceremony was held on the first day on December 2nd. The opening remarks were given by Prof. Hirobumi Saito (JAXA, Japan) and Dr. Pham Anh Tuan (VNSC, Vietnam) co-chair persons of ICSANE2013 (Fig.2). Dr. Tuan introduced recent space activity in his speech, such as successful deployment of the first VNSC's Cubesat "PicoDragon" from Japanese Experimental Module "Kibo" of International Space Station in November, 2013.



Fig. 2 Opening remark by Prof.Saito

3. Technical Session

The covered area of ICSANE2013 were as follows.

- Satellite and space-station systems
- Remote sensing and scientific observation technology
- Radar systems and applications
- Navigational and communication systems

After reviewing process of the technical program committee formulated by international members from Japan, Bangladesh, Indonesia, Korea, Malaysia, Singapore and Vietnam, 36 papers were accepted for presentation. In ICSANE2013 we had 7 technical sessions. UWB and Radar session, Remote sensing and SAR session, Remote sensing and Positioning session, Satellite component and Technology session were held on the 1st day. Small satellite session, Positioning and navigation session were held on the 2nd day. The steering committee has arranged the sessions focusing to theory and basic technology on the 1st day and the sessions focusing to satellite system to the 2nd day.

4. Awarding Ceremony

The Technical Program Committee conducted a review to determine the recipients and had an onsite meeting on the 2nd day, December 3rd. The committee conferred the Young Scientist Awards to 2 persons listed below. The awards ceremony was held as a part of closing ceremony of ICSANE2013.

Ms. Dan-Bee Hong (Fig.3)

University of Science and Technology (UST), Korea
"Velocity Measurement of Internal Waves in the South China Sea by Multi-Temporal and Multi-Sensor Satellite Images"

Mr. Le Xuan Huy

Tokyo Institute of Technology (Tokyo Tech), Japan
"TSUBAME Microsatellite: Design, Development and Verification of Attitude Determination and Control System"

The organizing committee has also awarded the certificate of appreciation to Prof. Pham Anh Tuan (Co-chair) and VNSC staffs in recognition to outstanding contributions to the ICSANE 2013 (Fig.4).



Fig. 3 Awarding Ms. Dan-Bee Hong



Fig. 4 Awarding VNSC staffs for their contribution

5. Collaboration with Space Community

It was the first trial to collocate ICSANE and a working group meeting of the Asia-Pacific Regional Space Agency Forum (APRSAF). APRSAF was established in 1993 to enhance space activities in Asia-Pacific Region. Over 420 people from 28 countries and 6 international organizations have participated APRSAF-20 in Hanoi, Vietnam. The Communication Satellite Applications Working Group (CSA-WG) is one of 4 working groups in APRSAF and its participants are around 50 from space agencies, government, and international organizations as well as companies, universities and research institutes. The main topics of CSA-WG are communication satellite, SAR satellite, global navigation satellite system, satellite AIS, space debris and so on. The covered area of ICSANE and CSA-WG is very close and related each other. We are confident that collocation of ICSANE and CSA-WG can derive good influence for both of them. The participants of ICSANE2013 could know space community's needs and the participants of CSA-WG could get information of cutting edge technology in this field.

6. Future Plan of ICSANE

We are planning to hold the ICSANE2014 in Maracca, Malaysia in October 2014. We would like to encourage you to submit papers, make presentations and discuss on your research results at ICSANE2014.

7. Acknowledgements

The conference would like to express gratitude and appreciation to all members of the organizing committee and the technical program committee, especially to Dr. Pham Anh Tuan and VNSC staffs. Without their outstanding contribution we couldn't have the conference smoothly.

Also, we would like to appreciate National Institute of Information and Communications Technology (NICT, Japan), Electronic Navigation Research Institute (ENRI, Japan), Japan Aerospace Exploration Agency (JAXA), VAST (Vietnam), IEEE Aerospace and Electronics Systems Society (AESS) Japan chapter and IEEE Geoscience & Remote Sensing Society (GRSS) Japan chapter for their kind support to ICSANE2013.

8. Reference

- [1] ICSANE2013 official website,
http://www.ieice.or.jp/cs/sane/ICSANE2013/report_icsane2013.html
- [2] IEICE Technical Report SANE2013 (2013-12)
- [3] APRSAF official website,
http://www.aprsaf.org/annual_meetings/aprsaf20/meeting_details.php

Report on the 5th Workshop of Internet Architecture in Seoul, Korea

Keisuke Ishibashi

Chair, Technical Committee of Internet Architecture, IEICE



1. Introduction

The Technical Committee on Internet Architecture (TCIA) has held international workshops since 2009, aiming for further internationalization of IEICE. This year, TCIA successfully organized the 5th international workshop at Seoul, Korea, on Oct. 10 and 11, 2013, with dedicated supports of IEICE Korea Communication Section, OSIA (Open Standard & Internet Association), SMCC (Center for Social Media Cloud Computing), UBITA (Ubiquitous Information Technology and Application) Institute of Konkuk University and ViaScope International Inc. This article is a brief report on the workshop activities.

2. Workshop Overview

Prof. Changkyu Park, Director of UBITA, Konkuk University, provided the opening speech to welcome the workshop. Then, we had two days program including two keynote addresses, four invited talks and 13 technical talks.

Two keynote addresses were provided;

- Liberal Arts and ICT, Prof. Choon Seon Hong (President, OSIA and IEICE Korea Communication Section)
- Cloud Computing : The Present and Future, Prof. Hanku Lee (Director, SMCC, Konkuk University)

Further, following four invited talks were presented about hot topics on the future Internet; mobile IP, IPv6, SDN, and Big Data;

- “Mobile IP: Issues and Trend,” Sinchai Kamolphiwong
- “An Address Management System for IPv6 Network,” Sangwook Bae, Shimin Sun, Han Li and Sunyoung Han
- “Challenges and Applications of SDN in Interop Tokyo ShowNet 2013,” Yuji Sekiya
- “Cardinality in Big Data -- Examples in L3&L7 Network --,” Takeshi Mitamura and Kenichi Yoshida.



Fig. 1 Keynote speech by Prof. Choon Seon Hong

13 technical talks were presented in the following six sessions; 1) Network Security, 2) Overlay and Information/Content Centric Network, 3) Cloud Networking and Content-Centric Networking, 4) Network Protocols, 5) Network Control Open Flow and 6) DDOS, Privacy, Ecology. For those presentations, the student research awards were presented at the end of two days fruitful workshop. In addition to the technical talks and discussions, in the evening of the first day, participants enjoyed Thai cuisine at the banquet, sponsored by ViaScope International Inc.

3. Conclusion

We believe that all participants were satisfied with the presentations, discussions and experience exchanging. TCIA thanks to all the speakers and participants for their efforts. TCIA also thanks for warm hospitality by faculty member of Konkuk, specifically Prof. Sunyoung Han, Konkuk University, Korea

We welcome you to join the next workshop. Please visit the TCIA web page for more update information; <http://www.ieice.org/~ia/eng/index.php>.



Fig. 2 Closing remarks by Prof. Sunyoung Han



Fig. 3 Workshop participants

Special Section Calendar of IEICE Transactions on Communications

Issue	Special Section	Note
Mar. 2015	Position Papers Exploring Innovative Intelligence and Technologies in Communications	Submission due: 1 June 2014 See page 26
Feb. 2015	Quality of Diversifying Communication Networks and Services	Submission due: 30 April 2014 See page 27
Jan. 2015	Position Papers Exploring Innovative Intelligence and Technologies in Communications	Submission due: 1 April 2014 See page 26
Dec. 2014	Technologies and Architectures for Improving Scalability, Reliability, and Robustness for Future Information Networks	Submission due: 16 March 2014 See page 25
Nov. 2014	Network Virtualization, and Fusion Platform of Computing and Networking	Submission due: 3 March 2014 See page 24
Oct. 2014	Recent Progress in Measurement and Design Techniques on Antennas, Propagation and Wireless Systems	To be issued
Sep. 2014	Ambient Intelligence and Sensor Networks	To be issued
Aug. 2014	EU's FP7 ICT R&D Project Activities on Future Broadband Access Technologies in Conjunction with Main Topics of 2013 IEICE ICT Forum	To be issued
Jul. 2014	Opto-electronics and Communications for Future Optical Network	To be issued
Jun. 2014	No special section in this issue	
May 2014	No special section in this issue	
Apr. 2014	No special section in this issue	
Mar. 2014	Information and Communication Technology for Medical and Healthcare Applications in Conjunction with Main Topics of ISMICT2013	Vol. E97-B, No. 3
Jan. 2014	Management for Flexible ICT Systems and Services	Vol. E97-B, No. 1

Please confirm with the following IEICE web site for the latest CALL FOR PAPERS
<http://www.ieice.org/event/ronbun-e.php?society=cs>

Call for Papers

----- Special Section on Network Virtualization, and Fusion Platform of Computing and Networking -----

The IEICE Transactions on Communications announces that it will publish a special section entitled "Special Section on Network Virtualization, and Fusion Platform of Computing and Networking" in November 2014.

While the Internet has become indispensable social infrastructure for supporting our social and economic activities, its various issues have been also addressed in the areas of security, availability, robustness, etc. It is necessary to innovative information and communication infrastructure such as the Internet in order to enable platforms to deliver communication services that meet demands from the users in a prompt and flexible manner. The merge of computing and networking has been gaining its acceleration and the benefit of systematically consolidating computing, networking, and storage resources and dynamically and elastically utilizing them has recently caught our attention.

Advanced network virtualization is the key to realizing such ICT infrastructure and is expected to enable coexistence of multiple customized networks, prompt delivery of innovative network functionalities, programmable network within isolated resources, stable operation and management of massive ICT systems, extension of cloud computing to networking, and secure service infrastructure.

We thus call for publications (scheduled to appear in the November 2014 issue) for promoting discussion and development of technologies on advanced network virtualization and on fusion of computing and networking.

1. Scope

This special section aims at timely dissemination of research in these areas. Possible topics include, but are not limited to:

- Network virtualization architecture for enabling multiple customized networks
- Innovative applications based on network virtualization
- Fusion of networking and computing
- Operation and management of integrated multi-layer networks and network virtualization
- Resources monitoring for network virtualization
- Data center networking based on network virtualization
- Operating systems and network virtualization
- Software defined network
- Network function virtualization
- Security for network virtualization and secure services
- Scalability & impact on data center design
- Testbeds for above technologies and experimental results

2. Submission Instructions

The standard number of pages is 8. The page charges are considerably higher for extra pages. Manuscripts should be prepared according to the guideline in the "Information for Authors". The latest version is available at the web site, http://www.ieice.org/eng/shiori/mokuji_cs.html. The term for revising the manuscript after acknowledgement of conditional acceptance for this special section could be shorter than that for regular issues (60 days) because of the tight review schedule. This special section will accept papers only by electronic submission. Prospective authors are requested to follow carefully the submission process described below.

1. Submit a manuscript and electronic source files (TeX/Word files, figures, authors' photos and biographies) via the IEICE Web site https://review.ieice.org/regist/regist_baseinfo_e.aspx **by March 3, 2014 (Japan Time)**. Authors should choose the "Network Virtualization, and Fusion Platform of Computing and Networking" as a "Journal/Section" on the online screen. **Do not choose [Regular-EB]**.
2. Send "Copyright Transfer and Page Charge Agreement" and "Confirmation Sheet of Manuscript Registration" by E-mail or FAX to the following address (guest editor of the special section) by the above due date. We may withdraw the submission if these documents have not been received by the due date, even if the manuscript has been received by electronic submission. For additional guidelines on manuscript preparation, please visit: http://www.ieice.org/eng/shiori/mokuji_cs.html

Send the above documents to:

Atsushi Tagami

KDDI R&D Laboratories, Inc,

Tel: +81-49-278-7365, Fax: +81-49-278-7510 Email: nv+paper@mail.ieice.org

3. Special Section Editorial Committee

Guest Editor-in-Chief: Katsuhito Shimano (NTT)

Guest Editors: Atsushi Tagami (KDDI R&D Laboratories), Hiroshi Shigeno (Keio University)

Guest Associate Editors: Masaki Aida (Tokyo Metropolitan University), Katsuyoshi Iida (Tokyo Institute of Technology), Tomohiro Ishihara (Fujitsu Laboratories), Tomohiro Kudoh (AIST), Shigeki Goto (Waseda University), Fumio Teraoka (Keio University), Kiyohide Nakauchi (NICT), Hiroaki Harai (NICT), Masaki Fukui (NTT), Masayuki Murata (Osaka University), C.K.Toh (National Tsing Hua University), Wolfgang Kellerer (Technische Universität München)

* Please note that if accepted, all authors, including authors of invited paper, are requested to pay for the page charges covering partial cost of publications. Authors will receive 50 copies of reprints.

* At least one of the authors must be an IEICE member when the manuscript is submitted for review. Invited papers are an exception. We recommend that authors unaffiliated with IEICE apply for membership. For membership applications, please visit the web-page, <http://www.ieice.org/eng/member/OM-appli.html>

Call for Papers

----- Special Section on Technologies and Architectures for Improving Scalability, Reliability, and Robustness for Future Information Networks -----

The IEICE Transactions on Communications announces that it will publish a special section entitled "Special Section on Technologies and Architectures for Improving Scalability, Reliability, and Robustness for Future Information Networks" in **December 2014**.

In order to construct future information networks, many researches have been performed on various kinds of network technologies and architectures such as information/content centric networking (ICN/CCN), software-defined networking (SDN), data centers and cloud computing, delay/disruption/disaster tolerant networks (DTN), and so on. These network technologies and architectures are considered to possess the features of scalability, reliability, and robustness so that they can provide high quality communication services while adapting to changing circumstances and disturbances. In order to further promote the research on scalability, reliability, and robustness of future information network technologies and architectures by timely dissemination of currently available research results, this special section has been scheduled to appear in the December 2014 issue.

1. Scope

The scope of this special section includes, but is not limited to, the following topics:

- Future information network design
- Network virtualization
- ID/locator split-based architecture
- Sensor networks
- Wireless-wireline internetworking
- Smart grid networks
- Network planning and management
- Social networks
- Information/content centric networking (ICN/CCN)
- Data centers and cloud networking
- Delay/disruption/disaster tolerant networks (DTN)
- Embedded systems networking
- Optical network architecture
- Smart home networks
- Survivability and fault tolerance
- Self-organization networks
- Software-defined networking (SDN)
- Mobility-oriented architectures
- New naming and addressing
- RFID networks and protocols
- Overlay networking
- Environment monitoring networks
- Anomaly/intrusion/attack detection
- Future network testbed systems

2. Submission Instructions

The standard number of pages is eight (8). The page charges are considerably higher for extra pages. Manuscripts should be prepared according to the "Information for Authors" guideline available at http://www.ieice.org/eng/shiori/mokuji_cs.html. The time available for revising the manuscript after receiving the result of conditional acceptance for this special section could be shorter than that for regular issues (60 days) because of the tight review schedule.

This special section will accept papers only by electronic submission. Prospective authors are requested to follow carefully the submission process described below.

1. Submit a manuscript (PDF file) and electronic source files (TeX/Word files, figures, authors' photos and biographies) via the IEICE website https://review.ieice.org/regist/regist_baseinfo_e.aspx by **March 16, 2014 (JST)**. Authors should choose the Technologies and Architectures for Improving Scalability, Reliability, and Robustness for Future Information Networks as a "Type of Section (Issue)" on the submission webpage. Do not choose [Regular-EB].

2. Send "Copyright Transfer and Page Charge Agreement" and "Confirmation Sheet of Manuscript Registration" by E-mail or FAX to the following address (guest editor of the special section) by the above due date. We may withdraw the submission if these documents have not been received by the due date, even if the manuscript has been received by electronic submission. For additional guidelines on manuscript preparation, please visit http://www.ieice.org/eng/shiori/mokuji_cs.html.

Send the above documents to:

Takuji Tachibana

Graduate School of Engineering, University of Fukui

Address: 3-9-1 Bunkyo, Fukui City, Fukui Prefecture 910-8507, Japan

Tel: +81-776-27-9971, Fax: +81-776-27-8751, Email: in_ac-tokushu-kanji-2013@mail.ieice.org

3. Special Section Editorial Committee

Guest Editor-in-Chief: Tohru Asami (Univ. of Tokyo)

Guest Editors: Ved Kafle (NICT), Takuji Tachibana (Univ. of Fukui)

Guest Associate Editors: Shingo Ata (Osaka City Univ.), Masayuki Ariyoshi (ATR), Satoshi Ohzahata (Univ. of Electro-Communications), Kenji Kawahara (Kyushu Inst. of Tech.), Takuo Suganuma (Tohoku Univ.), Yuzo Taenaka (Univ. of Tokyo), Masahide Nakamura (Kobe Univ.), Osamu Mizuno (Kogakuin Univ.), Junichi Murayama (NTT), Kiyohito Yoshihara (KDDI R&D Labs)

* Please note that if the submitted paper is accepted, all authors, including authors of invited papers, are requested to pay for the page charges covering partial cost of publications. Authors will receive 50 copies of reprints.

* At least one of the authors must be an IEICE member when the manuscript is submitted for review. Invited papers are an exception. We recommend that authors unaffiliated with IEICE apply for membership. For membership applications, please visit <http://www.ieice.org/eng/member/OM-appli.html>

Call for Papers

----- Special Section of Position Papers Exploring Innovative Intelligence and Technologies in Communications -----

The IEICE Transactions on Communications announces that it will publish a special section entitled "Special Section of Position Papers Exploring Innovative Intelligence and Technologies in Communications" in the Jan. 2015 issue and in the Mar. 2015 issue.

Expansion of the field of communications has unlimited boundaries, and research and development (R&D) has been continuously pursued to support this expansion. A lot of new key ideas are emerging and open up novel research areas, which become driving force of further development of communications technologies. Aiming at the world's best performance has been also one of the major driving forces of R&D, and its resulting outputs lead to the stimulation of the R&D itself in turn. This special section will be publishing *position papers*, which exhibit novel ideas and/or significant achievements leading to such innovative technologies. There are two deadlines of the submission, and correspondingly, this special section will be published in two issues (scheduled to appear in the Jan. 2015 issue and in the Mar. 2015 issue). Moreover, for the wide promotion of the papers in this special section, all accepted papers will be

- introduced in GLOBAL NEWSLETTER published by IEICE Communications Society,
- available by open access through the website of the IEICE Transactions on Communications.

1. Scope

This special section aims at whole research areas covered by the IEICE Transactions on Communications, such as Fundamental Theories for Communications, Fiber-Optic Communications, Networking, Antennas and Propagation, and Wireless Communications. In this special section, POSITION PAPERS are defined as papers having at least one of the following features:

- introduction of novel viewpoints, frameworks, and/or paradigms
- proposal of technologies or methods based on innovative ideas (not just extension of existing technologies)
- novel ideas with the potential to bring about innovative technologies
- prototyping or experimental results with noteworthy features, such as achievement of the world's best performance or the world's first realization

In this special section, only papers having the significant feature(s) above will be accepted, while comprehensive evaluations of the performance or the effectiveness will not be required.

2. Submission Instructions

In view of the scope of this special section, the paper is assumed to be shorter (around 4 pages) than the regular paper (the standard number of pages is 8), although there is no restriction on the number of pages. The page charges are considerably higher for extra pages exceeding 8 pages. Manuscripts should be prepared according to the guideline in the "Information for Authors". The latest version is available at the web site, http://www.ieice.org/eng/shiori/mokuji_cs.html. Please note that the paper will be handled and published as a PAPER defined in "1.1 Type of Manuscript" of "Information for Authors". The term for revising the manuscript after acknowledgement of conditional acceptance for this special section could be shorter than that for regular issues (60 days) because of the tight review schedule.

This special section will accept papers only by electronic submission. Prospective authors are requested to follow carefully the submission process described below.

1. Submit a manuscript and electronic source files (LaTeX/Word files, figures, authors' photos and biographies) via the IEICE Web site https://review.ieice.org/regist/regist_baseinfo_e.aspx by **April 1, 2014 (JST) for the publication in January 2015, and by June 1, 2014 (JST) for the publication in March 2015**. Authors should choose the **Position Papers Exploring Innovative Intelligence and Technologies in Communications** as a "Journal/Section" on the online screen. Do not choose [Regular-EB].
2. Send "Copyright Transfer and Page Charge Agreement" and "Confirmation Sheet of Manuscript Registration" by E-mail or Fax to the following address/Fax number (guest editor of the special section) by the above due date. We may not accept the submission if these documents have not been received by the due date, even if the manuscript has been received by electronic submission. For additional guidelines on manuscript preparation, please visit: http://www.ieice.org/eng/shiori/mokuji_cs.html

Send the above documents to:

Kazunori Hayashi

Graduate School of Informatics, Kyoto University

Tel: +81-75-753-5509, Fax: +81-75-753-5509, E-mail: positionpapers@sys.i.kyoto-u.ac.jp

3. Special Section Editorial Committee

Guest Editor-in-Chief: Hisato Iwai (Doshisha Univ.)

Guest Editors: Kazunori Hayashi (Kyoto Univ.), Takahiro Matsuda (Osaka Univ.)

Guest Associate Editors: Shingo Ata (Osaka City Univ.), Keizo Cho (Chiba Institute of Technology), Motohiko Isaka (Kwansei Gakuin Univ.), Shoji Kasahara (Nara Institute of Science and Technology), Tadashi Minowa (NICT), Hiraku Okada (Nagoya Univ.), Shigeo Shioda (Chiba Univ.), Shinji Sugawara (Chiba Institute of Technology), Satoshi Suyama (NTT DOCOMO), Takuji Tachibana (Univ. of Fukui), Daisuke Umehara (Kyoto Institute of Technology), Kazuto Yano (ATR)

* Please note that if the submitted paper is accepted, all authors are requested to pay for the page charges covering partial cost of publications. **Note also that, in this special section, all authors will be exempted from the page charges up to the fee required for 50 reprints of 4 pages with electronic source data using the IEICE LaTeX style file.**

* At least one of the authors must be an IEICE member when the manuscript is submitted for review. Invited papers are an exception. We recommend that authors unaffiliated with IEICE apply for membership. For membership applications, please visit: <http://www.ieice.org/eng/member/OM-appli.html>

Call for Papers

Special Section on Quality of Diversifying Communication Networks and Services

The IEICE Transactions on Communications announces that it will publish a special section entitled "Special Section on Quality of Diversifying Communication Networks and Services" in **January 2015**.

With the progress of seamless wired/wireless network technologies and advancement of communication terminals such as smartphones, diversified communication services have been provided through communication networks. In addition to infrastructure improvements, e.g. broadband access networks, network virtualization technologies, cloud technologies, and multimedia compression technologies, the stable provision of diversified services requires advanced operation, management, and assessment techniques. To meet such quality requirements and provide secure and reliable network services, it is important to build technologies for measuring, assessing, managing, and visualizing the communication quality, and network operation technologies. Because of such reasons, a special section is being planned (scheduled to appear in the January 2015 issue) to further promote research and development on the quality of diversifying communication networks and services.

1. Scope

This special section aims at timely dissemination of research in these areas. Possible topics include, but are not limited to:

- Measurement and control methodologies of wired/wireless networks
- Evaluation, modeling and use cases of reliability and security in wired/wireless networks
- Quality management systems based on measurement of wired/wireless networks and their use cases
- Network measurement, design and control methodologies for improving communication quality
- Modeling and simulation for improving communication quality
- Network quality and quality of experience (QoE)
- Assessment and management of QoE
- Subjective and objective quality assessments of voice, audio, and video media
- Quality of ultra-realistic communication and multi-sensory media communication
- Quality of services and incentive/user utility/user behavior
- Evaluation, modeling and use cases of service satisfaction
- Novel concept of communication quality

2. Submission Instructions

The standard number of pages is 8. The page charges are considerably higher for extra pages. Manuscripts should be prepared according to the guideline in the "Information for Authors". The latest version is available at the web site, http://www.ieice.org/eng/shiori/mokuji_cs.html. The term for revising the manuscript after acknowledgement of conditional acceptance for this special section could be shorter than that for regular issues (60 days) because of the tight review schedule.

This special section will accept papers only by electronic submission. Prospective authors are requested to follow carefully the submission process described below.

1. Submit a manuscript and electronic source files (TeX/Word files, figures, authors' photos and biographies) via the IEICE Web site https://review.ieice.org/regist/regist_baseinfo_e.aspx **by April 30, 2014 (JST)**. Authors should choose Quality of Diversifying Communication Networks and Services as a "Journal/Section" on the online screen. Do not choose [Regular-EB].
2. Send "Copyright Transfer and Page Charge Agreement" and "Confirmation Sheet of Manuscript Registration" by E-mail or FAX to the following address (guest editor of the special section) by the above due date. We may withdraw the submission if these documents have not been received by the due date, even if the manuscript has been received by electronic submission. For additional guidelines on manuscript preparation, please visit: http://www.ieice.org/eng/shiori/mokuji_cs.html

Send the above documents to:

Ryogo Kubo

Department of Electronics and Electrical Engineering, Keio University

Tel: +81-45-566-1763, Fax: +81-45-566-1529, Email: cq_ac-eb15@mail.ieice.org

3. Special Section Editorial Committee

Guest Editor-in-Chief: Hideaki Yoshino (Nippon Inst. Tech.)

Guest Editors: Ryogo Kubo (Keio Univ.), Hideyuki Shimonishi (NEC)

Guest Associate Editors: Koichi Gyoda (Shibaura Inst. Tech.), Masaaki Kurozumi (NHK), Akira Takahashi (NTT), Takashi Taniguchi (Osaka Gakuin Univ.), Masato Tsuru (Kyushu Inst. Tech.), Kiyohide Nakauchi (NICT), Go Hasegawa (Osaka Univ.), Toru Hasegawa (Osaka Univ.), Kenji Hikichi (Fujitsu Labs.), Takeshi Yamada (Univ. Tsukuba), Hisao Yamamoto (Tokyo City Univ.), Kyoko Yamori (Asahi Univ.)

* Please note that if the submitted paper is accepted, all authors, including authors of invited papers, are requested to pay for the page charges covering partial cost of publications. Authors will receive 50 reprints.

* At least one of the authors must be an IEICE member when the manuscript is submitted for review. Invited papers are an exception. We recommend that authors unaffiliated with IEICE apply for membership. For membership applications, please visit <http://www.ieice.org/eng/member/OM-appli.html>



Membership for Overseas Candidates: Overseas Members may opt to join **one IEICE Society of their choice** and may request to receive the **IEICE Transactions of online version** of that Society. Furthermore, Overseas Members may request to receive the IEICE Journal (written in Japanese) and Transactions (published in paper) at an additional cost. Similar services are available to **Overseas Student Members**. Voting privileges in the IEICE election do not apply to Overseas Members. Note that the Overseas Membership applies only to candidates who reside outside of Japan and who have citizenship in countries other than Japan.

OMDP (Overseas Membership Development Program): OMDP is provided for candidates **from countries/areas in Asia (except Republic of Korea and Taiwan), Africa, Central America, and South America**. This program is designed so that IEICE can contribute to and support the progress of science and technology throughout the world. Scientists and engineers in these countries/areas are encouraged to apply to the program.

● **IEICE Societies and Publications**

Society	Transactions	Editorial Subject Indexes
A (Fundamentals of Electronics, Communications and Computer Sciences)	EA (English) A (Japanese)	Engineering Acoustics, Noise and Vibration, Speech and Hearing, Ultrasonics, Digital Signal Processing, Analog Signal Processing, Systems and Control, Nonlinear Problems, Circuit Theory, VLSI Design Technology and CAD, Numerical Analysis and Optimization, Algorithms and Data Structures, Graphs and Networks, Reliability, Maintainability and Safety Analysis, Cryptography and Information Security, Information Theory, Coding Theory, Communication Theory and Signals, Spread Spectrum Technologies and Applications, Mobile Information Network and Personal Communications, Intelligent Transport System, Image, Vision, Computer Graphics, Language, Thought, Knowledge and Intelligence, Human Communications, Neural Networks and Bioengineering, Multimedia Environment Technology, Communication Environment and Ethics, Concurrent Systems, Measurement Technology, General Fundamentals and Boundaries
B (Communications)	EB (English) B (Japanese)	Fundamental Theories for Communications, Devices/Circuits for Communications, Transmission Systems and Transmission Equipment for Communications, Optical Fiber for Communications, Fiber-Optic Transmission for Communications, Switching for Communications, Switching for Mobile Communications, Network, Network Management/Operation, Internet, Wireless Communication Technologies, Terrestrial Radio Communications, Satellite Communications, Optical Wireless Communications, Antennas and Propagation, Electromagnetic Compatibility (EMC), Sensing, Navigation, Guidance and Control Systems, Energy in Electronics Communications, Terminals for Communications, Multimedia Systems for Communications, Broadcast Systems, Integrated Systems for Communications, Space Utilization Systems for Communications
C (Electronics)	EC (English) C (Japanese)	Electromagnetic Theory, Lasers, Quantum Electronics, Optoelectronics, Microwaves, Millimeter-Waves, Ultrasonic Electronics, Electronic Circuits, Electronic Materials, Organic Molecular Electronics, Electronic Components, Electromechanical Devices and Components, Semiconductor Materials and Devices, Integrated Electronics, Electron Tubes, Vacuum and Beam Technology, Electronic Displays, Superconducting Electronics, Storage Technology, Electronic Instrumentation and Control
D (Information and Systems)	ED (English) D (Japanese)	Computation and Computational Models, Automata and Formal Language Theory, Algorithm Theory, Complexity Theory, Computer Components, VLSI Systems, Computer Systems, Fundamentals of Software and Theory of Programs, System Programs, Software Engineering, Database, Contents Technology and Web Information Systems, Data Mining, Networks, Dependable Computing, Application Information Security, Distributed Cooperation and Agents, Artificial Intelligence and Cognitive Science, Human-computer Interaction, Office Information Systems, e-Business Modeling, Educational Technology, Rehabilitation Engineering and Assistive Technology, Pattern Recognition, Speech and Hearing, Image Processing and Video Processing, Image Recognition, Computer Vision, Computer Graphics, Multimedia Pattern Processing, Natural Language Processing, Biocybernetics, Neurocomputing, Biological Engineering, Music Information Processing, Kansei Information Processing, Affective Information Processing
Journal of IEICE (written in Japanese only)		

● **Membership Charges (<http://www.ieice.org/eng/member/OM-appli.html#c>)**

Basic Membership Charge is as follows. It will change the term when you join IEICE. Please refer to the above website.

Basic Membership Charge (UNIT : Japanese YEN)

Service coverage for overseas members	Admission charge	Online Version		Paper Version (optional)		
		Registration of the first society (includes its online version transactions)	Registration of additional societies (includes its online version transactions)	Journal (written in Japanese)	Transactions (written in Japanese or in English)	
					(In one society)	
One title	Two titles					
Member (overseas)	1,400	7,000	3,500 / 1society	6,000	4,000	10,000
Member (overseas) with OMDP*	1,000	5,000	3,000 / 1society	5,000		
Student member (overseas)	-	2,000	2,000 / 1society	6,000		
Student member (overseas) with OMDP*	-	1,000	1,500 / 1society	5,000		

NOTE

- You need to choose one Society, and you can subscribe Transactions online of your registered society.
Example: If you want to subscribe to Transaction of EA, please check Society Registration as "A", and your membership fee amounts to 7,000 yen / 5,000 yen.
- If you want to register other Societies and Transaction of web version, please check "Additional Society registration".
Example: If you want to subscribe to Transaction of EA and EB, please check Society Registration as "A", Additional Society registration (optional) as "B". Your membership fee amounts to 7,000+3,500 yen / 5,000+3,000 yen.
- If you want to subscribe to one Transaction of paper version, please check "Additional Transaction subscription (published in paper)".
Example: If you want to subscribe to Transaction of EC in paper version additionally, please check Society Registration as "A", and Additional Transaction subscription (in paper version) as "C" or as "EC". Your membership fee amounts to 7,000+4,000 yen / 5,000+4,500 yen.
- If you want to change membership from Member (In Japan) to Overseas Member, you don't need to pay an Entrance charge.

● **Optional Rapid Mailing Service**

Surface mail charge is included in the membership charge. Optional rapid mailing service is available by air mail or surface air lifted (SAL) mail. The additional charge per year periodical depends on the mailing address, as shown in the right table.

Areas	Air mail	SAL mail
Asia; Guam; Midway islands	5,600 yen	3,200 yen
Oceania; Near & Middle East; North & Central America; Europe	7,800 yen	4,400 yen
Africa; South America	11,000 yen	5,600 yen

Please contact the IEICE Membership Section: E-mail: member@ieice.org FAX: +81 3 3433 6659 **Please fill out the application form printed on the opposite side of this page.**

IEICE Communications Society - GLOBAL NEWSLETTER Submission Guideline

First version in only Japanese: May 30, 2008
Second version in only Japanese: Feb. 13, 2009
Third version in only Japanese: Jul. 22, 2010
Forth version in English and Japanese: Mar. 8, 2011
Ver 5.0 : August 10 2013

1. About GLOBAL NEWSLETTER

The Institute of Electronics, Information and Communication Engineers Communications Society (IEICE-CS) GLOBAL NEWSLETTER has been established since 2002. We quarterly publish an English newsletter every March, June, September, and December.

1.1. Goal

Our goal is to share information between overseas/foreign members and other members in IEICE-CS as a global activity, and to show IEICE presence internationally.

1.2 Category of Articles

- 1) Messages from President/Vice President
 - An inaugural message from CS President is published once per year in June. Message from CS Vice President is published properly.
 - 2) IEICE-CS Activities Now
 - IEICE General/Society Conference information/reports
 - Activities of Technical Committees
 - International activities of the society
 - 3) IEICE-CS Related Conferences Reports
 - Information/reports on IEICE-CS related conferences
 - IEICE-CS Conferences Calendar (*)
 - 4) Others
 - Essays, Laboratory activity reports, Technology reports, Messages from overseas/foreign members, etc.
 - Information from Sister Societies
 - Special topics (*)
 - 5) IEICE-CS Information
 - Call for papers
 - From editor's desk (*)
- *: planned / written by IEICE-CS Directors, Planning and Members Activities

2. Major notes for Contribution

Basically, IEICE-CS members and readers can contribute articles. IEICE-CS Directors, Planning and Members Activities may ask non-IEICE-CS members to contribute articles. The articles should be fruitful and profitable for IEICE-CS members, **NOT** for particular organization. IEICE-CS Directors, Planning and Members Activities may not accept an article for publication if it does not follow this guideline.

2.1 Template and Language

Please use template downloadable at the URL:
http://www.ieice.org/cs/pub/global_howto.html
Please use English for all articles.

2.2 Number of pages

Two to four pages are preferable. One page article is also acceptable. The maximum number of pages is eight. When you try to entry a contribution with five to eight pages, you need to negotiate with IEICE-CS Directors, Planning and Members Activities.

3. Copyright

The copyrights of all articles in the GLOBAL NEWSLETTER should belong to the IEICE. However, the original authors retain the right to copy, translate or modify their own manuscripts. In cases when a manuscript is translated into another language or when any portion of the manuscript is to be submitted to another publication, authors

should register the action with the IEICE, and the original manuscript should be clearly cited in the publications. Please see a web site related to IEICE provisions on copyright.

<http://www.ieice.org/eng/about/copyright.html>

4. Publication fee / Manuscript fee

No publication fee and no manuscript fee for all articles.

5. Schedule

Standard editing schedule is as follows. Please note that the schedule may vary due to public holidays or other circumstances. The exact deadlines are indicated in call for newsletters.

Publication date	1 st , Mar.	1 st , Jun.	1 st , Sept.	1 st , Dec.
Call for newsletters	1 st Mon., Dec.	1 st Mon., Mar.	1 st Mon., Jun.	1 st Mon., Sept.
Contribution entry	4 th Fri., Dec.	4 th Fri., Mar.	4 th Fri., Jun.	4 th Fri., Sept.
Submission of Manuscript/Copyright	3 rd Fri., Jan.	3 rd Fri., Apr.	3 rd Fri., Jul.	3 rd Fri., Oct.

5.1 Call for Newsletters

IEICE-CS Directors, Planning and Members Activities will give you the information on call for newsletters.

5.2 Contribution Entry

You should send **information on title, summary(around 50 words or less) and number of page** to IEICE-CS Directors, Planning and Members Activities by e-mail.

E-mail: cs-gnl@mail.ieice.org

5.3 Submission of Manuscript

You should send a manuscript both in word file and pdf file to IEICE-CS Directors, Planning and Members Activities by e-mail.

E-mail: cs-gnl@mail.ieice.org

5.4 Submission of COPYRIGHT TRANSFER FORM

COPYRIGHT TRANSFER FORM can be downloaded at:

http://www.ieice.org/cs/pub/global_howto.html

Signed **COPYRIGHT TRANSFER FORM** should be sent by one of the following ways:

- By email.
- By facsimile.

Address to send:

- In case of email: cs-gnl@mail.ieice.org
- In case of facsimile:

Name: Publications Department, IEICE

Facsimile: +81-3-3433-6616, Phone: +81-3-3433-6692

6 Contact Point

IEICE-CS Directors, Planning and Members Activities in charge of IEICE-CS GLOBAL NEWSLETTER, cs-gnl@mail.ieice.org

From Editor's Desk

● Tablet PC and my little daughters

Tablet PC allows one of my daughters, who has just mastered how to read and write *Hiragana* characters to input her words by hand-writing recognition. It also allows the other daughter, who is only 2, to see video clips of her favorite cartoon characters by voice recognition. These would not be possible by keyboard and mouse. It was funny to see the little one repeatedly shouting “*daemon*” to the tablet PC, but what she wanted to see have never appeared. (If you know some of famous Japanese cartoon characters, you may guess what she wanted to see.) Daddy hopes little daughters to enjoy more advanced technologies and use it to develop their skills.

2014 IEICE General Conference is around the corner. Please participate and contribute to new technologies that small children can enjoy.

IEICE GLOBAL NEWSLETTER Editorial Staff

Editorial Staff of this issue

No special order is observed



Michiharu NAKAMURA

Fujitsu Laboratories, Ltd.

Network Systems Laboratories

Director, Planning and Member Activities, IEICE Communications Society



Fumio FUTAMI

Tamagawa University

Quantum ICT Research Institute

Director, Planning and Member Activities, IEICE Communications Society