

# Efficient numerically-assisted modelling of grounded arrays of printed patches

M. García-Vigueras <sup>\*</sup>, F. Mesa <sup>†</sup>, R. Rodríguez-Berral <sup>†</sup>, F. Medina <sup>‡</sup> and J. R. Mosig <sup>\*</sup>.

<sup>\*</sup> Laboratory of Electromagnetics and Acoustics, EPFL, 1015 Lausanne, Switzerland.

<sup>†</sup> Dept. de Física Aplicada 1, Universidad de Sevilla, 41012 Seville, Spain.

<sup>‡</sup> Dept. de Electrónica y Electromagnetismo, Universidad de Sevilla, 41012 Seville, Spain.

**Abstract**—A circuit model is here proposed to characterize grounded arrays of printed patches. This equivalent circuit reproduces the behavior of the structure in a wide frequency range with the only restriction of dealing with single resonant scatterers. Full-wave data is required to build some elements of the equivalent circuit. However, only a reduced number of simulations is needed, in contrast to other available techniques.

**Index Terms**—Circuit modeling, high impedance surface, frequency-selective surfaces, transmission lines.

## I. INTRODUCTION

Planar periodic arrays of scatterers printed on grounded dielectric substrates are well known for allowing their reflection phase and surface-wave properties to be tuned [1]. Basically, they can be seen as metal-backed printed frequency selective surfaces (FSS) [2]. In principle, with these compound surfaces it is possible to synthesize any desired boundary condition, from perfect electric conductor (PEC) to artificial magnetic conductor (AMC), and due to this reason they are also named as high impedance surfaces (HIS) [1]. Particularly, HIS perform as AMC around their resonance frequency, where they fully reflect incident waves with zero or near-zero phase shift. These composite layers also exhibit electromagnetic band gaps (EBG), which implies that no surface wave propagation is allowed at certain frequencies [3]. These interesting features have triggered the investigation of HIS and their use to suppress surface waves and to enhance the performance of antennas and microwave circuits. As a classical example, the profile of reflector-based antennas can be significantly reduced by employing an AMC ground plane, since it does not reverse the phase of reflected waves [1]. Aperiodic configurations of these surfaces can be found in many other microwave devices such as reflectarrays [4], printed/holographic/modulated leaky-wave antennas [5]–[7] and recently they have been also considered as metasurfaces [8]. In addition, considerable scientific attention has recently been drawn towards periodic planar structures not only as FSS layers [2], but also due to the advent of extraordinary optical transmission [9].

The previous context has motivated extensive research on the circuit modeling of arrays of scatterers printed on grounded dielectrics during the last decades. Analytical expressions have been derived using homogenization procedures (such as in [10]), these approaches are accurate but only in the

long wavelength regime. More versatile methods can also be found in the literature, as the one proposed in [11], but, as they are essentially rational fitting procedures, they rely on considerable amounts of full-wave simulations. Recently, a very simple circuit model has been proposed that can predict the response of generic FSS systems [12]. Still, this procedure needs an *a priori* knowledge of the full-wave system response and it is limited to scenarios where high-order modal interaction is not relevant. In order to develop accurate, wideband and versatile models, the physical insight of the structure needs to be captured, which is the goal of the present work. For this purpose, it is of key importance to characterize properly the launch of surface waves in the dielectric slab as well as the interaction between the scattered reactive field and the ground plane.

In this contribution we propose a very simple and quasi-analytical circuit to model arrays of patches printed on grounded dielectric slabs. Some of the authors presented recently a simple and wideband transverse equivalent circuit (TEN) to characterize printed arrays of patches [14]. This TEN is based on a physically meaningful approach [13], and built from sections of transmission lines and transformers. One of the main advantages of this model is that it can be extended in order to account for new elements in the structure without affecting its basic configuration. Therefore, in this contribution, the TEN in [14] is extended in order to account for a ground plane backing the printed FSS. As explained in [14], the aid of full-wave tools is needed in order to extract some of the TEN key parameters. However, a very reduced number of simulations is required, in contrast to previous approaches. In addition, the present model can deal with any electrical size of the patches and polarization of impinging plane waves, and it explicitly considers the dependence with the angle of incidence and the characteristics of the dielectric slab. As the employed approach assumes that the current profile on the patch does not change significantly with frequency, scatterers with more complex geometries can also be considered as long as they are single resonant.

## II. DERIVATION OF THE CIRCUIT MODEL

In this section, a simple model is presented to characterize the diffraction at an array of patches printed on a grounded dielectric slab. The geometry of the array unit cell is depicted

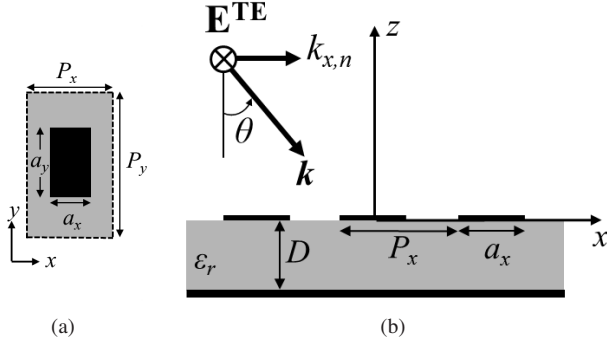

Fig. 1. (a) Patch array unit cell. (b) 2-D sketch of patch array printed on metal-backed dielectric slab. The obliquely incident field is TE-polarized, and impinges in the  $xz$  plane.

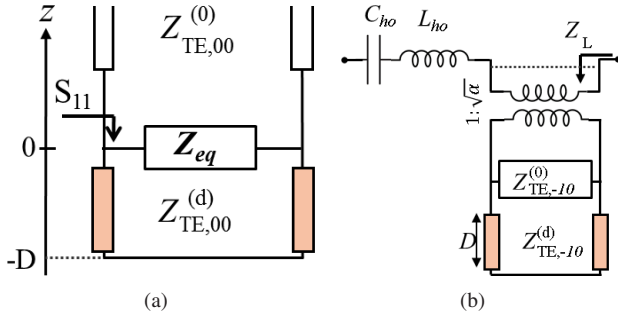

Fig. 2. (a) Transverse equivalent circuit to model Fig. 1. (b) Equivalent impedance of the discontinuity for Fig. 2(a) ( $Z_{eq}$ ).

in Fig. 1(a), whereas Fig. 1(b) shows a 2-D scheme of the compound structure illuminated by an oblique TE-polarized plane wave. In order to characterize this scenario we propose the transverse equivalent circuit (TEN) of Fig. 2(a). This TEN is built following the approach presented by some of the authors in [14]. Thus, the main concepts of the approach will be next briefly summarized due to the lack of space. Basically, the periodicity of the array allows us to express the original scenario as the equivalent problem of a discontinuity in a rectangular waveguide of dimensions  $P_x \times P_y$ . The incident plane wave is considered as the TE zero-th order Floquet harmonic of the array ( $TE_{00}$ ), and fundamental mode of the waveguide. Due to the polarization of the impinging wave, the equivalent waveguide is formed by two perfect electric walls parallel to the  $xz$ -plane, and two Floquet walls parallel to the  $yz$ -plane. When the impinging wave reaches the discontinuity at  $z = 0$  (the metallic patch), it excites all the higher-order harmonics supported by the array. This interaction is modeled by the impedance  $Z_{eq}$  detailed in Fig. 2(b). In particular, the excitation of all the high-order TM harmonics is accounted by the the lumped capacitance  $C_{ho}$ , whereas  $L_{ho}$  accounts for the of all the high-order TE harmonics apart from the one with lowest cutoff frequency (the  $TE_{-10}$  [14]). This last harmonic is modeled explicitly by  $Z_L$ , which corresponds to the input impedance seen by the  $TE_{-10}$  mode at both sides of the discontinuity. The transformer of ratio  $\alpha$  accounts for

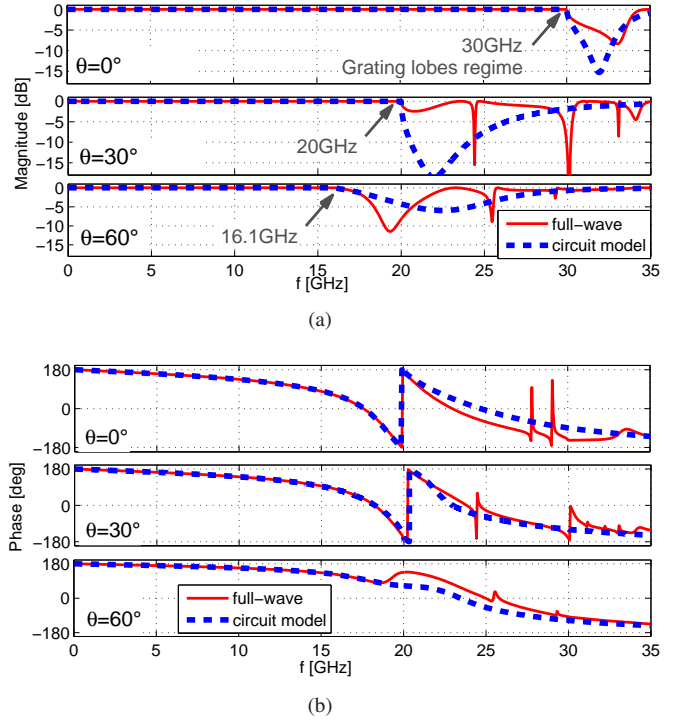

Fig. 3. Reflection coefficient under various angles of incidence for the structure of Fig. 1 with  $\epsilon_r = 4.5$ ,  $d = 1.5$  mm,  $P_x = P_y = 10$  mm,  $w_x = 8.75$  mm and  $w_y = 0.5$  mm.

the degree of excitation of this last harmonic. The value of the the two lumped elements  $C_{ho}$  and  $L_{ho}$ , together with the ratio  $\alpha$ , can be computed from three numerical values of the reflection coefficient provided by a few full-wave simulator.

The main novelty of this contribution with respect to [14] resides in the incorporation of the metallic sheet that is backing the printed array at  $z = -D$ . This extension has been done straightforward just by short-circuiting the end of the transmission-line sections that account for the dielectric slab. The interaction between the excited harmonics in the array and the ground plane is accurately modeled in this simple way thanks to the topology of the circuit model.

Although the proposed approach is very efficient from a numerical point of view, its major strength lies in its capability to provide a convenient frame to study the problem. The simplicity of the equivalent circuits makes it possible to accurately predict the qualitative behavior of the structures, and also to estimate the potential effects of changes in the geometry and characteristics of the repeated element of the periodic surface.

### III. RESULTS

The accuracy of the previous simple model is here validated by means of some illustrative examples. The equivalent circuit results are compared with full-wave simulations based on Method of Moments (MoM). Fig. 3 shows the magnitude and phase of the reflection coefficient of a HIS under various

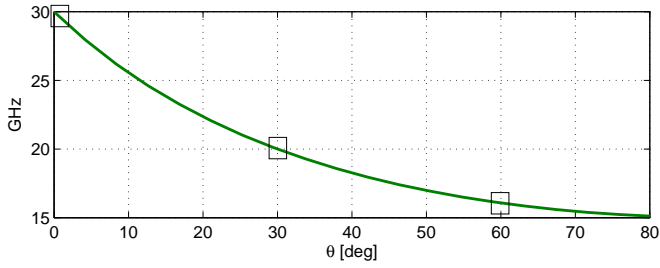

Fig. 4. Onset of the first higher order harmonic ( $TE_{-10}$ ) as a function of the angle of incidence at a periodic grating with  $P_x = P_y = 10$  mm (which sets the beginning of the grating lobes regime in Fig. 3).

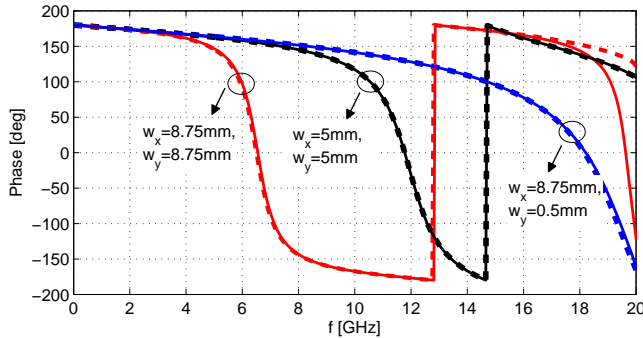

Fig. 5. Reflection coefficient phase under  $30^\circ$  incidence for the structure of Fig. 1 ( $\epsilon_r = 4.5$ ,  $d = 1.5$  mm and  $P_x = P_y = 10$  mm). Solid lines: MoM simulations; dashed lines: circuit model.

angles of incidence. Here, the circuit model accurately predicts the response of the structure below the appearance of grating lobes (GL). The onset of the GL regime can easily be identified in Fig. 3(a) and it corresponds to the frequency where  $|S_{11}|$  is no longer equal to one. At that point, the  $TE_{-10}$  harmonic starts propagating, carrying away energy from the impinging wave. The cutoff frequency of this harmonic has been obtained for this example and plotted in Fig. 4. It can be checked out that the theoretical values predicted in Fig. 4 exactly coincide with the launch of the GL regime in Fig. 3(a).

The validity of the method does not depend on the geometry of the patch, and it is proven by the results of Fig. 5. Lossy substrates can be also characterized just by considering their complex dielectric constant in the model. This case is specially interesting for practical purposes, as it allows to analyze the reflection losses of the structure. In addition, the physical insight of the model allows to identify the main causes of this losses. The results plotted in Fig. 6 prove that the circuit model accurately predicts the reflection amplitude reduction below the GL regime due to the losses, even when the substrate is very thin. The thickness of the substrate becomes an important constraint for some models based on effective permittivity approximations [12].

Finally, it should be highlighted that this simple model can be easily extended in order to increase its bandwidth. The previous results were obtained accounting explicitly for

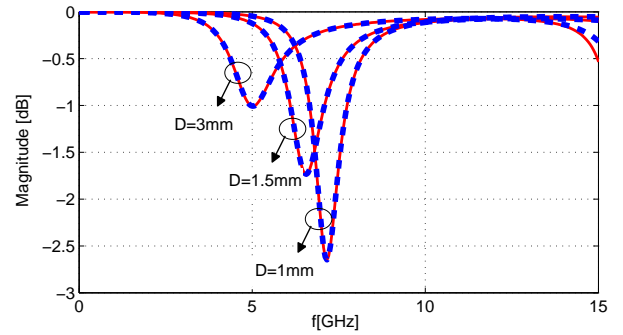

Fig. 6. Reflection coefficient magnitude under normal incidence for the structure of Fig. 1 ( $\epsilon_r = 4.5 - j0.088$ ,  $P_x = P_y = 10$  mm and  $w_x = w_y = 8.75$  mm). Solid lines: MoM simulations; dashed lines: circuit model.

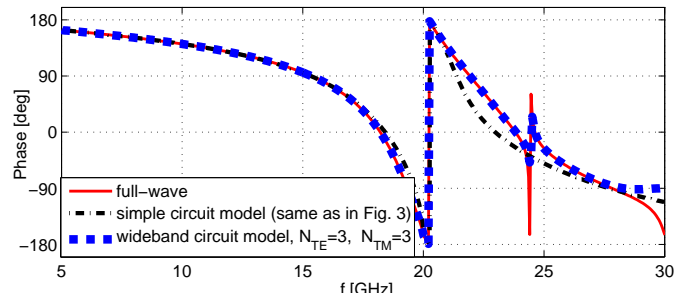

Fig. 7. Reflection coefficient phase under  $30^\circ$  incidence for the structure of Fig. 1 ( $\epsilon_r = 4.5$ ,  $P_x = P_y = 10$  mm,  $w_x = 8.75$  mm and  $w_y = 0.5$  mm).

the frequency behavior of just one higher order harmonic, the  $TE_{-10}$  one. However, accounting for more higher order harmonics, the HIS response can be reproduced at higher frequencies. Note that the individual characterization of each harmonic adds a new unknown to the circuit model (its associated excitation coefficient), and therefore, one more full-wave simulation is needed. As an example, the  $\theta = 30^\circ$  results in Fig. 3(b) are improved in Fig. 7 by considering the frequency behavior of the first three higher order TE and TM harmonics ( $N_{TE} = N_{TM} = 3$ , following the nomenclature in [14]).

## CONCLUSIONS

A very simple circuit model is here proposed to characterize the incidence of a TE plane-wave at a patch array printed on a grounded dielectric slab. The guidelines given in [14] are followed in order to build the model. Complex electromagnetic interactions taking place in the structure are accounted for, thus allowing to predict the response of the structure in a wide frequency range. The model can account for lossy dielectrics and patches of different size. TM incidence could be also modeled applying the same following rationale.

So far, the circuit models proposed by the authors have been employed to make plane-wave diffraction analysis of periodic structures, the so-called *study of reflection* [11]. However, these models could also be used to perform *study of dispersion*, obtaining the modal solutions of the structure, which is currently under investigation. Aperiodic structures such as

reflectarrays or inhomogeneous metasurfaces could also be synthesized with this technique by making local periodicity assumptions. In addition, due to its capability to seize the underlying physics of the structure, the proposed circuits could also be applied to model devices at higher frequencies. For example, these artificial surfaces could be designed at teraherzs assuming that metals are good conductors in this frequency range.

#### ACKNOWLEDGMENT

This work was supported by the Spanish Ministerio de Ciencia e Innovación and European Union FEDER funds under Project TEC2010 – 16948.

#### REFERENCES

- [1] D. F. Sievenpiper, L. Zhang, R. F. J. Broas, N. G. Alexopoulos and E. Yablonovich, "High-impedance electromagnetic surfaces with a forbidden frequency band," *IEEE Trans. Microwave Theory Techniques*, vol. 47, pp. 2059-2074, 1999.
- [2] B. Munk, *Frequency Selective Surfaces: Theory and Design*, Edt. John Wiley and Sons, 2000.
- [3] S. Fan, P. Villeneuve and J. Joannopoulos, "Large omnidirectional band gaps in metallodielectric photonic crystals," *Phys. Rev. B.*, vol. 56, pp. 11245-11251, 1996.
- [4] D. M. Pozar, S.D. Targonski and H.D. Syrigos, "Design of millimeter wave microstrip reflectarrays," *IEEE Trans. Antennas Propagat.*, vol. 45, no. 2, pp. 287-296, Feb 1997
- [5] A.A. Oliner and Hessel, "Guided waves on sinusoidally-modulated reactance surfaces," *IRE Trans. Antennas Propagat.*, vol. 7, no. 5, pp. 201-208, December 1959
- [6] M. Garcia-Vigueras, P. DeLara-Guarch, J. L. Gomez-Tornero, R. Guzman-Quiros and G. Goussetis, "Efficiently illuminated broadside-directed 1D and 2D tapered Fabry-Perot leaky-wave antennas," *Proc. 6th European Conference on Antennas Propagat., EuCAP*, pp. 247-251, March 2012
- [7] D. Sievenpiper, J. Colburn, B. Fong, J. Ottusch and J. Visher, "Holographic artificial impedance surfaces for conformal antennas," *IEEE APS/URSI Symposium*, Washington, DC, July 2005.
- [8] P.S. Kildal, A.A. Kishk and S. Maci, "Special Issue on Artificial Magnetic Conductors, Soft/Hard Surfaces, and Other Complex Surfaces," *IEEE Trans. Antennas Propagat.*, vol. 53, no. 1, pp. 2-7, Jan 2005
- [9] T. W. Ebbesen, H. J. Lezec, H. F. Ghaemi, T. Thio, and P. A. Wolff, "Extraordinary optical transmission through sub-wavelength hole arrays," *Nature*, vol. 391, pp. 667-669, Feb. 1998.
- [10] O. Luukkonen, C. Simovski, G. Granet, G. Goussetis, D. Lioubtchenko, A. V. Räisänen, and S. A. Tretyakov, "Simple and accurate analytical model of planar grids and high-impedance surfaces comprising metal strips or patches," *IEEE Trans. Antennas Propagat.*, vol. 56, no. 6, pp. 1624-1632, June 2008.
- [11] S. Maci, M. Caiazzo, A. Cucini, and M. Casaletti, "A pole-zero matching method for EBG surfaces composed of a dipole FSS printed on a grounded dielectric slab," *IEEE Trans. Antennas Propag.*, vol. 53, no. 1, pp. 70-81, Jan. 2005.
- [12] F. Costa, A. Monarchio and G. Manara "Efficient Analysis of Frequency-Selective Surfaces by a Simple Equivalent-Circuit Model," *IEEE Trans. Antennas Propagat. Magazine*, vol. 54, no. 4, pp. 35-48, Aug. 2012.
- [13] F. Medina, F. Mesa and R. Marqués, "Extraordinary transmission through arrays of electrically small holes from a circuit theory perspective," *IEEE Trans. Microw. Theory Tech.*, vol. 56, no. 12, pp. 3108-3120, Dec. 2008.
- [14] M. García-Vigueras, F. Mesa, F. Medina, R. Rodríguez-Berral, J. L. Gómez-Tornero, "Simplified circuit model for metallic arrays of patches sandwiched between dielectric slabs under arbitrary incidence," *IEEE Trans. Antennas Propagat.*, vol. 60, no. 10, pp. 4637-4649, Oct. 2012.