

A Tablet MIMO Antenna with a Wave-Trap Slot for LTE/WiMAX Applications

Wen-Hsiu Hsu, Chung-Hsuan Wen, Shan-Cheng Pan and Huan-Yu Jheng

Department of Computer and Communication, Shu-Te University NO. 59, Hengshand Rd., Yanchao Dist., Kaohsiung City, 82445 Taiwan

Abstract- A tablet MIMO antenna with a wave-trap for LTE/WiMAX applications is presented. To improve the isolation between the two radiating elements of MIMO antenna, added a wave-trap slot on the ground plane. The isolation is improved by approximately 20 dB at the LTE700 frequency. The design MIMO antenna satisfies a 6 dB return loss requirement and the obtained envelope correlation coefficient (ECC) is lower than 0.1 from the LTE (700) and LTE/WiMax (2300-2700). The method can be accurate operation at LTE/WiMax communication system.

Index Terms — MIMO, LTE, WiMax, coupled-fed, antennas, ECC

I. INTRODUCTION

Current wireless communication systems require higher bit rate transmission to support various multimedia services. A multi-input multi-output (MIMO) system has been regarded as a promising solution, since it can increase the channel capacity without sacrificing spectrum efficiency or consuming additional transmitted power [1]. In MIMO system, two or more antennas are used on both the transmitter and receiver sides. A critical point is to arrange compact antenna elements without impairing antenna performance and system requirement within a compact space. To do that, low mutual coupling or high isolation between adjacent antennas is a key factor. However, the antenna elements are strongly coupled with each other as well as with the ground plane, because they share the common surface current. Several techniques have been introduced to improve the isolation characteristic, such as employing protruded T-shaped ground plane [2], protruded ring strip ground plane [3], protruded ground plane and a spiral open slot [4], protruded a wave-trap ground plane [5], quarter wavelength slot on the ground plane [6], and notches on the ground plane as resonator [7]. These structures provide conspicuous decoupling effect, but suffer from complicated structures and large structural area. They cannot be applied for LTE mobile application with restricted space available for the antennas.

In this paper, we propose a MIMO antenna with application. To improve the isolation characteristic at the LTE700, a wave-trap slot is added on the ground plane.

II. ANTENNA DESIGN

The configuration of the proposed MIMO antenna is shown in Figure.1. The proposed MIMO antenna include two radiating elements, the wave-trap slot on the ground plane, and FR4 substrate ($\epsilon_r = 4.4$) with thickness of 0.8 mm.

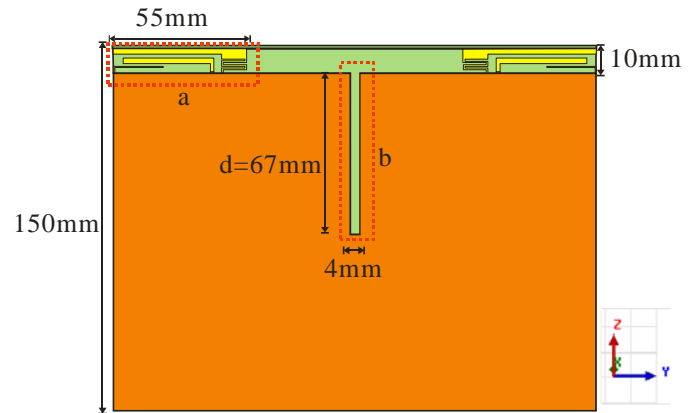

Figure.1 Tablet MIMO system for LTE/WiMax applications.

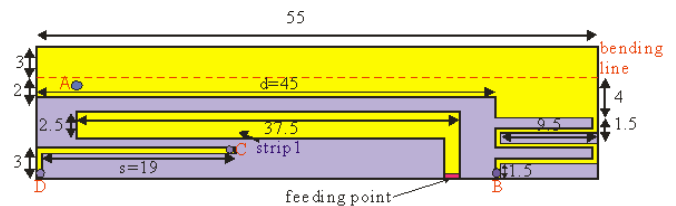

Figure.2 Antenna body.

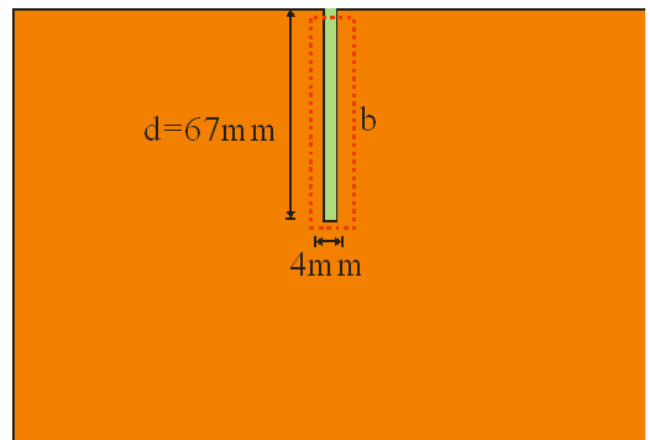

Figure.3 The wave-trap slot.

The two radiating elements of the MIMO antenna were symmetrically placed with respect to the center and were located near the corners of the top edge of the ground plane as shown in Figure.1. The antenna consists of a wave-trap slot on the ground plane. Figure.2 shows the geometry of the proposed LTE/WiMax coupled-fed loop antenna. The loop antenna comprises an inverted L-shaped radiating feed and dual coupled shorting-strip connects to display ground. One is for lower

band LTE (700) and the other is for higher bands (LTE2300~2700,WiMAX). The antenna is mainly printed on a 0.8mm thick FR4 substrate of dimension(10 x 55 x 3 mm³), relative permittivity 4.4, and loss tangent 0.024.

On the top edge of the FR4 substrate (cleance area), the printed metal pattern mainly includes the inverted L-shape radiating element, the main section and banding section. The banding section of the radiation element has a size of 3 x 55 mm², which is connected orthogonally to the printed pattern main section on the FR4 substrate. The main section has three parts , the first part is the coupled-fed (length 37.5 mm and width 2.5 mm) connect to the feeding point and second is lower band strip which is connect banding section and meandering line, the coupling gap to the inverted L radiating feed is 1.5 mm. From the major part of the coupled shorted strip, this has a length of about 79.5 mm (AB) which can operate at its quarter-wavelength mode as the lower resonant mode, which occurs at about 735 MHz in the proposed design. The last one is another coupled shorted strip, which has a length of about 22 mm (CD) and is coupled fed through the coupling section (length s $\frac{1}{4}$ 15.5 mm) and the coupling gap (g $\frac{1}{4}$ 1 mm) by the inverted L radiating feed. With the coupling feed, the antenna can operate at its quarter-wavelength mode which occurs at about 2300 MHz in the proposed design

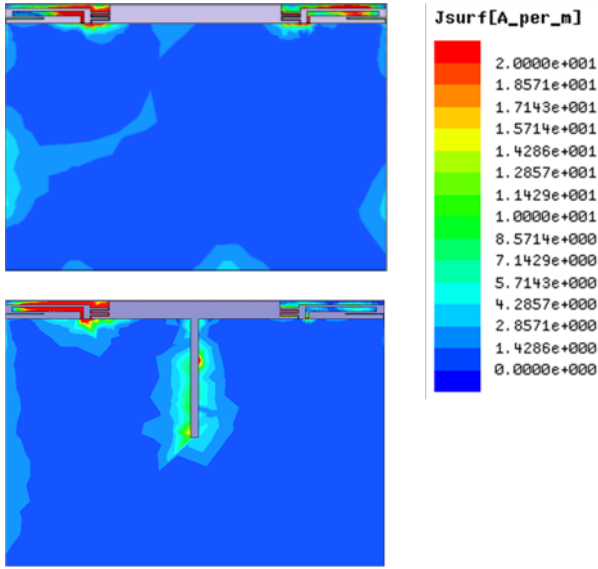

Figure.4 The time-averaged current distribution and ground plane at 750 MHz.
(a) without the wave-trap slot (b) with the wave-trap slot.

The configuration of the proposed a wave-trap slot on the ground plane is shown in Figure.3. To improve the isolation between two symmetrical radiators, a slot on the ground plane is used. The wave-trap slot can hinder the current of the antenna, so that the antenna current interference becomes small and increasing the isolation. In designing the wave-trap slot, a wave-trap slot on the ground plane of the FR4 substrate is symmetrically printed with respect to the center of the ground which size is 67 x 4 mm².

To investigate the effect on the isolation characteristic, the current distributions at 750 MHz with and without the wave-trap slot on the ground plane are shown in Figure.4. When the wave-trap slot on the ground plane was existed, a substantial induced current was induced at the other element. After the wave-trap slot on the ground plane was added, the induced current on the non-excited element become very weak.

III. EXPERIMENTAL RESULTS

Figure 5 shows the measured and simulated S-parameter of the proposed antenna. The simulated are obtained using the three-dimensional full-wave electromagnetic field simulation HFSS [8].The measured results are very similar to simulated ones. The fabricated MIMO antenna has an impedance bandwidth of the return loss < 6 dB over the whole LTE 700, LTE/WiMax (2300-2700) and the isolation is higher than 20 dB at the center frequency.

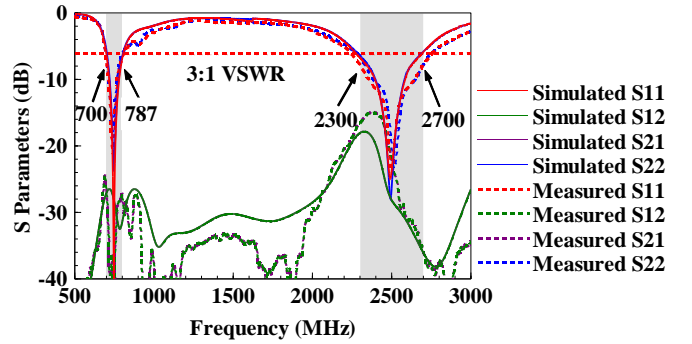

Figure.5 Measured and simulated S-parameter of the proposed antenna.

Antenna correlation calculation procedure is provided by appropriate methods of analysis [9-15]. The method of calculating envelope correlation of elements in each antenna array configuration is based on a fundamental Equation (1) that requires 3-dimensional radiation pattern considerations.

$$\rho_e = \frac{\left| \iint_{4\pi} \vec{F}_1(\theta, \phi) \bullet \vec{F}_2^*(\theta, \phi) d\Omega \right|^2}{\iint_{4\pi} \left| \vec{F}_1(\theta, \phi) \right|^2 d\Omega \iint_{4\pi} \left| \vec{F}_2(\theta, \phi) \right|^2 d\Omega}$$

Equation (1)

The parameter is the field radiation pattern of the antenna system when only the port 1 is excited and the port 2 is terminated to 50 Ω load. The symbol “ \bullet ” also denotes the Hermitian product [9] [15].

Recent research activities have shown that the envelope correlation can be well defined by a simple closed-form equation that relates the scattering parameters of the elements in an antenna array configuration. Especially, in case of a multipath indoor environment with a uniform distribution of

Equation (2) is proved to be a good approximation [9]. For two antenna elements this equation using the scattering parameters becomes:

$$\rho_e = \frac{|S_{11}^* S_{12} + S_{21}^* S_{22}|^2}{(1 - |S_{11}|^2 - |S_{21}|^2)(1 - |S_{22}|^2 - |S_{12}|^2)}$$

Equation (2)

It is obvious that radiation pattern in Equation (1) makes the calculation more complicated than the envelope correlation calculations based on in Equation (2). The practical advantage of the third method that is based on second equation is that not only is quite simple to use it experimentally, but also provides sufficiently accurate results in many experimental environments such as in-door environments with rich multipath propagation performance.

Figure.6 show the ECC of two antennas, the obtained ECC is lower than 0.1 from measured S-parameters and is sufficient for MIMO applications.

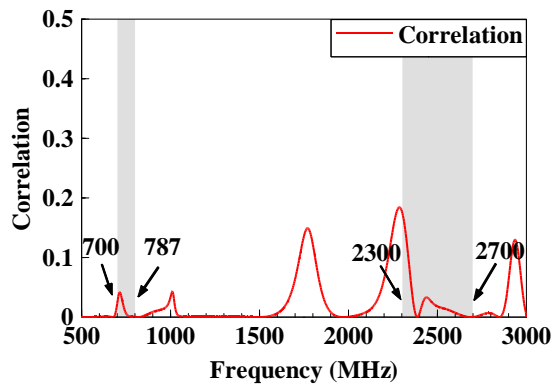

Figure.6 ECC of two antennas given by the obtained from measure S-parameters.

Figure.7 shows the measured antenna efficiency of the proposed antenna. The measurement is conducted in a far-field anechoic chamber, and the measured antenna efficiency includes the mismatching loss. The antenna efficiency is about 80–60% and 75–40% in the antenna’s lower and upper bands, respectively, which are acceptable for practical applications.

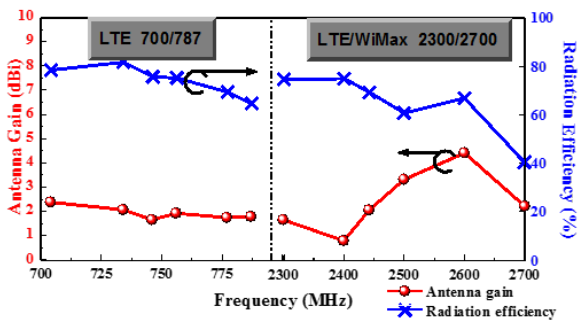

Figure.7 Measured antenna efficiency (mismatching loss included) of the proposed antenna

The measured 3D-radiation pattern of fabricated MIMO antenna was measured in the ETS chamber[16] and the 746, 2500 results are presented in Figure.8.

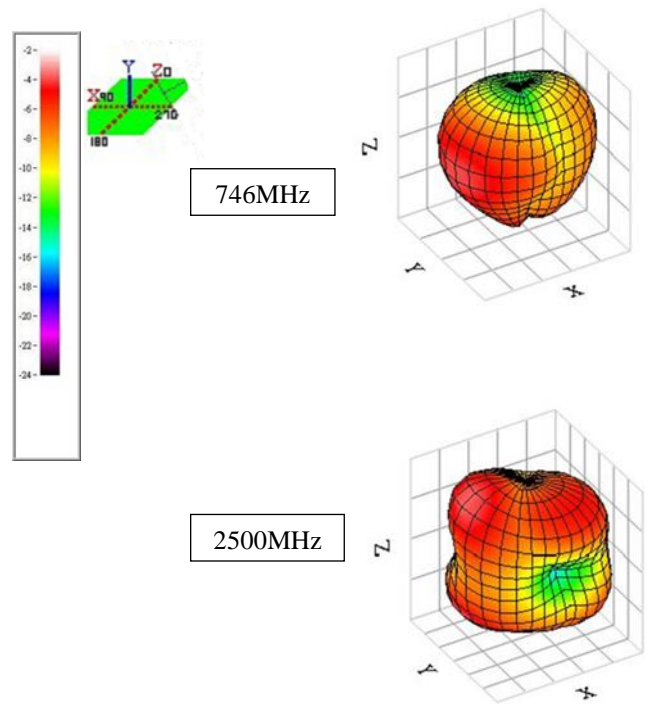

Figure.8 Measured 3D radiation patterns of the proposed antenna.

Figure.9 shows the S-parameter characteristics for various lengths (d) of wave-trap slot. Choosing the proper dimension of the wave-trap slot is very important because the isolation is strongly dependent on the length of the wave-trap slot. When the length d is increased, the improved isolation frequency band shifts to a lower frequency band. The optimized value of d is 67 mm.

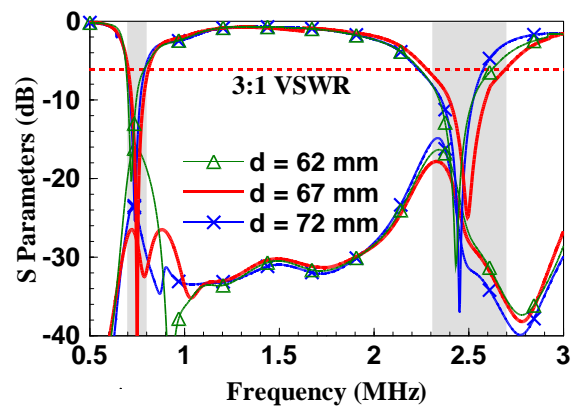

Figure.9 Simulated S-parameters characteristics for the proposed MIMO antenna for various values of

“d”

CONCLUSION

In this paper, MIMO antennas with improved isolation using a wave trap slot on the ground plane for LTE mobile application are proposed. The wave-trap slot is added on the ground plane to improve the isolation characteristic. The proposed MIMO antenna has a 6 dB return loss bandwidth and the isolation characteristic is higher than 11 dB over the whole LTE 700、LTE/WiMax (2300-2700). The obtained envelope correlation coefficient(ECC) was less than 0.4. Therefore, the proposed a wave-trap slot on the ground plane, can be a good candidate for MIMO antenna system requiring high isolation characteristic.

REFERENCES

- [1] Gesbert, D., Shafi, M., Shiu, D.S., Smith, P., and Naguib, A., "From theory to practice : an overview of MIMO space-time coded wireless systems" IEEE Journal on Selected Areas in Communication., vol. 21, no.3, pp. 281-302, Mar. 2003.
- [2] T.-Y. Wu, S.-T. Fang, and K.-L. Wong. "Printed diversity monopole antenna for WLAN operation", Electronics Letters., vol. 38, no. 25, pp. 1625-1626, Dec 2002.
- [3] K.L. Wong, P.W. Lin and H.J. Hsu, "Decoupled WWAN/LTE antennas with an isolation ring strip embedded therebetween for smartphone application," Microwave Opt. Technol. Lett., Vol. 55, pp. 1470-1476, Jul. 2013.
- [4] K.L. Wong, H.J. Jiang and Y.C. Kao, "High-isolation 2.4/5.2/5.8 GHz WLAN MIMO antenna array for laptop computer application," Microwave Opt. Technol. Lett., Vol. 55, pp. 382-387, Feb. 2013.
- [5] T.W. Kang and K.L. Wong, "Isolation improvement of 2.4/5.2/5.8 GHz WLAN internal laptop computer antennas using dual-band strip resonators aware-trap," Microwave Opt. Technol. Lett., Vol. 51, pp. 58-64, Jan. 2010.
- [6] Y. Ge, K.P. Esselle, and T.S. Bird, "Compact diversity antenna for wireless devices", Electronics Letters., vol. 41, no. 2, pp. 52-53, Jan 2005.
- [7] K.-J. Kim and K.-H. Ahn, "The high isolation dual-band inverted F antenna diversity system with the small N-section resonators on the ground plane", Microwave and Optical Technology Letters., vol. 49, no. 3, pp. 731-734, March 2007.
- [8] Available at: <http://www.ansys.com/products/hf/hfss/>, ANSYS HFSS, Ansoft Corp., Pittsburg, PA 15219
- [9] R.G. Vaughan, "Signals in Mobile Communications," IEEE Transactions on Vehicular Technology, Vol. 35, 1986, pp. 133-145.
- [10] G. Lebrun, S. Spiteri and M. Faulkner, "MIMO Complexity Reduction through Antenna Selection," Proceedings on Australian Telecommun Cooperative Research Center, ANNAC'03, Vol. 5, 2003.
- [11] S. Jacobs and C. P. Bean, "Fine Particles, Thin Films and Exchange Anisotropy," In Magnetism, G. T. Rado and H. Suhl, Eds., Academic, New York, Vol. 3, 1963, pp. 271-350.
- [12] R. H. Clarke, "A Statistical Theory of Mobile Reception," Bell System Technology Journal, 1968, pp. 957- 1000. R. Nicole, "Title of Paper with Only First Word Capitalized," Journal Name Standard Abbreviations, in Press.
- [13] K. Boyle, "Radiation Pattern and Correlation of Closely Spaced Linear Antennas," IEEE Transactions on Antennas Propagation, Vol. 50, 2002, pp. 1162-1165.
- [14] H. T. Hui, W. T. Ouyang and K. B. Toh, "Signals Correlation between Two Normal-Mode Helical Antennas for Diversity Reception in a Multipath Environment," IEEE Transactions on Antennas Propagation, 2004, pp. 572-577.
- [15] J. Blanch, J. Romeu and I. Cordella, "Exact Representation of Antenna System Diversity Performance from Input Parameter Description," Electronics Letters, Vol. 39, 2003, pp. 705-707.
- [16] Available at: <http://www.ets-lindgren.com/chambers>, ETS Chamber.