

# Analysis of Near-Field Power Transfer of Multi-Antenna Using Multiport Scattering Parameters

Mingda Wu<sup>1</sup>, Qiang Chen<sup>1</sup>, Qiaowei Yuan<sup>2</sup>

Department of Communications Engineering, School of Engineering, Tohoku University<sup>1</sup>

Sendai National College of Technology<sup>2</sup>

**Abstract**-Power transfer efficiency (PTE) of wireless power transfer (WPT) using near-field coupling of multi-antenna is numerically analyzed by using the scattering parameters after modeling the whole multi-antenna WPT system as a multi-port network. Because the multi-port scattering parameters can easily be measured by using a vector network analyzer and calculated by a full-wave numerical analysis, it is convenient to investigate the relationship between the PTE and the geometry of the multi-antenna WPT system, such as the relative position of the transmitting antenna and the receiving antennas, the geometry of antennas and copper loss in the antennas.

## I. INTRODUCTION

Wireless power transfer (WPT) attracts great attention because of its potential application to charge laptop computers, mobile phones, portable audio players and other electronic devices without cords [1]-[6]. Researches even showed the application prospect of charging motor vehicles wirelessly. It was also experimentally demonstrated that very efficient power transmission can be achieved by using the strongly-coupled resonance method [1]. It was shown that the strongly-coupled resonance method can transmit energy for a longer distance than the preciously used near-field induction method [2]. Again, the strongly-coupled resonance method was shown to be more efficient than the far-field radiation method [3], where most energy is wasted due to the transmission loss [4]-[5]. Because of the existence of the electromagnetic hazard on human body and the multi-user situation, a more efficient multi-user WPT system is urgently concerned.

The power transfer efficiency (PTE) is one of the most important parameters to evaluate the performance of a WPT system. In order to develop a WPT system with a high PTE, it is required to have an efficient method to calculate the PTE by analyzing electromagnetically the WPT system. If the transmitting antenna and receiving antenna are described as a two-port network circuit, the power transfer between the transmitting antenna and receiving antenna in the WPT system can be indicated by using the scattering parameters of the network circuit and further the PTE can be calculated by using the scattering parameters. Because the scattering parameters of a WPT system can be measured by a vector

network analyzer and calculated by a full-wave numerical analysis, the scattering parameters are a very efficient tool in analyzing and designing the antennas and RF modules for a WPT system.

A fundamental study focused on the PTE of a WPT system composed of dipole and loop antennas as the transmitting and receiving antennas was carried out by the present authors, where a two-port scattering parameters calculated by the method of moments (MoM) were used to analyze the system and it was found the largest PTE was obtained when the near-field coupled antennas of both transmitting and receiving sides were conjugate-matched with the impedance of the transmitting and receiving circuits, respectively [6]. The optimum load for maximum transfer efficiency of a practical WPT system was derived when the WPT system was equivalent to a 2-port lossy network [7] also by the present authors.

This paper shows the result of the continued study published in [8], where multi-port scattering parameters are applied to the analysis of multi-antenna in a WPT system corresponding to multi-user situations. The expression of PTE is defined in term of the multi-port scattering parameters. Some numerical simulations are shown to demonstrate it is easy to evaluate the PTE for various models of the antenna geometries, locations of transmitting and receiving antennas in a multi-user WPT system by using the multi-port scattering parameters.

## II. ANALYSIS OF MULTI-PORT NETWORK FOR MULTI-USER WPT SYSTEM

A generalized 4-port network is shown in Fig. 1, which represent a 4-antenna WPT system with one transmitting antenna and three receiving antennas. 4 ports are named A, B, C and D, respectively. By using MoM, 4×4 scattering parameters of this 4-port network can be got. The reflection coefficients at every port are labeled in the Fig. 1, and the reference impedance is  $Z_0=50 \Omega$ .  $P_A$  is the power available from the source,  $P_B$ ,  $P_C$  and  $P_D$  is the power delivered to each load. The  $a_1$ ,  $a_2$ ,  $a_3$  and  $a_4$  in the Fig. 1 are the incident waves of port A, B, C and D, respectively. Besides,  $b_1$ ,  $b_2$ ,  $b_3$  and  $b_4$  are the reflected waves of each load. Therefore, if

these 4 ports are impedance matched simultaneously, four equations can be obtained:

$$\Gamma_A = \Gamma_1^*, \Gamma_B = \Gamma_2^*, \Gamma_C = \Gamma_3^*, \Gamma_D = \Gamma_4^* \quad (1)$$

Fig. 2 is the signal flow graph of this 4-port network. From the Mason's gain formula and the definition of reflection coefficient, follow equations can be obtained:

$$\Gamma_1 = \frac{b_1}{a_1} = f_1(\Gamma_A, \Gamma_B, \Gamma_C, \Gamma_D) = \Gamma_A^* \quad (2)$$

$$\Gamma_2 = \frac{b_2}{a_2} = f_2(\Gamma_A, \Gamma_B, \Gamma_C, \Gamma_D) = \Gamma_B^*$$

$$\Gamma_3 = \frac{b_3}{a_3} = f_3(\Gamma_A, \Gamma_B, \Gamma_C, \Gamma_D) = \Gamma_C^*$$

$$\Gamma_4 = \frac{b_4}{a_4} = f_4(\Gamma_A, \Gamma_B, \Gamma_C, \Gamma_D) = \Gamma_D^*$$

In equation (2),  $\Gamma_1, \Gamma_2, \Gamma_3$  and  $\Gamma_4$  are expressed by functions of  $\Gamma_A, \Gamma_B, \Gamma_C$  and  $\Gamma_D$ . Solving equation (2),  $\Gamma_A, \Gamma_B, \Gamma_C$  and  $\Gamma_D$  can be figured out. From the relationship between the reflection coefficient and the impedance load below,

$$Z_L = \frac{1 + \Gamma_L}{1 - \Gamma_L} \quad (3)$$

the optimal load impedance  $Z_A, Z_B, Z_C$  and  $Z_D$  that make the 4-port network impedance matched can be figured out.

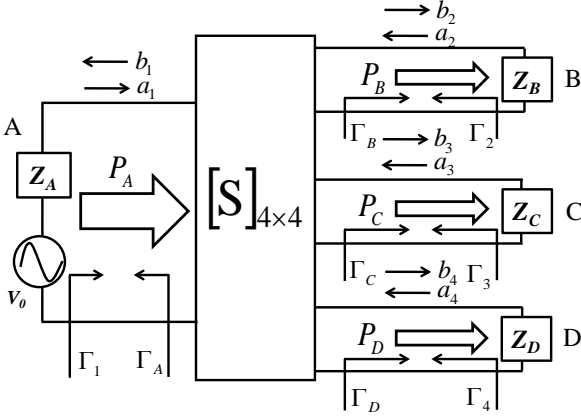

Fig. 1. 4-port network

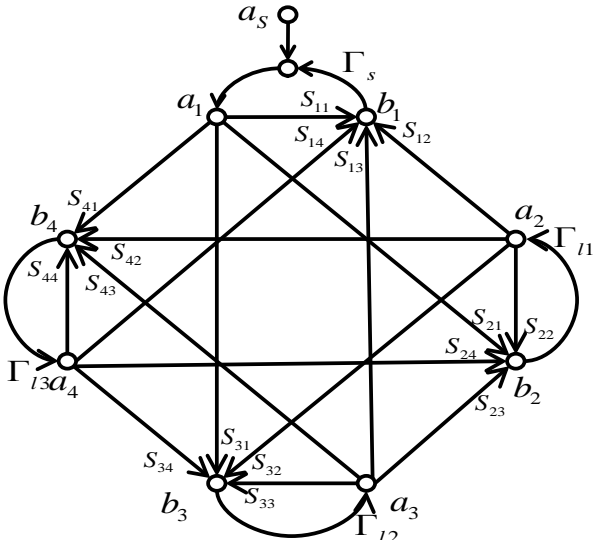

Fig. 2. Signal flow graph of 4-port network

Power flow at each port is expressed as:

$$P_A = (1 - |\Gamma_A|^2) \frac{|a_s|^2}{|1 - \Gamma_A \Gamma_A^*|^2} = \frac{|a_s|^2}{1 - |\Gamma_A|^2} \quad (4)$$

$$P_B = |b_2|^2 - |a_2|^2 = (1 - |\Gamma_B|^2) |b_2|^2$$

$$P_C = |b_3|^2 - |a_3|^2 = (1 - |\Gamma_C|^2) |b_3|^2$$

$$P_D = |b_4|^2 - |a_4|^2 = (1 - |\Gamma_D|^2) |b_4|^2$$

So the individual PTE to each load can be expressed as

$$\eta_B = \frac{P_B}{P_A} = \frac{(1 - |\Gamma_B|^2) |b_2|^2}{\frac{|a_s|^2}{1 - |\Gamma_A|^2}} = (1 - |\Gamma_A|^2) (1 - |\Gamma_B|^2) \left| \frac{b_2}{a_s} \right|^2 \quad (5)$$

$$\eta_C = \frac{P_C}{P_A} = \frac{(1 - |\Gamma_C|^2) |b_3|^2}{\frac{|a_s|^2}{1 - |\Gamma_A|^2}} = (1 - |\Gamma_A|^2) (1 - |\Gamma_C|^2) \left| \frac{b_3}{a_s} \right|^2$$

$$\eta_D = \frac{P_D}{P_A} = \frac{(1 - |\Gamma_D|^2) |b_4|^2}{\frac{|a_s|^2}{1 - |\Gamma_A|^2}} = (1 - |\Gamma_A|^2) (1 - |\Gamma_D|^2) \left| \frac{b_4}{a_s} \right|^2$$

$$\eta_t = \eta_B + \eta_C + \eta_D$$

In the equation (5),  $\eta_B, \eta_C, \eta_D$  are the individual PTE to the load  $Z_B, Z_C, Z_D$ , respectively. And  $\eta_t$  is the total PTE of this 4-port system. Using Mason's gain formula again, the ratios at the right part of the equation (5) can be expressed by functions of  $\Gamma_A, \Gamma_B, \Gamma_C$  and  $\Gamma_D$ :

$$\frac{b_2}{a_s} = f_5(\Gamma_A, \Gamma_B, \Gamma_C, \Gamma_D) \quad (6)$$

$$\frac{b_3}{a_s} = f_6(\Gamma_A, \Gamma_B, \Gamma_C, \Gamma_D)$$

$$\frac{b_4}{a_s} = f_7(\Gamma_A, \Gamma_B, \Gamma_C, \Gamma_D)$$

where,  $\Gamma_A, \Gamma_B, \Gamma_C, \Gamma_D$  can be calculated from equation (2). That is the whole process in calculating the PTE and optimal loads of an arbitrary 4-port network when knowing its scattering parameters.

### III. POWER TRANSFER EFFICIENCY OF MULTI-ANTENNA WPT

A WPT system composed of one transmitting antenna and three receiving antennas is shown in Fig. 3 as an analysis model for following numerical simulation. The transmitting and receiving antennas have the same antenna length  $l$  and conductivity  $\sigma$ . Transmitting and receiving antennas are all placed along the  $z$ -axis. Three receiving antennas are placed at a distance  $d$  from the transmitting antenna with an angle  $\theta = 120^\circ$ . The radius of the dipole antenna is 1 mm.

For comparison, a 2-antenna WPT model is built, show in Fig. 4. The antenna elements of this 2-antenna WPT system have same geometry with the antenna elements in Fig. 3. The distance between two dipole antennas is  $d$ . The calculation method of PTE for 2-antenna model under

impedance matching is introduced in the previous research by the present authors [6].

Fig. 5 is the frequency characteristic of PTE of this two model, when  $l = 30$  cm,  $d = 50$  cm,  $\sigma = \infty$ .

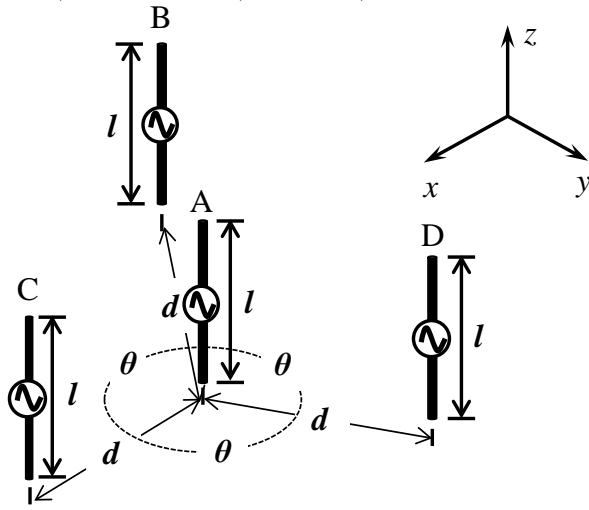

Fig. 3. Analysis model: WPT with one transmitting and three receiving dipole antennas

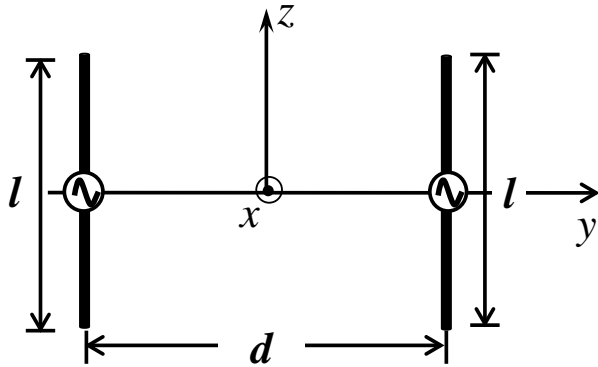

Fig. 4. 2-port WPT system for comparison

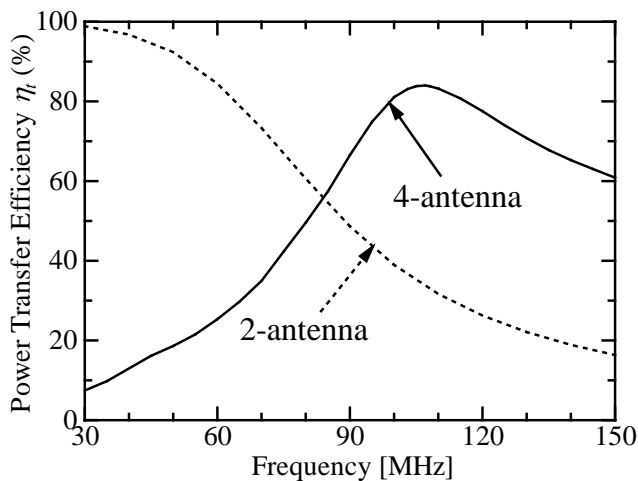

Fig. 5. Frequency characteristics of PTE of 4-port and 2-port

From Fig. 5 it is found that the total PTE  $\eta_t$  of 4-antenna model is increased till 107 MHz, and then is decreased when the frequency becomes higher than 107 MHz. The PTE of 2-antenna model decreases all along from 30 MHz to 150 MHz. Comparing the solid line and dot line in Fig. 5, it is found 2-antenna WPT system performs better than the 4-antenna WPT system in low frequency range, 30 MHz to 85 MHz in this case. However in the high frequency range, 85 MHz to 150 MHz in this case, 4-antenna model takes its advantage to 2-antenna model in terms of the PTE.

This result might be because when frequency gets lower, the wave length becomes longer. Therefore, antennas of this 4-antenna model are seen much closer to each other compared with wavelength. The combination of these 4 dipole antennas will radiate more like a single and large antenna. At last, large radiation loss cause the low PTE in low frequency range.

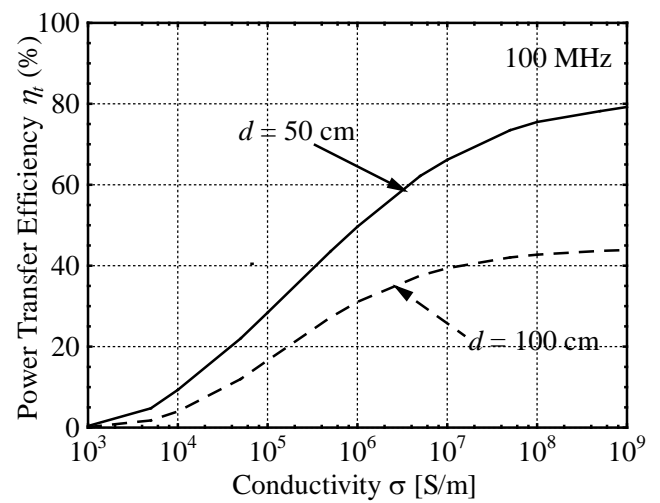

Fig. 6. PTE of 4-antenna model with changing antenna conductivity  $\sigma$

Another simulation analysis was conducted when the antenna conductivity  $\sigma$  of the 4-antenna model is changed where  $l = 30$  cm,  $d = 50$  or 100 cm and at frequency 100 MHz. The result is shown in Fig. 6.

From Fig. 6, it is found that the total PTE  $\eta_t$  gets larger with the increasing of conductivity  $\sigma$ . However, comparing the solid line and the dash line, it's found that in the high conductivity range ( $\sigma$  from  $10^8$  to  $10^9$  in this case), the solid line changes larger but the dash changes little. That means the PTE of the multi-antenna system with long distance between the transmitting antenna and the receiving antenna is not sensitive to the change of the antenna conductivity  $\sigma$ .

In the above numerical simulation, Discussions of 4-antenna WPT system with 3 uniformly spaced receiving antennas have been covered. We are interested in the situation where the antennas are not uniformly placed, for example, the model of 3 receiving antennas which have

different distance towards the transmitting antenna. In order to simplify the problem, we build a model shown in Fig. 7.

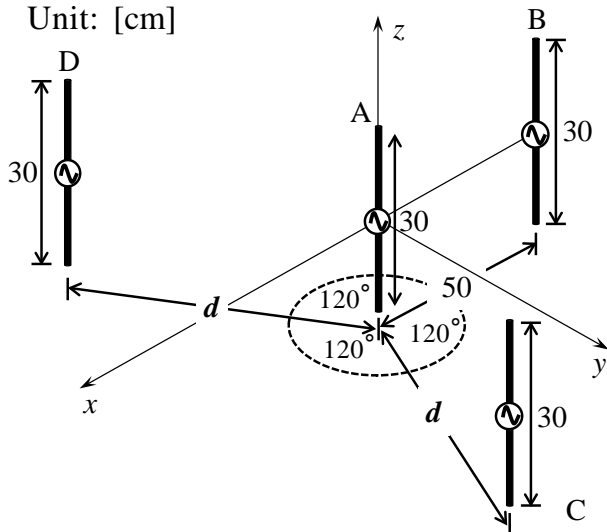

Fig. 7. Analysis model: WPT with three nonuniformly placed receiving antennas

In Fig. 7, dipole antenna A is the transmitting antenna, and dipole antenna B, C and D are the receiving antennas. 4 dipole antennas have same length of 30 cm, the same antenna radius 1 mm and the same PEC material. Antenna B is apart from antenna A with a distance of 50 cm. Antenna C and D are placed from A with a distance  $d$ .

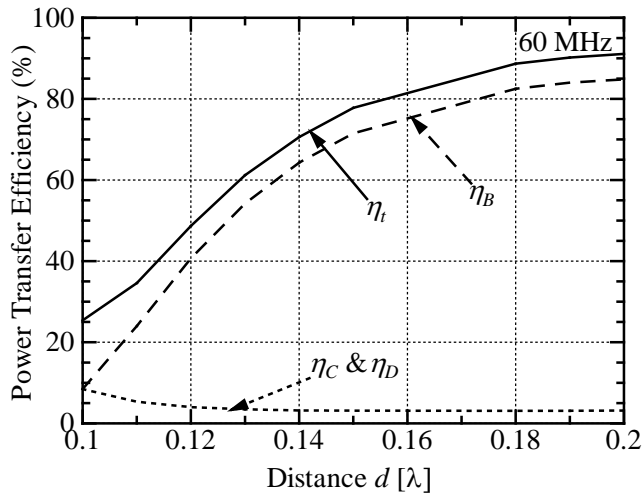

Fig. 8. Frequency characteristic of PTEs when change  $d$

When the frequency is 60 MHz, the distance  $d$  is changed from 50 cm ( $0.1\lambda$ ) to 100 cm ( $0.2\lambda$ ), in order to find out the relationship between PTE and distance between transmitting and receiving antennas. The result is shown in Fig. 8.

From Fig. 8, it is found when  $d$  changes from  $0.1\lambda$  to  $0.2\lambda$ , the PTE of antenna B gets larger and the PTEs of antenna C and antenna D get smaller. The total PTE of this 4-antenna system, which is the sum of  $\eta_B$ ,  $\eta_C$  and  $\eta_D$ , also become larger. This means a 4-antenna WPT system with uniformly

placed receiving antennas is not suitable to obtain the maximum PET.

#### IV. CONCLUSIONS

In this research, PTE of the impedance matched multi-antenna WPT system has been investigated corresponding to multi-antenna situations. It was shown that the total PTE of a multi-antenna system is small in low frequency range. Because the mutual coupling of antennas is stronger in low frequency range, and lead to more radiation loss. Also, it was shown the closer receiving antenna from the transmitting antenna, the more sensitively the PTE changes to the antenna conductivity. At last, it was found that in a multi-antenna WPT system, most of the power is absorbed by the nearest antenna and the uniformly distributed receiving antennas can result in a low PTE.

#### ACKNOWLEDGMENT

This research was partly supported by Adaptable & Seamless Technology Transfer Program through Target-driven R&D (A-STEP) of The Japan Science and Technology Agency (JST) This work was also partly supported by JSPS Grant-in-Aid for Scientific Research (C) of Grant Number 25420353.

#### REFERENCES

- [1] A. Kurs, A. Karakis, R. Moffatt, J. D. Joannopoulos, P. Fisher, and M. Soljacic, "Wireless Power Transfer via Strongly Coupled Magnetic Resonances," *Science*, vol. 317, no. 5834, pp. 83-86, July 2007.
- [2] J. Murakami, F. Sato, T. Watanabe, H. Matsuki, S. Kikuchi, K. Harakawai, and T. Satoh, "Consideration on Cordless Power Station - Contactless Power Transmission System," *IEEE Transactions on Magnetics*, vol. 32, no. 5, pp. 5017-5019, September 1996.
- [3] W. C. Brown, "The History of Power Transmission by Radio Waves," *IEEE Transactions on Microwave Theory and Techniques*, vol. 32, no. 9, pp. 1230-1242, September 1984.
- [4] H. Matsumoto, "Research on Solar Power Satellites and Microwave Power Transmission in Japan," *IEEE Microwave Magazine*, vol. 3, no. 4, pp. 36-45, December 2002.
- [5] C. T. Rodenbeck and K. Chang, "A Limitation on the Small-Scale Demonstration of Retrodirective Microwave Power Transmission from the Solar Power Satellite," *IEEE Antennas and Propagation Magazine*, vol. 47, no. 4, pp. 67-72, August 2005.
- [6] Qiang Chen, Kazuhiro Ozawa, QiaoWei Yuan, and Kunio Sawaya, "Antenna Characterization for Wireless Power-Transmission System Using Near-Field Coupling," *IEEE Antennas and Propagation Magazine*, vol. 54, no. 4, pp. 108-116, Aug. 2012.
- [7] QiaoWei Yuan, Qiang Chen and Kunio Sawaya, "Numerical Analysis on Transmission Efficiency of Evanescent Resonant Coupling Wireless Power Transfer System," *IEEE Transactions on Antennas and Propagation*, vol. 58, no. 5, pp. 1751 - 1758, May 2010.
- [8] QiaoWei Yuan, Mingda Wu, Qiang Chen, and Kunio Sawaya, "Analysis of Near-Field Power Transfer Using Scattering Parameters," *Proc. The 7th European Conference on Antennas and Propagation (EuCAP2013)*, pp. 2965-2967, 2013.