

Comparison of Small-Scale parameters at 60 GHz for Underground Mining and Indoor Environments

Yacouba Coulibaly MIEEE, Gilles Y. Delisle LFIEEE, Nadir Hakem MIEEE
Université du Québec en Abitibi-Témiscamingue (LRTCS)
Val d'Or, Qc, Canada, J9P 1Y3
coulibaly@ieee.org, gilles.delisle@uqat.ca, nadir.hakem@uqat.ca

Abstract—This paper describes the small scale performances of a 60 GHz channel in an underground mine and in an indoor laboratory using the same channel sounder. The frequency domain channel measurements have been carried out in the 59 GHz to 61 GHz frequency band. Based on the measurements, the two environments are characterized and compared in terms of delay spread, coherence bandwidth. The values of the delay spread are less than 3 ns for both environments. Finally a relationship between the delay spread and the coherence bandwidth is found for both scenarios.

Keywords—component; 60 Ghz; Channel; underground; Measurement; Characterization

I. INTRODUCTION

There are currently three main ways of deploying communication network in an underground mine: leaky feeders, fiber optics and wireless communication. Wireless technology is advantageous compared to the others because it can be deployed anywhere, it is generally a low cost option and it is more resilient than wired technology [1]. Wireless technology can be applied to different applications in the mining industry. It can improve the production through automation, increase safety, reduce maintenance costs and allow the transfer of voice, data and video in remote locations of the mine. Additionally, in the context of an underground mine disaster, it is important to have a wireless network in order to facilitate and improve rescue operations. However, in order for wireless communications to be effective, the specific channels must be characterized with the help of measurements; this is sometimes a painstaking work in an underground mining environment. Furthermore, the design of communication systems in this specific industry is a challenge for any engineer as such systems have to operate in confined environments, which are complex and support a variety of applications.

These different applications can require high data rates. As the lower frequency bands used in wireless standard such as WiFi (Wireless Fidelity) and UWB (Ultra Wide Band) have become congested, the 60 GHz ISM frequency band techniques has been proposed as an alternative communication scheme for high data rates [2]. This frequency band is of great interest because of the massive universal unlicensed spectrum available for communication

systems (5-7 GHz). The absorption of the electromagnetic energy is more important at 60 GHz than at lower frequencies used for wireless communications. The signal energy reduces approximately by one half every 200 meters. Therefore, it cannot travel far beyond the intended recipient. Due to high oxygen absorption, the 60 GHz frequency band has a high spatial frequency reuse and it is ideal for high secure short-range wireless communications. The 60 GHz technology can be deployed in indoor and underground environments. Furthermore, it can have a broad range of applications in the underground mining environment. It can be used for the deployment of sensor networks and the transmission of video, the use of high data rate multimedia systems.

Over the last few years, different experimental studies have been carried out to characterize the 60 GHz channel in indoor environments [3-5], cars [6], tunnels [7] and hospitals [8]. However, limited work has been done to characterize and understand the properties of the underground mine radio propagation channel at millimeter frequency and especially at the 60 GHz ISM band for wireless communication systems [9].

An underground mine gallery presents some structural similarities to indoor environments. They both have long corridors, wide halls and intersections. But an underground mine is distinct because it is a confined environment with a curved roof and many other obstacles, such as the walls, the electric wires, the telecommunications cables, the ventilation system and the pipes. Thus, there are slight differences in an underground mine from other indoor environments. Large scale results of an indoor laboratory and an indoor mine have already been compared [9]. The objective of this paper is to characterize a 60 GHz underground mine channel and compare its small scale parameter to those of an indoor laboratory. This paper is organized as follows. Section II gives a brief description of the underground mine environment, the indoor laboratory environment and the measurements procedure. Section III presents the comparison of experimental data in terms of delay spread and coherence bandwidth. Section IV concludes the results of this study.

II. MEASUREMENT TECHNIQUES

A. Measurements environments



Figure 1. Underground mine environment.

The underground measurements were conducted inside a gallery of a real mine, named CANMET (Canadian Center for Minerals and Energy Technology). This mine is located at Val d'Or, which is 520 km north of Montreal, Canada. The gallery is at a level of 70 m underground. Its height, width and length are approximately 2 m, 3 m, and 75 m, respectively. Fig 1 shows the measurement setup inside the underground mine. Indoor measurements were carried out in the CANMET laboratory (Fig.2). It has a width of 4 m, a length 8 m and a height 4m, respectively.



Figure 2. Indoor environment.

B. Measurements setup

For the characterization of the two environments, the same frequency sounder based on a Vector Network Analyzer (VNA), a power divider, a local oscillator, a power amplifier (PA), a low noise amplifier (LNA), frequency multipliers, filters, mixers, cables and antennas have been used. A power divider is used to divide a 2.25 GHz synthesized signal into two channels. The signal of both channel are then multiplied twenty four times to obtain the 54 GHz signals at the local oscillator (LO) output of both mixers. The baseband signal, which is between 5 and 7 GHz, is generated by port 1 of the VNA and then upconverted to frequencies between 59 GHz and 61 GHz. The resultant signal is then passed through a band pass filter

followed by a power amplifier before it is radiated in free space through a directional antenna.

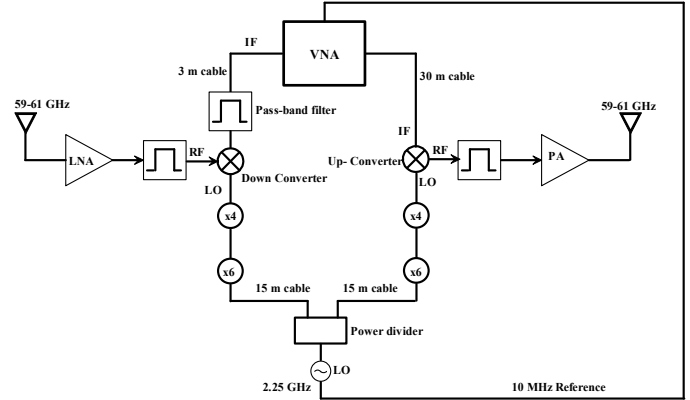

Figure 3. Measurement set-up

The signal received by the same kind of directional antenna, is amplified by a 60 GHz low noise amplifier and then filtered by a 60 GHz bandpass filter. This radio frequency (RF) signal is downconverted to a baseband signal between 5 GHz and 7 GHz. It is also filtered, and connected to the second port of the VNA. The LO at the frequency of 2.25 GHz and the VNA are synchronized through a 10 MHz reference clock.

Both antennas used at the transmission and the reception were vertically polarized directional horn antennas (CERNEX CRA15507520). Their operating frequency bands range from 50-GHz to 75 GHz with a maximum gain of 20 dB. Both half power beamwidths in the azimuth and elevation planes are 12 degrees.

The Agilent E8363 VNA measures the frequency transfer function with 2048 stepped frequency points in the range of 5 GHz to 7 GHz. This gives frequency resolution of 0.97 MHz, a maximum delay of 1.0309 us and the maximum path length of 309 m which is enough for 5m, the maximum distance that separate both the transmitter (TX) and the receiver (RX). A Through Reflect Line (TRL) calibration was done before the measurements. A reference measurement was then performed with the transmitting antenna and receiving antenna 1m apart. The calibration therefore removes the effects of the LNA, the PA, the cables, connectors and antennas from the measured frequency responses.

In order to characterize the propagation channel in small scale, the receiver is moved on a grid square with 9 points (3 X 3) where the distance between each adjacent point is equal to 2.50 cm, which is half of the wavelength in free space at the frequency of the 60 GHz. The antenna is accurately moved on this virtual array by using a VELMEX positioning system. A laser beam has been used to fix the height of the antennas from the ground at 1.5 meters. The measurements were done in light of sight (LOS) for a transmitter-receiver distance of 1 m to 4 m in the two

environments. All measurements were done in the middle of the gallery and the laboratory. All measurements were performed with minimal human movement and activity. In all cases, ten consecutive sweeps were averaged at each distance to obtain an important statistical data of the channel and to also reduce the effects of random noise

III. RESULTS

A. Delay spread

In an underground environment, the presence of multipath components is considerably important due to the reflection and scattering from the ground and surrounding rough surfaces. Multiple paths, with various delays, will cause intersymbol interference (ISI). This ISI is a limiting factor of the maximum data rates of a communication system. The RMS delay spread can give the maximum data rate of the channel without using other measures such as channel equalization.

$$\tau_{rms} = \sqrt{\frac{\sum_k a_k^2 \cdot \tau_k^2}{\sum_k a_k^2} - \left(\frac{\sum_k a_k^2 \cdot \tau_k}{\sum_k a_k^2}\right)^2} \quad (1)$$

The delay spreads are calculated according to equation (1) by taking the multipath components excess delay τ_k with amplitude a_k within 30 dB threshold of the peak value of the power delay profile (PDP). This threshold can be selected because most of the energy of the different PDP is taken in consideration. The comparison of the delay spread of the underground mine and the indoor laboratory is plotted on Fig 4. It can be seen that, for the underground mine and the indoor laboratory, that the delay spread varies from 2.49 ns to 6.75 ns and from 0.17 ns to 2.48 ns, respectively. The average values for the mine and the laboratory are 3.61 ns and 0.78 ns, respectively.

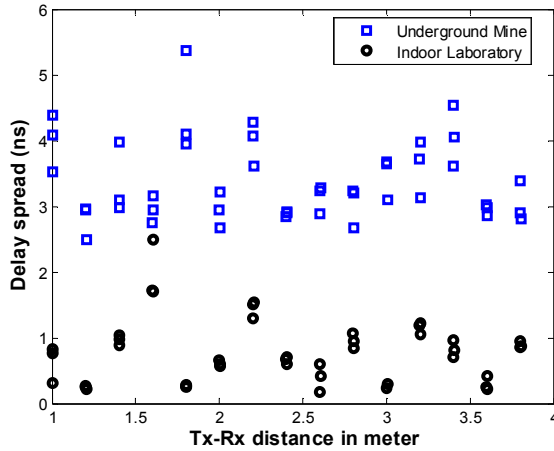

Figure 4. Delay spread in both environments.

These low values of the RMS delay spread are due to the confinement of the electromagnetic waves in the room and the laboratory. At 60 GHz, the diffraction, the scattering and the penetration of the electromagnetic waves around the obstacles are considerably reduced. It can also notice that the

delay spread is not correlated to the transmitter-receiver distance.

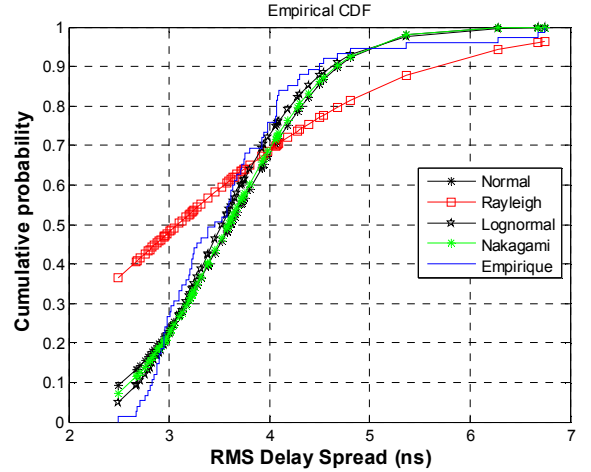

Figure 5. Cumulative distribution of the RMS delay spread in the underground mine and different distributions.

The cumulative distribution function of the delay spread for the underground mine with a threshold of 30 dB has been plotted in Fig. 5. This measured data is fitted to a normal, lognormal, Raleigh, and Nakagami distributions in order to find the one which represents the best the measured data. The Aikake Information Criterion (AIC), which is a method applied to evaluate the goodness of a statistical fit, was used. Fig 5 also shows the CDF of the measured with the fitted distribution functions. The lognormal distribution, which has the lowest AIC, is the best fit for the measured data.

B. Coherence bandwidth

The coherence bandwidth (B_c) is one metric which can be obtained from from the frequency domain characterization. It is the the frequency range over which the channel amplitudes are correlated. It is obtained from the the autocorrelation function of the measured frequency response.

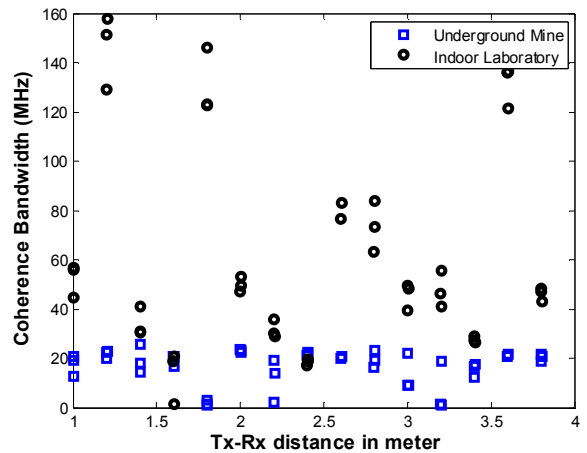

Figure 6. Coherence bandwidth spread in both environments.

Fig.6 shows the Bc for the two environments when the autocorrelation has dropped to 90% of the peak value. This difference is due to the fact there are less diffraction and scattering in the indoor environment. The coherence bandwidth can be related to the delay spread in a heuristic way. The mathematical form of this equation is :

$$B_{coh,0.9} (GHz) = \frac{A}{\tau_{rms}(ns)} \quad (2)$$

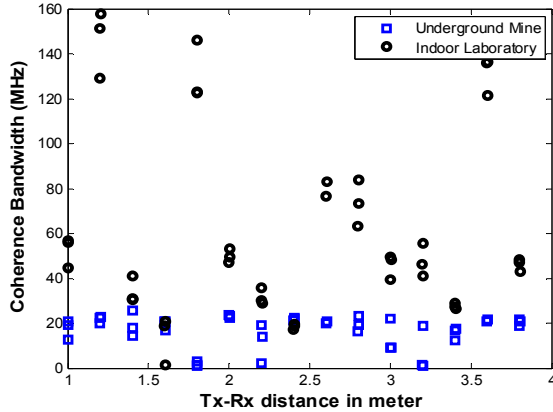

Figure 7. Coherence bandwidth spread in both environments.

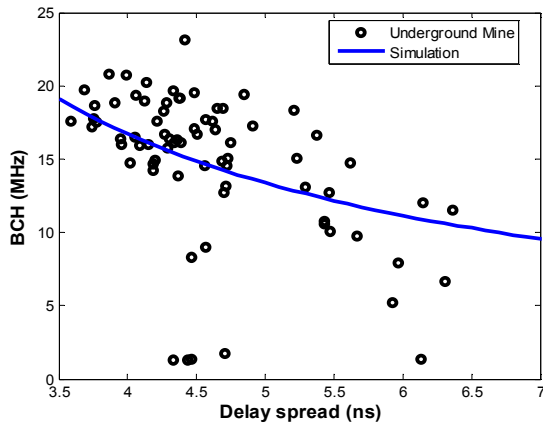

Figure 8. Coherence bandwidth as a function of the delay spread for the underground mine.

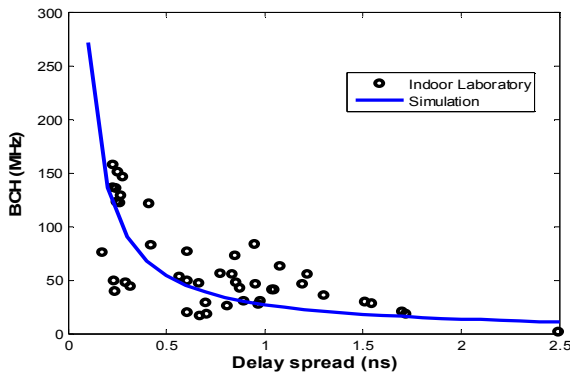

Figure 9. Coherence bandwidth as a function of the delay spread for the indoor laboratory.

This can be used to deduce the coherence bandwidth from the RMS delay spread and vice versa when one set of values are known. The values of 0.06 [10], 0.063 [3] and 0.285 [2,8] have all been found in the literature. Fig. 7 and Fig. 8 show the coherence bandwidth as a function of the corresponding delay spread for the underground mine and the laboratory, respectively. The values of the constant A are found to be 0.054, and 0.027, for the underground mine and the laboratory, respectively.

IV. CONCLUSION

This paper has presented the small scale results for the 60 GHz propagation for an underground mining environment and an indoor environment. Measurements were taken in a line of sight case over 4 m using directional horn antennas. The confinement of the electromagnetic wave is visible in both environments. This results in low values of the delay as the diffraction, the scattering and the penetration of the wave around the obstacles are reduced. The delay spread varies between 2.49 ns and 6.75 ns with a mean value of 3.24 ns for the underground mine with a threshold of 30 dB. The lognormal distribution represents best the RMS delay spread in this situation. For both scenarios, a relationship is found between the delay spread and coherence bandwidth

REFERENCES

- [1] S. Outalha, R. Le, P.M. Tardif, "Toward a unified and digital communication system for underground mines", *Revue of Canadian Institute of Mining, Metallurgy and Petroleum*, Vol. 93, No. 1044, pp. 100-105, 2000.
- [2] Su-Khiong Yong, Pengfei Xia, Alberto Valdes-Garcia, 60 GHz technology for GBPS WLAN and WPAN. From theory to practice, John Wiley & Sons Ltd, 2011, pp.3-61.
- [3] P. F.M. Smulders, "Statistical Characterization of 60 GHz Indoor Radio," *IEEE Transactions on Antennas and Propagation*, Vol. 57, No. 10, October 2009.
- [4] N. Moraitis, P. Constantinou, "Indoor channel Measurements and Characterization at 60GHz for wireless local area network," *IEEE transactions on Antennas and Propagation*, Vol. 52, No. 12, December 2004.
- [5] S. Geng, J. Kivinen, X. Zhao, P. Vainikainen, "Millimeter-wave propagation channel characterization for short-range wireless communications," *IEEE Transactions on Vehicular Technology*, Vol. 58, No. 1, January 2009, pp.1-7.
- [6] M. Schack, M. Jacob, and T.Kurner, "Comparison of in-car UWB and 60 GHz channel measurements," *Third European Conference on Antennas and Propagation*, pp.640-644, 2009.
- [7] N. Prediger and A. Plattner, "Propagation measurements at 60 GHz in railroad tunnels," in *Proc. IEEE MTT-S International Symposium Propagation*, pp.1085-1087, 1994.
- [8] M. Kyro, K. Haneda, J. Simola ; K. Nakai ; K. Takizawa ; H. Hagiwara and P. Vainikainen, " Measurement Based Path Loss and Delay Spread Modeling in Hospital Environments at 60 GHz ", *Wireless Communications*, *IEEE Transactions*, Vol 10, No 8, pp. 2423-2427, Aug 2011.
- [9] C. Lounis ; N. Hakem ; G. Y. Delisle and Y. Coulibaly " Large-scale characterization of an underground mining environment for the 60 GHz frequency band," in *Proc. IEEE ICWCUCA,Clermont Ferrand, France*, August 2012, pp.1-4, 2012.
- [10] T. Zwick, T. J. Beukema, and H. Nam, "Wideband channel sounderwith measurementsand model for the 60 GHz indoor channel radio," *IEEE Trans. Veh. Technol.*, vol. 54, no. 4, pp. 1266-1276, 2005
- [11] N. Moraitis, " Measurements and Characterization at 60GHz of wideband indoor radio channel at 60 GHz," *IEEE Trans. Wireless Commun.*, vol. 5, no. 4, pp. 880-889, Apr. 2006